

HF SERIES

Precision 3 piece construction provides steel on bronze contact for lubricity, smoother operation, and provides long dynamic life.

Material

Ball: 52100/Hard Chrome Plated

Body: Carbon Steel Zinc Plated

Race: Sintered Oil Impregnated Bronze

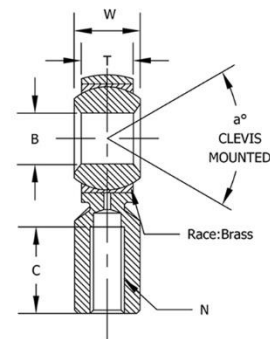
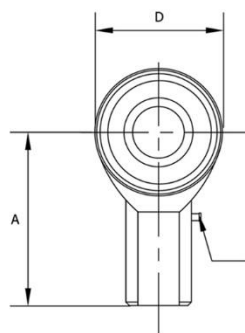

Applications:

Precision Machinery

Industrial Equipment

Farm Machinery

Truck/Bus/Off Highway Vehicles

Recreational Vehicles



Female Rod Ends		B Dia.	D Dia.	W Width	T Width	Ball Dia.	A Length	N Thread	C Length	E Dia.	F Flat	a° Mis. Angle	Ult. Static Radial Load (lbs)	Approx. Weight (lbs)
Right Hand Part No.	Left Hand Part No.	+0.0015 -0.0005	+0.010 -0.010	+0.005 -0.005	+0.015 -0.015	Ref.	+0.015 -0.015	UNF 2B	+0.062 -0.031	+0.010 -0.010	+0.010 -0.010	Ref.		
HF 3	HFL 3	0.1900	0.625	0.312	0.250	0.437	1.062	10-32	0.500	0.406	0.312	13	1,624	0.04
HF 4	HFL 4	0.2500	0.750	0.375	0.281	0.500	1.312	1/4-28	0.687	0.468	0.375	16	2,545	0.06
HF 5	HFL 5	0.3125	0.875	0.437	0.344	0.625	1.375	5/16-24	0.687	0.500	0.437	14	3,200	0.09
HF 6	HFL 6	0.3750	1.000	0.500	0.406	0.719	1.625	3/8-24	0.812	0.687	0.562	12	3,950	0.15
HF 7	HFL 7	0.4375	1.250	0.562	0.437	0.812	1.812	7/16-20	0.937	0.750	0.625	14	4,300	0.20
HF 8	HFL 8	0.5000	1.312	0.625	0.500	0.937	2.125	1/2-20	1.062	0.875	0.750	12	6,700	0.33
HF 10	HFL 10	0.6250	1.500	0.750	0.562	1.125	2.500	5/8-18	1.375	1.000	0.875	16	7,400	0.48
HF 12	HFL 12	0.7500	1.750	0.875	0.687	1.312	2.875	3/4-16	1.562	1.1250	1.000	14	11,550	0.72

Available in Re-Lubricable design - Add G Suffix (HF 6G)

Interchanges/Equivalents:

TRITAN	Heim	Aurora	SealMaster/Spherco	Cablecraft	Alinabal
HF 8	HF8	MW-8	TR8	DBF8	VXF-8-G
HF 8G	HF8G	MW-8Z	TR8N	DBF8Z	VXF-8-G-8
HFL 8	HFL8	MG-8	TRL8	DBFL8	VXFL-8-G
HFL 8G	HFL8G	MG-8Z	TRL8N	DBFL8Z	VXFL-8-G-8

US Corporate Headquarters:

2100 Pacific Street
Hauppauge NY, 11788
www.tritanpt.com



Exclusively Distributed by:



888-4-Bearings

HM SERIES

Precision 3 piece construction provides steel on bronze contact for lubricity, smoother operation, and provides long dynamic life.

Material

Ball: 52100/Hard Chrome Plated
 Body: Carbon Steel Zinc Plated
 Race: Sintered Oil Impregnated Bronze

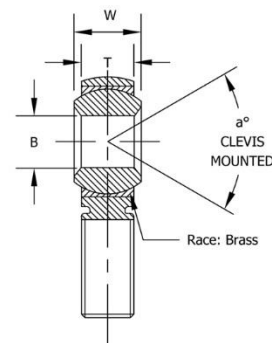
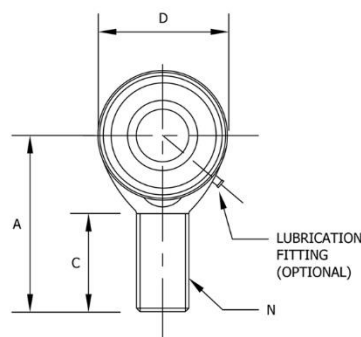

Applications:

Precision Machinery
 Industrial Equipment
 Farm Machinery
 Truck/Bus/Off Highway Vehicles
 Recreational Vehicles



Male Rod Ends		B Dia.	D Dia.	W Width	T Width	Ball Dia.	A Length	N Thread	C Length	a° Mis. Angle	Ult. Static Radial Load (lbs)	Approx. Weight (lbs)
Right Hand Part No.	Left Hand Part No.	+0.0015 -0.0005	+0.010 -0.010	+0.005 -0.005	Ref.	Ref.	+0.015 -0.015	UNF 3A	+0.062 -0.031	Ref.		
HM 3	HML 3	0.1900	0.625	0.312	0.250	0.437	1.250	10-32	0.750	13	1,174	0.03
HM 4	HML 4	0.2500	0.750	0.375	0.281	0.500	1.562	1/4-28	1.000	16	2,168	0.04
HM 5	HML 5	0.3125	0.875	0.437	0.344	0.625	1.875	5/16-24	1.250	14	2,796	0.07
HM 6	HML 6	0.3750	1.000	0.500	0.406	0.719	1.938	3/8-24	1.250	12	4,012	0.11
HM 7	HML 7	0.4375	1.125	0.562	0.437	0.812	2.125	7/16-20	1.375	14	4,244	0.16
HM 8	HML 8	0.5000	1.312	0.625	0.500	0.937	2.438	1/2-20	1.500	12	6,700	0.25
HM 10	HML 10	0.6250	1.500	0.750	0.562	1.125	2.625	5/8-18	1.625	16	7,400	0.38
HM 12	HML 12	0.7500	1.750	0.875	0.687	1.312	2.875	3/4-16	1.750	14	11,550	0.60

Available in Re-Lubricable design - Add G Suffix (HM 6G)

Interchanges/Equivalents:

TRITAN	Heim	Aurora	SealMaster/Spherco	Cablecraft	Alinabal
HM 8	HM8	MM-8	TRE8	DBM8	VXM-8-G
HM 8G	HM8G	MM-8Z	TRE8N	DBM8Z	VXM-8-G-8
HML 8	HML8	MB-8	TREL8	DBML8	VXML-8-G
HML 8G	HML8G	MB-8Z	TREL8N	DBML8Z	VXML-8-G-8

US Corporate Headquarters:
 2100 Pacific Street
 Hauppauge NY, 11788
www.tritanpt.com



Exclusively Distributed by:



888-4-Bearings

CF SERIES

2 piece metal on metal construction offers the most economical design for a wide range of light to heavy duty motion transfer applications.

Material

Ball: 52100/Hard Chrome Plated
Body: Carbon Steel Zinc Plated

Applications:

Construction Machinery
Industrial Equipment
Lawn & Garden Applications
Truck/Bus/Off Highway Vehicles
Recreational Vehicles

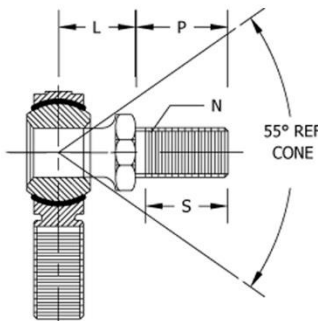
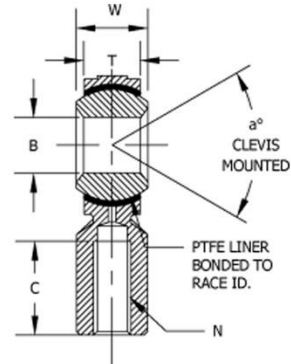
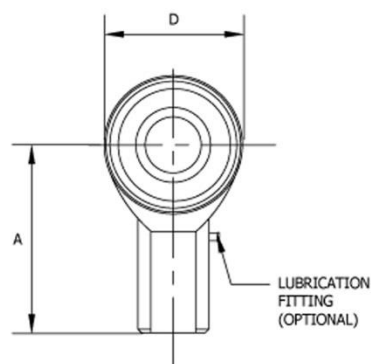

Studded Dimensions				
Rod End Bore Size	L REF	P +/- .030	S Min. Thread Length	N Thread Size UNF-2A
1/4"	0.469	0.563	0.500	1/4-28
5/16"	0.531	0.688	0.594	5/16-24
3/8"	0.625	0.875	0.781	3/8-24
1/2"	0.875	1.125	1.000	1/2-20
5/8"	1.000	1.125	1.000	5/8-18

Female Rod Ends		B Dia.	D Dia.	W Width	T Width	Ball Dia.	A Length	N Thread	C Length	E Dia.	F Flat	a° Mis. Angle	Ult. Static Radial Load (lbs)	Approx. Weight (lbs)
Right Hand Part No.	Left Hand Part No.	+0.0025 -0.0005	+0.010 -0.010	+0.005 -0.005	Ref.	Ref.	+0.015 -0.015	UNF 2B	+0.062 -0.031	+0.010 -0.010	+0.010 -0.010	Ref.		
CF 3	CFL 3	0.1900	0.625	0.312	0.234	0.437	1.062	10-32	0.500	0.406	0.312	20	2,000	0.04
CF 4	CFL 4	0.2500	0.750	0.375	0.250	0.500	1.312	1/4-28	0.687	0.468	0.375	27	3,250	0.05
CF 5	CFL 5	0.3125	0.875	0.437	0.312	0.625	1.375	5/16-24	0.687	0.500	0.437	22	3,934	0.08
CF 6	CFL 6	0.3750	1.000	0.500	0.359	0.719	1.625	3/8-24	0.812	0.687	0.562	22	5,100	0.13
CF 7	CFL 7	0.4375	1.125	0.562	0.406	0.812	1.812	7/16-20	0.937	0.750	0.625	21	6,420	0.18
CF 8	CFL 8	0.5000	1.312	0.625	0.453	0.937	2.125	1/2-20	1.062	0.875	0.750	20	9,100	0.29
CF 10	CFL 10	0.6250	1.500	0.750	0.484	1.125	2.500	5/8-18	1.375	1.000	0.875	26	9,800	0.43
CF 12	CFL 12	0.7500	1.750	0.875	0.593	1.312	2.875	3/4-16	1.562	1.125	1.000	24	14,250	0.65

Available with Stud - Add Suffix 'S' (CF 8S), or Maintenance Free/PTFE lined - Add suffix 'T' (CF 8T).

Interchanges/Equivalents:

TRITAN	Heim	SealMaster/Spherco	Alinabal	Aurora	FK	Cablecraft
CF 8	F8CR	CFF8	AF-8-GP	CW-8	CF8/ECF8	EF 8
CF 8T	CFHD 8	CFF8T	PF-8-G	VCW-8	CF8T	CF8T
CF 8S	F8CRY	CFF8Y	AFS-8-GP	CW-8S	CF8Y	EF 8S
CF 8TS	CFHDY 8	CFF8TY	PFS-8-G	VCW-8S	CF8TY	CF8TS

US Corporate Headquarters:
2100 Pacific Street
Hauppauge NY, 11788
www.tritanpt.com



Exclusively Distributed by:



888-4-Bearings

CM SERIES

2 piece metal on metal construction offers the most economical design for a wide range of light to heavy duty motion transfer applications.

Material

Ball: 52100/Hard Chrome Plated
Body: Carbon Steel Zinc Plated

Applications:

Construction Machinery
Industrial Equipment
Lawn & Garden Applications
Truck/Bus/Off Highway Vehicles
Recreational Vehicles

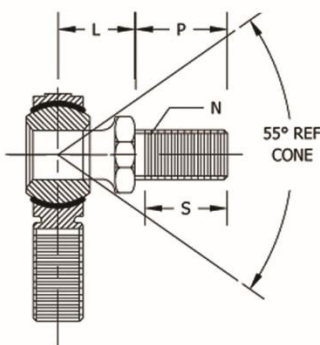
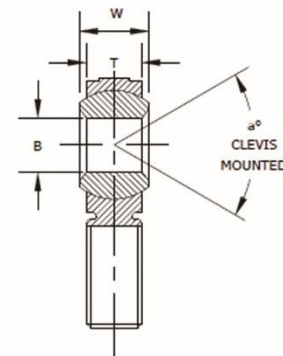
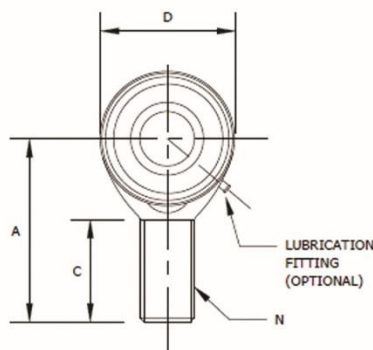

Studded Dimensions				
Rod End Bore Size	L REF	P +/- .030	S Min. Thread Length	N Thread Size UNF-2A
1/4"	0.469	0.563	0.500	1/4-28
5/16"	0.531	0.688	0.594	5/16-24
3/8"	0.625	0.875	0.781	3/8-24
1/2"	0.875	1.125	1.000	1/2-20
5/8"	1.000	1.125	1.000	5/8-18

Male Rod Ends		B Dia.	D Dia.	W Width	T Width	Ball Dia.	A Length	N Thread	C Length	a° Mis. Angle	Ult. Static Radial Load (lbs)	Approx. Weight (lbs)
Right Hand Part No.	Left Hand Part No.	+0.0025 -0.0005	+0.10 -0.10	+0.005 -0.005	Ref.	Ref.	+0.015 -0.015	UNF 3A	+0.062 -0.031	Ref.		
CM 3	CML 3	0.1900	0.625	0.312	0.234	0.437	1.250	10-32	0.750	20	1,210	0.03
CM 4	CML 4	0.2500	0.750	0.375	0.250	0.500	1.562	1/4-28	1.000	27	2,225	0.04
CM 5	CML 5	0.3125	0.875	0.437	0.312	0.625	1.875	5/16-24	1.250	22	3,600	0.07
CM 6	CML 6	0.3750	1.000	0.500	0.359	0.719	1.938	3/8-24	1.250	22	5,100	0.11
CM 7	CML 7	0.4375	1.125	0.562	0.406	0.812	2.125	7/16-20	1.375	21	6,402	0.15
CM 8	CML 8	0.5000	1.312	0.625	0.453	0.937	2.438	1/2-20	1.500	20	8,386	0.24
CM 10	CML 10	0.6250	1.500	0.750	0.484	1.125	2.625	5/8-18	1.625	26	9,813	0.36
CM 12	CML 12	0.7500	1.750	0.875	0.593	1.312	2.875	3/4-16	1.750	24	14,290	0.57

Available with Stud - Add Suffix 'S' (CM 8S), or Maintenance Free/PTFE lined - Add suffix 'T' (CM 8T).

Interchanges/Equivalents:

TRITAN	Heim	SealMaster/Spherco	Alinabal	Aurora	FK	Cablecraft
CM 8	M8CR	CFM8	AM-8-GP	CM-8	CM8/ECM8	EM8
CM 8T	CMHD8	CFM8T	PM-8-G	VCM-4	CM8T	CM8T
CM 8S	M8CRY	CFM8Y	AMS-4-GP	CM-8S	CM8Y/ECM8Y	EM8S
CM 8TS	CMHD8Y	CFM8TY	PMS-4G	VCM-8S	CM8TY	CM8TS

US Corporate Headquarters:
2100 Pacific Street
Hauppauge NY, 11788
www.tritanpt.com



Exclusively Distributed by:



888-4-Bearings