



# SPAW/SPW/SFCW Heavy-Duty Bearing Units



**INDUSTRIAL SOLUTIONS**™

9400 W. 55th Street • Merriam, KS 66203  
Phone: 913.677.3151 • [www.ibtinc.com](http://www.ibtinc.com)

CAT. No. C-2600-V

# Heavy loads and contamination require heavy duty protection.

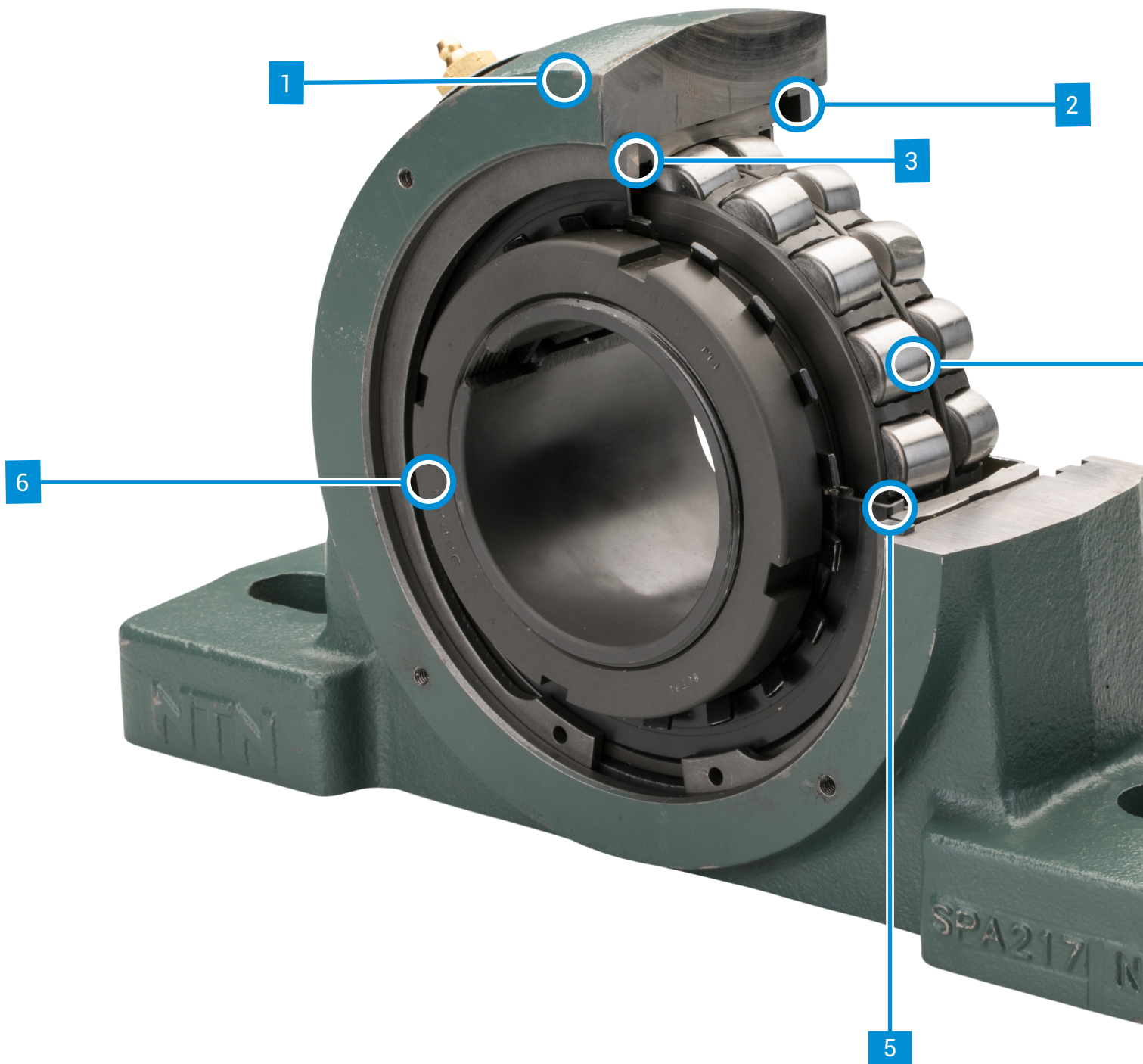

# The Better Option

Less downtime.  
More profitability.

NTN SPAW/SPW Heavy Duty Spherical Roller Bearing Units have been designed and tested to provide superior performance in applications with heavy contamination concerns. These are easy-to-install SAF/SN replacement units that are factory sealed, pre-lubricated, and assembled.

## Product Features & Benefits

- 1 One-piece, sturdy ductile iron housing to withstand high shock and impact from falling debris
- 2 Repositionable snap ring allows for versatile fixed or float unit
- 3 Spring-loaded, single-lip contact bearing seal for superior sealing
- 4 Bearings with super-finished rollers for less noise, and raceway designs that accommodate higher misalignment
- 5 Unitized bearing insert allows for easy replacement
- 6 Phosphate-coated locknut/adaptor sleeve for secure mounting and corrosion protection



4

# Table of Contents

NOMENCLATURE SYSTEM.....	5
ORDERING INFORMATION.....	5
SPAW DIMENSIONAL DETAIL .....	6
SPAW DIMENSIONAL DETAIL .....	7
SPW DIMENSIONAL DETAIL .....	8
SPW DIMENSIONAL DETAIL .....	9
SFCW DIMENSIONAL DETAIL .....	10
SFCW DIMENSIONAL DETAIL .....	11
INSTALLATION INSTRUCTIONS .....	12
SPAW/SPW/SFCW TECHNICAL INFORMATION.....	13
SPAW/SPW/SFCW ENGINEERING.....	14
SPAW/SPW/SFCW ENGINEERING.....	15
SPAW/SPW/SFCW COMPONENTS.....	16
SPAW/SPW/SFCW ACCESSORIES.....	17

# Heavy Duty Block Nomenclature System

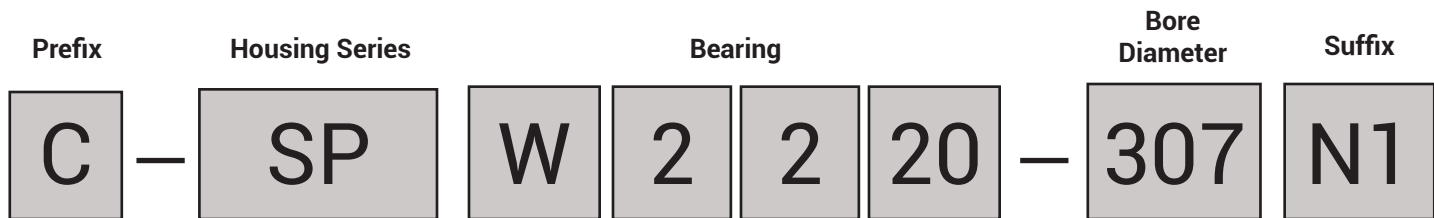

## 1. PREFIX

- No symbol: Standard unit with sealed spherical roller bearing insert
- C: 2 open end covers (SFC housing with one cover only)
- CM: 1 open end cover, 1 closed end cover (SFC housing with end cover only)

## 2. HOUSING

- SP: Pillow block unit to SN housing dimensions
- SPA: Pillow block unit to SAF housing dimensions (SP and SPA only) Ductile iron
- FSPA: Pillow block unit to SAF housing dimensions Ductile iron, 4 bolt
- SFC: 4 bolt piloted circular flange block for two or four bolt arrangement

## 3. BEARING

- W22xx: MX-W222xx series sealed spherical roller bearing

## 4. BORE DIAMETER (-Xnn)

- No value: Metric bore sizing (see tables)
- X: Number of inches
- nn: Number of 1/16 inches  
eg.: -307 indicates a 3 7/16" bore

## 5. SUFFIX

- N1: Ductile iron housing (Standard)
- FN1: (SP and SPA only) Ductile iron housing with solid base and indents for two or four bolt arrangement

## How To Order Your Ideal Bearing Unit

### SPAW

Example: When you order one SPAW2220-307N1, you will receive an assembly consisting of one SPA220N1 Pillow Block Housing, one MX-W22220EALLKW33C3 Bearing, and one HA2320M1 Adapter.

When C-SPAW2220N1 or CM-SPAW2220N1 are specified, external covers will be supplied with the unit.

Example: "C" prefix – 2 open end covers  
"CM" prefix – 1 open end cover, 1 closed end cover

### SPW

Example: When you order one SPW2220N1, you will receive an assembly consisting of one SP220N1 Pillow Block Housing, one MX-W22220EALLKW33C3 Bearing, and one H2320XM1 Adapter.

To order a solid base housing, add suffix F to the part number (example: SPW2220FN1).

When C-SPW2220N1 or CM-SPW2220N1 are specified, external covers will be supplied with the unit.

Example: "C" prefix – 2 open end covers  
"CM" prefix – 1 open end cover, 1 closed end cover

### SFCW

Example: When you order one SFCW2220N1, you will receive an assembly consisting of one SFC220N1 Flange Block Housing, one MX-W22220EALLKW33C3 Bearing, and one H2320XM1 Adapter.

When C-SFCW2220N1 or CM-SFCW2220N1 are specified, external covers will be supplied with the unit.

Example: "C" prefix – 1 open end cover  
"CM" prefix – 1 closed end cover

- Notes:– Open end cover service seals for which dimensions are shown are standard. For dimensions and availability of non-standard taconite service seals, consult NTN Engineering.
- All units are supplied in float arrangement and may be converted to fixed by relocation of a snap ring.
  - All bearing inserts are supplied pre-lubricated with multi-purpose industrial bearing grease.
  - Solid base housings may be drilled for 2 or 4 bolt arrangement.
- Grease fittings are provided with all units.



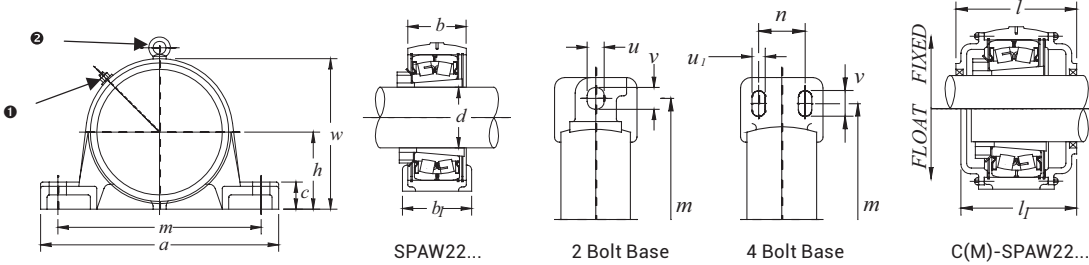

Units	Shaft Dia.
Metric	50 - 140 mm
Standard	1 <sup>15</sup> / <sub>16</sub> - 5 <sup>1</sup> / <sub>2</sub> in

SEALED SPHERICAL PILLOW BLOCKS – INCH SERIES

Shaft Dia. d	Part Number	Nominal Dimensions												
		h	a	b	b <sub>1</sub>	c	m	n	w	l	l <sub>1</sub>	u	u <sub>1</sub>	v
50	SPA2211N1													
1 <sup>15</sup> / <sub>16</sub>	SPA2211-115N1	2 <sup>3</sup> / <sub>4</sub>	9.606	2.441	2.756	1.102	7 <sup>5</sup> / <sub>8</sub>	-	5.354	4.724	4.488	0.709	-	7 <sup>7</sup> / <sub>8</sub>
2	SPA2211-200N1													
60	SPA2213N1											0.709	-	
2 <sup>3</sup> / <sub>16</sub>	FSPA2213N1											-	0.591	
2 <sup>3</sup> / <sub>16</sub>	SPA2213-203N1											0.709	-	
2 <sup>1</sup> / <sub>4</sub>	FSPA2213-203N1	3	10.827	2.756	3.110	1.024	8 <sup>13</sup> / <sub>16</sub>	2	6.024	5.433	4.961	-	0.591	1 <sup>5</sup> / <sub>16</sub>
2 <sup>1</sup> / <sub>4</sub>	SPA2213-204N1											0.709	-	
2 <sup>3</sup> / <sub>8</sub>	FSPA2213-204N1											-	0.591	
2 <sup>3</sup> / <sub>8</sub>	SPA2213-206N1											0.709	-	
2 <sup>3</sup> / <sub>8</sub>	FSPA2213-206N1											-	0.591	
65	SPA2215N1											0.709	-	
2 <sup>7</sup> / <sub>16</sub>	FSPA2215N1											-	0.591	
2 <sup>7</sup> / <sub>16</sub>	SPA2215-207N1	3 <sup>1</sup> / <sub>4</sub>	11.024	2.835	3.110	1.299	9 <sup>1</sup> / <sub>8</sub>	1 <sup>7</sup> / <sub>8</sub>	6.535	5.197	4.843	0.709	-	1 <sup>1</sup> / <sub>8</sub>
2 <sup>7</sup> / <sub>16</sub>	FSPA2215-207N1											-	0.591	
2 <sup>1</sup> / <sub>2</sub>	SPA2215-208N1											0.709	-	
2 <sup>1</sup> / <sub>2</sub>	FSPA2215-208N1											-	0.591	
75	SPA2217N1											0.866	-	
2 <sup>15</sup> / <sub>16</sub>	FSPA2217N1											-	0.709	
2 <sup>15</sup> / <sub>16</sub>	SPA2217-215N1	3 <sup>3</sup> / <sub>4</sub>	12.598	3.150	3.504	1.260	10 <sup>7</sup> / <sub>16</sub>	2 <sup>1</sup> / <sub>8</sub>	7.559	6.142	5.748	0.866	-	1 <sup>5</sup> / <sub>16</sub>
2 <sup>15</sup> / <sub>16</sub>	FSPA2217-215N1											-	0.709	
3	SPA2217-300N1											0.866	-	
3	FSPA2217-300N1											-	0.709	
90	SPA2220N1											1.024	-	
3 <sup>7</sup> / <sub>16</sub>	FSPA2220N1											-	0.866	
3 <sup>7</sup> / <sub>16</sub>	SPA2220-307N1	4 <sup>1</sup> / <sub>2</sub>	14.961	3.740	4.331	1.654	12 <sup>3</sup> / <sub>8</sub>	2 <sup>3</sup> / <sub>8</sub>	8.976	7.283	6.890	1.024	-	1 <sup>5</sup> / <sub>8</sub>
3 <sup>7</sup> / <sub>16</sub>	FSPA2220-307N1											-	0.866	
3 <sup>1</sup> / <sub>2</sub>	SPA2220-308N1											1.024	-	
3 <sup>1</sup> / <sub>2</sub>	FSPA2220-308N1											-	0.866	
100	SPA2222N1													
3 <sup>15</sup> / <sub>16</sub>	SPA2222-315N1	4 <sup>15</sup> / <sub>16</sub>	16.496	3.937	4.764	1.772	13 <sup>9</sup> / <sub>16</sub>	2 <sup>3</sup> / <sub>4</sub>	10.315	7.795	7.283	-	0.866	1 <sup>11</sup> / <sub>16</sub>
3 <sup>15</sup> / <sub>16</sub>	SPA2222-400N1													
110	SPA2224N1													
4 <sup>3</sup> / <sub>16</sub>	SPA2224-403N1	5 <sup>1</sup> / <sub>4</sub>	16.496	4.134	4.764	1.496	13 <sup>7</sup> / <sub>8</sub>	2 <sup>3</sup> / <sub>4</sub>	10.512	7.992	7.480	-	0.866	1 <sup>3</sup> / <sub>8</sub>
4 <sup>3</sup> / <sub>16</sub>	SPA2224-404N1													
4 <sup>1</sup> / <sub>4</sub>	SPA2224-404N1													
115	SPA2226N1													
4 <sup>7</sup> / <sub>16</sub>	SPA2226-407N1	6	18.386	4.528	5.118	2.047	15 <sup>5</sup> / <sub>16</sub>	3 <sup>1</sup> / <sub>4</sub>	11.614	8.622	8.110	-	0.945	1 <sup>9</sup> / <sub>16</sub>
4 <sup>7</sup> / <sub>16</sub>	SPA2226-408N1													
125	SPA2228N1													
4 <sup>15</sup> / <sub>16</sub>	SPA2228-415N1	6	20.118	4.724	5.866	2.047	16 <sup>9</sup> / <sub>16</sub>	3 <sup>3</sup> / <sub>8</sub>	12.087	9.134	8.622	-	1.024	1 <sup>9</sup> / <sub>16</sub>
4 <sup>15</sup> / <sub>16</sub>	SPA2228-500N1													
140	SPA2232N1													
5 <sup>7</sup> / <sub>16</sub>	SPA2232-507N1	6 <sup>11</sup> / <sub>16</sub>	22.008	5.315	6.260	2.362	18 <sup>5</sup> / <sub>16</sub>	3 <sup>3</sup> / <sub>4</sub>	13.386	10.236	9.724	-	1.024	1 <sup>15</sup> / <sub>16</sub>
5 <sup>7</sup> / <sub>16</sub>	SPA2232-508N1													

How to Order

Example: When you order one SPAW2220-307N1, you will receive an assembly consisting of one SPA220N1 Pillow Block Housing, one MX-W22220EALLKW33C3 Bearing, and one HA2320M1 Adapter.

When C-SPAW2220N1 or CM-SPAW2220N1 are specified, external covers will be supplied with the unit.

Example: "C" prefix – 2 open end covers

"CM" prefix – 1 open end cover, 1 closed end cover

- Notes: – Open end cover service seals for which dimensions are shown are standard.  
 For dimensions and availability of non-standard taconite service seals, consult NTN Engineering.  
 – All units are supplied in float arrangement and may be converted to fixed by relocation of a snap ring.  
 – All bearing inserts are supplied pre-lubricated with multi-purpose industrial bearing grease.

Grease fittings are provided with all units.

An eye bolt is provided on housings SPA228N1 and SPA232N1.

SEALED SPHERICAL PILLOW BLOCKS – INCH SERIES (continued)

	Set Bolts		Insert Number	Basic Load Rating (lbs/N)		Limiting Speed (rpm)	Housing Number	Adapter	Part Number
	2 req'd	4 req'd		Dynamic C	Static CO	nmax			
	5/8		MX-W22211EALLKW33C3	34,850 155,000	33,270 148,000	2,700	SPA211N1	H2311XM1 HA2311M1 HE2311XYM1	SPAW2211N1 SPAW2211-115N1 SPAW2211-200N1
	5/8	1/2	MX-W22213EALLKW33C3	50,800 226,000	50,350 224,000	2,300	SPA213N1	H2313XM1	SPAW2213N1
	5/8						FSPA213N1	H2313XM1	FSPAW2213N1
	5/8	1/2					SPA213N1	HA2313M1	SPAW2213-203N1
	5/8						FSPA213N1	HA2313M1	FSPAW2213-203N1
	5/8	1/2					SPA213N1	HE2313XM1	SPAW2213-204N1
	5/8		FSPA213N1	HE2313XM1	FSPAW2213-204N1				
	5/8	1/2	SPA213N1	HS2313XM1	SPAW2213-206N1				
	5/8		FSPA213N1	HS2313XM1	FSPAW2213-206N1				
	5/8	2	MX-W22215EALLKW33C3	54,850 244,000	55,975 249,000	2,000	SPA215N1	H2315XM1	SPAW2215N1
	5/8	1/2					FSPA215N1	H2315XM1	FSPAW2215N1
	5/8						SPA215N1	HA2315M1	SPAW2215-207N1
	5/8	1/2					FSPA215N1	HA2315M1	FSPAW2215-207N1
	5/8		SPA215N1	HE2315XM1	SPAW2215-208N1				
	5/8	1/2	FSPA215N1	HE2315XM1	FSPAW2215-208N1				
	3/4	5/8	MX-W22217EALLKW33C3	72,825 324,000	74,200 330,000	1,800	SPA217N1	H2317XM1	SPAW2217N1
	3/4						FSPA217N1	H2317XM1	FSPAW2217N1
	3/4	5/8					SPA217N1	HA2317XM1	SPAW2217-215N1
	3/4						FSPA217N1	HA2317XM1	FSPAW2217-215N1
	3/4	5/8	SPA217N1	HE2317XM1	SPAW2217-300N1				
	3/4		FSPA217N1	HE2317XM1	FSPAW2217-300N1				
	7/8	3/4	MX-W22220EALLKW33C3	106,100 472,000	111,275 495,000	1,500	SPA220N1	H2320XM1	SPAW2220N1
	7/8						FSPA220N1	H2320XM1	FSPAW2220N1
	7/8	3/4					SPA220N1	HA2320M1	SPAW2220-307N1
	7/8						FSPA220N1	HA2320M1	FSPAW2220-307N1
	7/8	3/4	SPA220N1	HE2320XM1	SPAW2220-308N1				
	7/8		FSPA220N1	HE2320XM1	FSPAW2220-308N1				
	3/4		MX-W22222EALLKW33C3	135,325 602,000	144,550 643,000	1,400	SPA222N1	H2322XM1	SPAW2222N1
	3/4		MX-W22224EALLKW33C3	154,675 688,000	169,275 753,000	1,300	SPA224N1	HA2324M1 HE2324M1	SPAW2224-403N1 SPAW2224-404N1
	7/8		MX-W22226EALLKW33C3	181,650 808,000	201,875 898,000	1,200	SPA226N1	H2326M1 HA2326M1 HE2326M1	SPAW2226N1 SPAW2226-407N1 SPAW2226-408N1
	1		MX-W22228EALLKW33C3	205,025 912,000	227,050 1,010,000	1,100	SPA228N1	H2328M1 HA2328M1 HE2328M1	SPAW2228N1 SPAW2228-415N1 SPAW2228-500N1
	1		MX-W22232EALLKW33C3	274,275 1,220,000	312,475 1,390,000	1,000	SPA232N1	H2332M1 HA2332M1 HE2332M1	SPAW2232N1 SPAW2232-507N1 SPAW2232-508N1

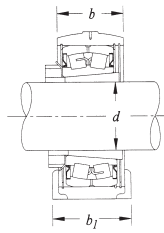
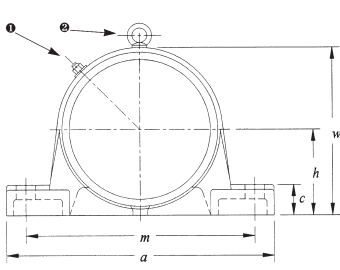

SPW22...

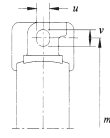

2 Bolt Base

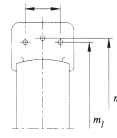

Solid Base

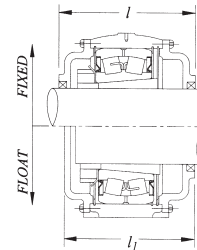

C(M)-SPW22...

Units	Shaft Dia.
Metric	50 - 140 mm
Standard	1 <sup>15</sup> / <sub>16</sub> - 5 <sup>1</sup> / <sub>2</sub> in

SEALED SPHERICAL PILLOW BLOCKS – METRIC SERIES

Shaft Dia. d	Part Number	Nominal Dimensions												
		h	a	b	b <sub>1</sub>	c	m	m <sub>1</sub>	n	w	l	l <sub>1</sub>	u	v
50	SPW2211N1													
1 <sup>15</sup> / <sub>16</sub>	SPW2211-115N1	70	255	62	70	28	210	200	40	136	120	114	18	23
2	SPW2211-200N1													
60	SPW2213N1													
2 <sup>3</sup> / <sub>16</sub>	SPW2213-203N1	80	275	70	80	30	230	220	48	157	138	126	18	23
2 <sup>1</sup> / <sub>4</sub>	SPW2213-204N1													
2 <sup>3</sup> / <sub>8</sub>	SPW2213-206N1													
65	SPW2215N1													
2 <sup>7</sup> / <sub>16</sub>	SPW2215-207N1	80	280	72	80	30	230	220	48	163	132	123	18	23
2 <sup>1</sup> / <sub>2</sub>	SPW2215-208N1													
75	SPW2217N1													
2 <sup>15</sup> / <sub>16</sub>	SPW2217-215N1	95	320	80	90	32	260	252	52	192	156	146	22	27
3	SPW2217-300N1													
90	SPW2220N1													
3 <sup>7</sup> / <sub>16</sub>	SPW2220-307N1	112	380	95	110	40	320	300	66	226	185	175	26	32
3 <sup>1</sup> / <sub>2</sub>	SPW2220-308N1													
100	SPW2222N1													
3 <sup>15</sup> / <sub>16</sub>	SPW2222-315N1	125	410	100	120	45	350	320	74	252	198	185	26	32
4	SPW2222-400N1													
110	SPW2224N1													
4 <sup>3</sup> / <sub>16</sub>	SPW2224-403N1	140	410	105	120	45	350	330	74	274	203	190	26	32
4 <sup>1</sup> / <sub>4</sub>	SPW2224-404N1													
115	SPW2226N1													
4 <sup>7</sup> / <sub>16</sub>	SPW2226-407N1	150	445	115	130	50	380	370	80	293	219	206	28	36
4 <sup>1</sup> / <sub>2</sub>	SPW2226-408N1													
125	SPW2228N1													
4 <sup>15</sup> / <sub>16</sub>	SPW2228-415N1	150	500	120	150	50	420	400	80	305	232	219	33	42
5	SPW2228-500N1													
140	SPW2232N1													
5 <sup>7</sup> / <sub>16</sub>	SPW2232-507N1	170	550	135	160	60	470	450	90	340	260	247	33	42
5 <sup>1</sup> / <sub>2</sub>	SPW2232-508N1													



**How to Order**

Example: When you order one SPW2220N1, you will receive an assembly consisting of one SP220N1 Pillow Block Housing, one MX-W2220EALLKW33C3 Bearing, and one H2320XM1 Adapter.

To order a solid base housing, add suffix F to the part number (example: SPW2220FN1).

When C-SPW2220N1 or CM-SPW2220N1 are specified, external covers will be supplied with the unit.

Example: "C" prefix – 2 open end covers

"CM" prefix – 1 open end cover, 1 closed end cover

- Notes: – Open end cover service seals for which dimensions are shown are standard.  
 For dimensions and availability of non-standard taconite service seals, consult NTN Engineering.  
 – All units are supplied in float arrangement and may be converted to fixed by relocation of a snap ring.  
 – All bearing inserts are supplied pre-lubricated with multi-purpose industrial bearing grease.  
 – Solid base housings may be drilled for 2 or 4 bolt arrangement.

Grease fittings are provided with all units.

An eye bolt is provided on housings SP228N1 and SP232N1.

**SEALED SPHERICAL PILLOW BLOCKS – METRIC SERIES (continued)**

	Set Bolts		Insert Number	Basic Load Rating (lbs/N)		Limiting Speed (rpm)	Housing Number	Adapter	Part Number
	2 req'd	4 req'd		Dynamic C	Static CO	nmax			
M16	M12	MX-W22211EALLKW33C3	34,850 155,000	33,270 148,000	2,700	SP211N1	H2311XM1 HA2311M1 HE2311XYM1	SPW2211N1 SPW2211-115N1 SPW2211-200N1	
M16	M12	MX-W22213EALLKW33C3	50,800 226,000	50,350 224,000	2,300	SP213N1	H2313XM1 HA2313M1 HE2313XM1 HS2313XM1	SPW2213N1 SPW2213-203N1 SPW2213-204N1 SPW2213-206N1	
M16	M12	MX-W22215EALLKW33C3	54,850 244,000	55,975 249,000	2,000	SP215N1	H2315XM1 HA2315M1 HE2315XM1	SPW2215N1 SPW2215-207N1 SPW2215-208N1	
M20	M16	MX-W22217EALLKW33C3	72,825 324,000	74,200 330,000	1,800	SP217N1	H2317XM1 HA2317XM1 HE2317XM1	SPW2217N1 SPW2217-215N1 SPW2217-300N1	
M24	M16	MX-W22220EALLKW33C3	106,100 472,000	111,275 495,000	1,500	SP220N1	H2320XM1 HA2320M1 HE2320XM1	SPW2220N1 SPW2220-307N1 SPW2220-308N1	
M24	M16	MX-W22222EALLKW33C3	135,325 602,000	144,550 643,000	1,400	SP222N1	H2322XM1 HA2322M1 HE2322XM1	SPW2222N1 SPW2222-315N1 SPW2222-400N1	
M24	M16	MX-W22224EALLKW33C3	154,675 688,000	169,275 753,000	1,300	SP224N1	H2324XM1 HA2324M1 HE2324M1	SPW2224N1 SPW2224-403N1 SPW2224-404N1	
M24	M20	MX-W22226EALLKW33C3	181,650 808,000	201,875 898,000	1,200	SP226N1	H2326M1 HA2326M1 HE2326M1	SPW2226N1 SPW2226-407N1 SPW2226-408N1	
M30	M24	MX-W22228EALLKW33C3	205,025 912,000	227,050 1,010,000	1,100	SP228N1	H2328M1 HA2328M1 HE2328M1	SPW2228N1 SPW2228-415N1 SPW2228-500N1	
M30	M24	MX-W22232EALLKW33C3	274,275 1,220,000	312,475 1,390,000	1,000	SP232N1	H2332M1 HA2332M1 HE2332M1	SPW2232N1 SPW2232-507N1 SPW2232-508N1	

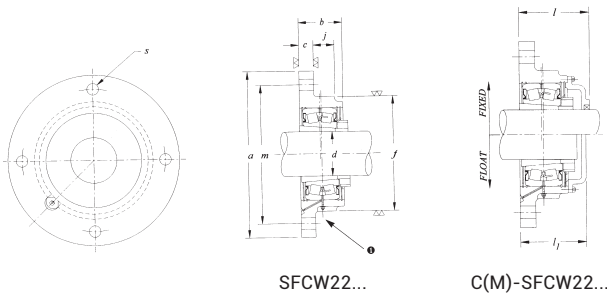

Units	Shaft Dia.
Metric	50 - 140 mm
Standard	1 <sup>15</sup> / <sub>16</sub> - 5 <sup>1</sup> / <sub>2</sub> in

SEALED SPHERICAL FLANGE BLOCK SERIES

Shaft Dia. d	Part Number	Nominal Dimensions								
		a	b	c	m	f	j	l	l <sub>1</sub>	s
50	SFCW2211N1									
1 <sup>15</sup> / <sub>16</sub>	SFCW2211-115N1	200	62	19	165	130	25	91	85	14
2	SFCW2211-200N1									
60	SFCW2213N1									
2 <sup>3</sup> / <sub>16</sub>	SFCW2213-203N1	240	70	24	190	155	25	104	92	14
2 <sup>1</sup> / <sub>4</sub>	SFCW2213-204N1									
2 <sup>3</sup> / <sub>8</sub>	SFCW2213-206N1									
65	SFCW2215N1									
2 <sup>7</sup> / <sub>16</sub>	SFCW2215-207N1	255	72	24	215	170	32	102	93	17
2 <sup>1</sup> / <sub>2</sub>	SFCW2215-208N1									
75	SFCW2217N1									
2 <sup>15</sup> / <sub>16</sub>	SFCW2217-215N1	270	80	27	240	190	32	118	108	17
3	SFCW2217-300N1									
90	SFCW2220N1									
3 <sup>7</sup> / <sub>16</sub>	SFCW2220-307N1	330	95	29	280	230	38	140	130	20
3 <sup>1</sup> / <sub>2</sub>	SFCW2220-308N1									
100	SFCW2222N1									
3 <sup>15</sup> / <sub>16</sub>	SFCW2222-315N1	365	100	32	310	255	42	149	136	20
4	SFCW2222-400N1									
110	SFCW2224N1									
4 <sup>3</sup> / <sub>16</sub>	SFCW2224-403N1	400	105	32	330	275	42	154	141	23
4 <sup>1</sup> / <sub>4</sub>	SFCW2224-404N1									
115	SFCW2226N1									
4 <sup>7</sup> / <sub>16</sub>	SFCW2226-407N1	416	115	32	355	290	42	167	154	23
4 <sup>1</sup> / <sub>2</sub>	SFCW2226-408N1									
125	SFCW2228N1									
4 <sup>15</sup> / <sub>16</sub>	SFCW2228-415N1	450	120	45	385	310	56	174	163	35
5	SFCW2228-500N1									
140	SFCW2232N1									
5 <sup>7</sup> / <sub>16</sub>	SFCW2232-507N1	520	135	45	435	360	65	195	185	35
5 <sup>1</sup> / <sub>2</sub>	SFCW2232-508N1									

How to Order

Example: When you order one SFCW2220N1, you will receive an assembly consisting of one SFC220N1 Flange Block Housing, one MX-W2220EALLKW33C3 Bearing, and one H2320XM1 Adapter.

When C-SFCW2220N1 or CM-SFCW2220N1 are specified, external covers will be supplied with the unit.

Example: "C" prefix – 1 open end cover

"CM" prefix – 1 closed end cover

Notes: – Open end cover service seals for which dimensions are shown are standard.

For dimensions and availability of non-standard taconite service seals, consult NTN Engineering.

– All units are supplied in float arrangement and may be converted to fixed by relocation of a snap ring.

– All bearing inserts are supplied pre-lubricated with multi-purpose industrial bearing grease.

Grease fittings are provided with all units.

SEALED SPHERICAL FLANGE BLOCK SERIES (continued)

Insert Number	Basic Load Rating (lbs/N)		Limiting Speed (rpm)	Housing Number	Adapter	Part Number
	Dynamic C	Static CO	nmax			
MX-W22211EALLKW33C3	34,850 155,000	33,270 148,000	2,700	SFC211N1	H2311XM1	SFCW2211N1
					HA2311M1	SFCW2211-115N1
					HE2311XM1	SFCW2211-200N1
MX-W22213EALLKW33C3	50,800 226,000	50,350 224,000	2,300	SFC213N1	H2313XM1	SFCW2213N1
					HA2313M1	SFCW2213-203N1
					HE2313XM1	SFCW2213-204N1
					HS2313XM1	SFCW2213-206N1
MX-W22215EALLKW33C3	54,850 244,000	55,975 249,000	2,000	SFC215N1	H2315XM1	SFCW2215N1
					HA2315M1	SFCW2215-207N1
					HE2315XM1	SFCW2215-208N1
MX-W22217EALLKW33C3	72,825 324,000	74,200 330,000	1,800	SFC217N1	H2317XM1	SFCW2217N1
					HA2317XM1	SFCW2217-215N1
					HE2317XM1	SFCW2217-300N1
MX-W22220EALLKW33C3	106,100 472,000	111,275 495,000	1,500	SFC220N1	H2320XM1	SFCW2220N1
					HA2320M1	SFCW2220-307N1
					HE2320XM1	SFCW2220-308N1
MX-W22222EALLKW33C3	135,325 602,000	144,550 643,000	1,400	SFC222N1	H2322XM1	SFCW2222N1
					HA2322M1	SFCW2222-315N1
					HE2322XM1	SFCW2222-400N1
MX-W22224EALLKW33C3	154,675 688,000	169,275 753,000	1,300	SFC224N1	H2324XM1	SFCW2224N1
					HA2324M1	SFCW2224-403N1
					HE2324M1	SFCW2224-404N1
MX-W22226EALLKW33C3	181,650 808,000	201,875 898,000	1,200	SFC226N1	H2326M1	SFCW2226N1
					HA2326M1	SFCW2226-407N1
					HE2326M1	SFCW2226-408N1
MX-W22228EALLKW33C3	205,025 912,000	227,050 1,010,000	1,100	SFC228N1	H2328M1	SFCW2228N1
					HA2328M1	SFCW2228-415N1
					HE2328M1	SFCW2228-500N1
MX-W22232EALLKW33C3	274,275 1,220,000	312,475 1,390,000	1,000	SFC232N1	H2332M1	SFCW2232N1
					HA2332M1	SFCW2232-507N1
					HE2332M1	SFCW2232-508N1

# SPAW/SPW/SFCW Installation Instructions

The following is the recommended procedure for mounting the SPW, SPAW and SFCW 2200 series heavy duty bearing units.

1. Adjust the position of the sleeve so that the tapered part comes to about the center of the bearing. The sleeve should be positioned so that the nut is easily accessible (see Fig. 1).
2. The SPW/SPAW/SFCW bearing unit can be adapted to either the fixed or floating configuration. Units are supplied in the floating configuration unless otherwise specified upon ordering.

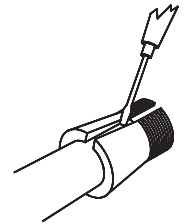

Figure 1

**FIXED CONFIGURATION:** Using appropriate size snap ring pliers, position the snap ring in the innermost groove of the housing.

**FLOATING CONFIGURATION:** Using appropriate size snap ring pliers, position the snap ring in the outermost groove of the housing.

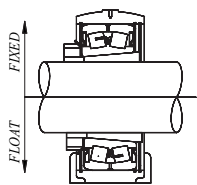

Figure 2

3. Install the unit on the shaft by sliding the bearing onto the adapter sleeve. Adjust the entire assembly as needed until the final bearing location is achieved. For floating configuration, ensure the bearing is centered in the housing before performing final adjustments (as in Figure 2).

*Use eye protection and follow appropriate safety practices at all times.*

4. It is very important that positive contact is established between the shaft, adapter sleeve and the bearing. Tap the wide end of the adapter sleeve lightly over its entire circumference. A cylindrical sleeve may be placed against the inner ring of the bearing to ensure it remains centered for floating configuration (see Figure 3). Install the lock washer and hand tighten the locknut. Verify that positive contact is made by tapping the groove on the back side of the adapter sleeve. If the sleeve rotates, positive contact has not been established and step 4 will need to be repeated.

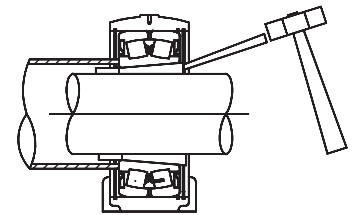

Figure 3

*Relieving the weight of the shaft on the bearing will help achieve positive contact.*

5. Tighten the locknut according to the following table. A hook spanner or a hammer and punch are commonly used.

GUIDELINES FOR MOUNTING*								
Shaft Diameter Range			Bearing Number	Axial Displacement		Recommended Locknut Rotation	Hydraulic Pressure	
over Inch	incl. Inch	Metric		min. Inch	max. Inch		min. lbf/in <sup>2</sup>	max. lbf/in <sup>2</sup>
	1 15/16	50mm	MX-W22211EALLKW33C3	0.018	0.024	90°	1700	2250
1 15/16	2		MX-W22211EALLKW33C3	0.018	0.024	130° **	1700	2250
2	2 3/8	60mm	MX-W22213EALLKW33C3	0.018	0.024	90°	1750	2350
2 3/8	2 1/2	65mm	MX-W22215EALLKW33C3	0.024	0.030	120°	1800	2250
2 1/2	3	75mm	MX-W22217EALLKW33C3	0.028	0.035	150°	2050	2700
3	3 1/2	90mm	MX-W22220EALLKW33C3	0.028	0.035	150°	2250	3000
3 1/2	4	100mm	MX-W22222EALLKW33C3	0.030	0.043	180°	2650	3700
4	4 1/4	110mm	MX-W22224EALLKW33C3	0.030	0.043	180°	2750	3850
4 1/4	4 1/2	115mm	MX-W22226EALLKW33C3	0.043	0.055	210°	3250	4500
4 1/2	5	125mm	MX-W22228EALLKW33C3	0.043	0.055	210°	3300	4550
5	5 1/2	140mm	MX-W22232EALLKW33C3	0.047	0.063	150° ***	3950	5250

\* Values apply to solid shafts and normal loads after positive contact is achieved. For hollow shafts, heavy loads (Pr>0.12Cr), or other special circumstances, please consult NTN Engineering.

\*\* Value reflects a decrease in adapter sleeve thread pitch (2 inch shaft only).

\*\*\* Value reflects an increase in adapter sleeve thread pitch.

6. Bend one of the tabs on the circumference of the lock washer into the nearest notch on the rim of the locknut. If no tabs line up, tighten the locknut slightly. The locknut should not be loosened in order to align the tab with a notch.
7. Reposition the housing and mount the unit securely to the machine.

**Excessive misalignment can cause the bearing seals to become unsealed. Seals can only be re-installed if unit has not been run for any length of time, if no contamination of the bearing has occurred, and if even pressure can be applied around the periphery of the seal to prevent bending.**

**Bearings come pre-lubricated with multi-purpose industrial bearing grease and require no lubrication upon initial installation.**

**For extremely contaminated environments, external covers are available.**

### REMOVAL INSTRUCTIONS

1. To remove the unit from the shaft, raise the bent lock washer tab, loosen the locknut two or three turns, then tap the nut over its entire circumference with a hammer and punch. Ensure sufficient threads remain engaged as to not damage them. Continue tapping until the adapter sleeve can be moved.
2. To remove the bearing insert from the housing, remove one of the snap rings and slide the bearing out.

*Appropriate eye protection should be worn when handling snap rings.*

## SPAW/SPW/SFCW Technical Information

SPAW/SPW PILLOW BLOCK HOUSING ALLOWABLE LOADS					
Housing	Allowable Loads (lbs)*				
	P60	P90	P120	P150	P180
SP211N1	12,500	7,500	5,500	5,000	6,000
SP211FN1	27,500	16,500	12,000	11,000	14,000
SP213N1	18,500	11,500	8,500	7,500	9,500
SP213FN1	34,500	21,000	15,500	14,000	17,500
SP215N1	21,500	13,000	10,000	9,000	11,000
SP215FN1	40,000	25,000	18,000	16,000	20,000
SP217N1	28,500	17,000	12,500	11,500	14,500
SP217FN1	47,000	28,000	21,000	18,500	23,000
SP220N1	38,500	23,000	17,000	15,500	19,500
SP220FN1	52,500	31,500	27,000	21,000	26,500
SP222N1	47,500	28,500	21,000	18,500	23,500
SP222FN1	61,500	37,500	27,500	25,000	31,000
SP224N1	71,500	45,000	24,500	22,000	24,500
SP224FN1	93,500	58,500	35,500	31,000	35,500
SP226N1	77,000	48,500	26,500	24,000	26,500
SP226FN1	104,500	66,000	37,500	33,000	37,500
SP228N1	82,500	52,000	27,500	25,500	27,500
SP228FN1	119,000	75,000	40,000	36,500	40,000
SP232N1	100,500	63,000	34,000	31,000	34,000
SP232FN1	143,500	90,500	48,500	44,000	48,500

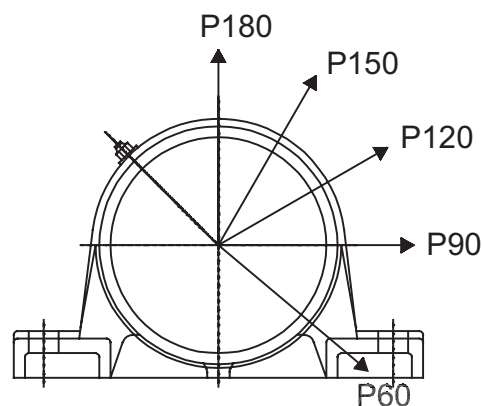

**Notes:**

- Allowable thrust loads for complete assemblies mounted on straight shafts depend on the fit between adapter sleeve and shaft.
- Please consult NTN Engineering.

\*Values include a safety factor of 2. For more severe conditions, higher safety factors must be applied.

# SPAW/SPW/SFCW Engineering

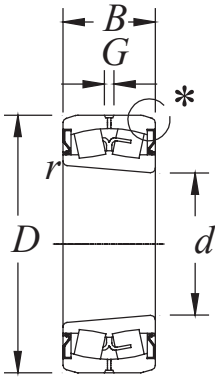

**MX-W222K**  
Taper 1:12

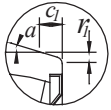

\* Detail:

SEALED SPHERICAL ROLLER BEARING INSERTS								
Bearing Number	Dimensions (Inch/mm)				Basic Load Rating (lbs/N)		Limiting Speed (rpm)	Weight (lbs)
	Bore	O.D.	Width	Oil Groove Width	Dynamic C	Static Co	nmax	
MX-W22211EALLKW33C3	2.1654 55	3.9370 100	1.5748 40	0.2362 6	34,850 155,000	33,270 148,000	2,700	2.34
MX-W22213EALLKW33C3	2.5591 65	4.7244 120	1.8307 46.5	0.3149 8	50,800 226,000	50,350 224,000	2,300	4.12
MX-W22215EALLKW33C3	2.9528 75	5.1181 130	1.8307 46.5	0.2756 7	54,850 244,000	55,975 249,000	2,000	4.54
MX-W22217EALLKW33C3	3.3465 85	5.9055 150	2.0276 51.5	0.3149 8	72,825 324,000	74,200 330,000	1,800	6.79
MX-W22220EALLKW33C3	3.937 100	7.0866 180	2.5394 64.5	0.4331 11	106,100 472,000	111,275 495,000	1,500	12.83
MX-W22222EALLKW33C3	4.3307 110	7.8740 200	2.7953 71	0.4724 12	135,325 602,000	144,550 643,000	1,400	17.97
MX-W22224EALLKW33C3	4.7244 120	8.4646 215	2.9921 76	0.4724 12	154,675 688,000	169,275 753,000	1,300	22.27
MX-W22226EALLKW33C3	5.1181 130	9.0551 230	3.3071 84	0.5118 13	181,650 808,000	201,875 898,000	1,200	27.56
MX-W22228EALLKW33C3	5.5118 140	9.8425 250	3.4627 88	0.5512 14	205,025 912,000	227,050 1,010,000	1,100	34.61
MX-W22232EALLKW33C3	6.2992 160	11.4173 290	4.0945 104	0.6693 17	274,275 1,220,000	312,475 1,390,000	1,000	56.00

**Notes:**

- All bearing inserts are supplied pre-lubricated with multi-purpose industrial bearing grease .
- Outer ring lubrication holes and oil groove provided as standard.
- Limiting speeds listed may not apply under conditions of greater than normal load and/or temperature.

\*For outside diameter chamfer dimensions, please contact NTN Engineering.



# SPAW/SPW/SFCW Engineering

Recommended Shaft Tolerances			
Bore Size		Shaft Tolerance	
Inch	Metric	Inch	Metric
1 <sup>15</sup> / <sub>16</sub> 2	50mm	nominal to -.0029 inch	nominal to -74 micron
2 <sup>3</sup> / <sub>16</sub> 2 <sup>1</sup> / <sub>4</sub> 2 <sup>3</sup> / <sub>8</sub>	60mm		
2 <sup>7</sup> / <sub>16</sub> 2 <sup>1</sup> / <sub>2</sub>	65mm		
2 <sup>15</sup> / <sub>16</sub> 3	75mm	nominal to -.003 inch	nominal to -87 micron
3 <sup>7</sup> / <sub>16</sub> 3 <sup>1</sup> / <sub>2</sub>	90mm		
3 <sup>15</sup> / <sub>16</sub> 4	100mm		
4 <sup>3</sup> / <sub>16</sub> 4 <sup>1</sup> / <sub>4</sub>	110mm	nominal to -.0039 inch	nominal to -100 micron
4 <sup>7</sup> / <sub>16</sub> 4 <sup>1</sup> / <sub>2</sub>	115mm		
4 <sup>15</sup> / <sub>16</sub> 5	125mm	nominal to -.0039 inch	nominal to -100 micron
5 <sup>7</sup> / <sub>16</sub> 5 <sup>1</sup> / <sub>2</sub>	140mm		

SPAW/SPW/SFCW MX-W Relubrication Schedule			
MX-W Insert	Relubrication Interval Under Normal Environmental Conditions <sup>1</sup> (hours)	Relubrication Interval Under Contaminated Environmental Conditions (hours)	Approximate Relubrication Grease Quantity <sup>2</sup> (grams)
MX-W22211EALLKW33C3	2,100	1,050	10
MX-W22213EALLKW33C3	1,800	900	15
MX-W22215EALLKW33C3	1,500	750	18
MX-W22217EALLKW33C3	1,300	650	28
MX-W22220EALLKW33C3	1,100	550	50
MX-W22222EALLKW33C3	1,000	500	70
MX-W22224EALLKW33C3	900	450	85
MX-W22226EALLKW33C3	800	400	100
MX-W22228EALLKW33C3	700	350	130
MX-W22232EALLKW33C3	600	300	225

<sup>1</sup> Re-lubrication interval values were derived from NTN cat. 2202-XII/E, Fig.11.2. Values apply to the basic bearing part number independent of actual shaft size (eg. SPW2215-207) and with the following assumptions:

- Equivalent radial load is less than 9% of Cr
- Axial load is less than 30% of radial load
- Speed is 1 000 rpm

<sup>2</sup> Re-lubrication quantity values based on grease with specific gravity 0.9. Value represents 50% of initial factory fill value.

Notes: Actual operating conditions will change the re-lubrication interval and the above is only given as a general guide. Please consult NTN Engineering for further review. To avoid over-greasing, it is recommended that the unit is not lubricated while stationary.

# SPAW/SPW/SFCW Components

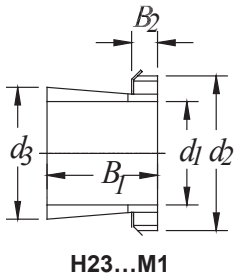

ADAPTERS FOR BEARINGS SERIES MX-W222K										
Complete Adapter No.	Adapter Sleeve No.	Lock-Nut No.	Lock-Washer No.	Dimensions					Thread	Weight (lbs)
				Shaft (Bore) Dia.						
				$d_1$	$d_{2,max}$	$d_{3,max}$	$B_1$	$B_2$		
HA2311M1	AA2311M1	AN11M1	AW11	1 <sup>15</sup> / <sub>16</sub>	2.953	2.322	2.323	0.472	M55X2	1.0
H2311XM1	A2311XM1	AN11M1	AW11X	50mm	2.953	2.322	2.323	0.472	M55X2	0.9
HE2311XYM1	AE2311XYM1	AN11YM1	AW11X	2	2.953	2.322	2.323	0.472	M55X1.5	0.9
HA2313M1	AA2313M1	AN13M1	AW13	2 <sup>3</sup> / <sub>16</sub>	3.346	2.729	2.559	0.551	M65X2	1.7
HE2313XM1	AE2313XM1	AN13M1	AW13X	2 <sup>1</sup> / <sub>4</sub>	3.346	2.729	2.559	0.551	M65X2	1.5
H2313XM1	A2313XM1	AN13M1	AW13X	60mm	3.346	2.729	2.559	0.551	M65X2	1.2
HS2313XM1	AS2313XM1	AN13M1	AW13X	2 <sup>3</sup> / <sub>8</sub>	3.346	2.729	2.559	0.551	M65X2	1.2
HA2315M1	AA2315M1	AN15M1	AW15	2 <sup>7</sup> / <sub>16</sub>	3.858	3.145	2.874	0.591	M75X2	2.3
HE2315XM1	AE2315XM1	AN15M1	AW15X	2 <sup>1</sup> / <sub>2</sub>	3.858	3.145	2.874	0.591	M75X2	2.5
H2315XM1	A2315XM1	AN15M1	AW15X	65mm	3.858	3.145	2.874	0.591	M75X2	2.3
HA2317XM1	AA2317XM1	AN17M1	AW17X	2 <sup>15</sup> / <sub>16</sub>	4.331	3.559	3.228	0.709	M85X2	3.2
H2317XM1	A2317XM1	AN17M1	AW17X	75mm	4.331	3.559	3.228	0.709	M85X2	3.2
HE2317XM1	AE2317XM1	AN17M1	AW17X	3	4.331	3.559	3.228	0.709	M85X2	3.0
HA2320M1	AA2320M1	AN20M1	AW20	3 <sup>7</sup> / <sub>16</sub>	5.118	4.192	3.819	0.787	M100X2	5.3
HE2320XM1	AE2320XM1	AN20M1	AW20X	3 <sup>1</sup> / <sub>2</sub>	5.118	4.192	3.819	0.787	M100X2	5.0
H2320XM1	A2320XM1	AN20M1	AW20X	90mm	5.118	4.192	3.819	0.787	M100X2	4.7
H2322XM1	A2322XM1	AN22M1	AW22X	100mm	5.709	4.609	4.134	0.827	M110X2	6.0
HA2322XM1	AA2322XM1	AN22M1	AW22X	3 <sup>15</sup> / <sub>16</sub>	5.709	4.609	4.134	0.827	M110X2	6.0
HE2322XM1	AE2322XM1	AN22M1	AW22X	4	5.709	4.609	4.134	0.827	M110X2	5.6
HA2324M1	AA2324M1	AN24M1	AW24	4 <sup>3</sup> / <sub>16</sub>	6.102	5.022	4.409	0.866	M120X2	8.2
HE2324M1	AE2324M1	AN24M1	AW24	4 <sup>1</sup> / <sub>4</sub>	6.102	5.022	4.409	0.866	M120X2	7.7
H2324XM1	A2324XM1	AN24M1	AW24X	110mm	6.102	5.022	4.409	0.866	M120X2	7.0
HA2326M1	AA2326M1	AN26M1	AW26	4 <sup>7</sup> / <sub>16</sub>	6.496	5.443	4.764	0.906	M130X2	10.1
HE2326M1	AE2326M1	AN26M1	AW26	4 <sup>1</sup> / <sub>2</sub>	6.496	5.443	4.764	0.906	M130X2	10.1
H2326M1	A2326M1	AN26M1	AW26	115mm	6.496	5.443	4.764	0.906	M130X2	10.1
H2328M1	A2328M1	AN28M1	AW28	125mm	7.087	5.866	5.157	0.945	M140X2	12.2
HA2328M1	AA2328M1	AN28M1	AW28	4 <sup>15</sup> / <sub>16</sub>	7.087	5.866	5.157	0.945	M140X2	12.1
HE2328M1	AE2328M1	AN28M1	AW28	5	7.087	5.866	5.157	0.945	M140X2	11.3
HA2332M1	AA2332M1	AN32M1	AW32	5 <sup>7</sup> / <sub>16</sub>	8.268	6.693	5.787	1.102	M160X3	21.2
HE2332M1	AE2332M1	AN32M1	AW32	5 <sup>1</sup> / <sub>2</sub>	8.268	6.693	5.787	1.102	M160X3	20.3
H2332M1	A2332M1	AN32M1	AW32	140mm	8.268	6.693	5.787	1.102	M160X3	20.2

**Notes:**

- The adapter number denotes the complete assembly consisting of adapter sleeve, locknut and lock washer.
- Suffix X denotes the narrow slot type of adapter sleeve.
- The straight inner tab type of lock washer (also denoted by X) should be used with this sleeve.
- Suffix Y denotes a non-standard thread.

# SPAW/SPW/SFCW Accessories

Over 55% of premature bearing failures are lubrication related. The most common causes are missed lubrication intervals, applying the wrong type or amount of lubricant, applying lubricant at incorrect intervals based on recommendations, excessive pressure resulting in seal failure, and/or contamination ingress. All of these problems are preventable. NTN automatic lubricators provide a constant and controlled supply of quality grease, 24 hours a day, 7 days a week.

## READY: Gas-powered



All-in-one gas-powered lubricator; no activator required.

## SMART: Electro-chemical

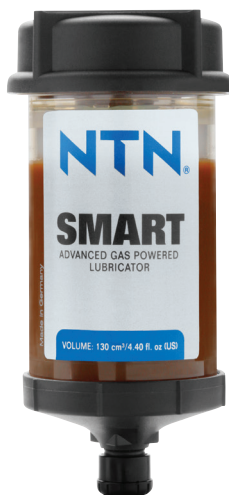

Advanced gas-powered unit; not affected by temperature changes.

## DRIVE: Electro-mechanical



Motorized unit; provides precise lubrication amount; 360 degree lights allow for instant status updates.

Avoid damaging your bearing units during installation by using an NTN spanner wrench for proper installation. Using a spanner wrench helps minimize the risk of damaging the shaft, nut or bearing during installation.

Spanner Wrenches		
Bore Size		Spanner Wrench Part Number
Inch	Metric	
1 15/16 - 2	50mm	TLS-HKSPANNER50-80
2 3/16 - 3	60-75mm	TLS-HKSPANNER80-120
3 7/16 - 5	90-125mm	TLS-HKSPANNER120-180
5 7/16 - 5 1/2	140mm	NOT AVAILABLE







Since 1918, NTN has been a trusted OE manufacturer of high-performing bearing products that increase companies' productivity and efficiency.

- NTN has been the world's broad-line bearing manufacturer for nearly 100 years.
- NTN has the largest bearing manufacturing footprint in the United States.
- NTN is the largest supplier of American-made products to the construction and mining industries.
- NTN is a major supplier to over two-thirds of the world's "Fortune 500" manufacturing companies.
- More cars worldwide ride on NTN bearings and drivetrains than any other manufacturer's product.

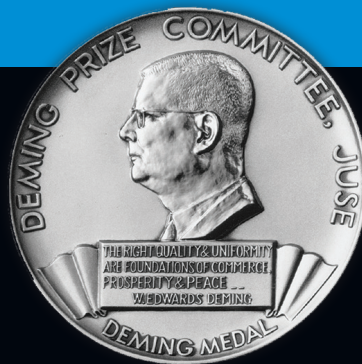

◀ NTN was the first bearing manufacturer to be awarded the prestigious Deming Prize for recognition of its quality products and systems.



# Beyond Bearings

Training. Installation Support.  
Trouble-shooting. And more.

When you choose NTN, your team is equipped with all the necessary tools and resources to get the job done right. From installation to problem-solving, we'll be there with the hands-on support you need to take on your toughest challenges. This includes extra services such as:



## Technical Training Unit

On-site, mobile training unit offering specialized, hands-on instruction from NTN engineers



## Product Training School

Three days of in-depth instruction from NTN engineers at NTN headquarters  
([go.ntnamericas.com/trainingschool](http://go.ntnamericas.com/trainingschool))



## eKnowledge

WEB-BASED TRAINING PROGRAM

Six online product training modules covering different bearing types and nomenclature  
([www.ntnamericas.com/eknowledge](http://www.ntnamericas.com/eknowledge))



## NTN Bearing Finder

Customizable search tool featuring exhaustive data sets, comprehensive part interchanges and interactive CAD drawings  
([bearingfinder.ntnamericas.com](http://bearingfinder.ntnamericas.com))



Ready to get rolling? Contact us today for full details at  
1-800-323-2358 or [eng@ntnamerica.com](mailto:eng@ntnamerica.com).

# NTN<sup>®</sup>

NTN BEARING CORPORATION OF AMERICA • 1600 E. Bishop Court • Mount Prospect, IL 60056-7604, U.S.A.

Tel: 847-298-7500 • Fax: 847-294-1205 • [www.ntnamericas.com](http://www.ntnamericas.com)