



# ISOSTATIC™

LEADERS IN BRONZE and TU BEARINGS

Powdered Metal Bronze - SAE 841 - Inch & Metric

---

Cast Bronze - SAE 660

---

TU-Steel Backed PTFE Lined - Inch & Metric

---

Powdered Metal Iron - SAE 863 - Inch

---

Special Order Products

---



Telephone: 800 621-5500

[www.isostatic.com](http://www.isostatic.com)

## INDEX

Page Nos.

**Oilube Design Parameters for Bearings**

|                                                        |   |
|--------------------------------------------------------|---|
| Shaft Selection                                        | 3 |
| Bearing Wall Thickness                                 | 3 |
| Bearing Length                                         | 3 |
| Loads, Speeds and PV                                   | 3 |
| Tolerances                                             | 4 |
| Calculating Bearing Dimensions and Installed Clearance | 5 |
| Stock Size Usage                                       | 6 |
| Bearing Clearance                                      | 6 |
| Press Fit values                                       | 6 |
| I.D. Close-In                                          | 6 |
| Lubrication                                            | 7 |
| Custom Made Bearings                                   | 7 |
| Material Specifications                                | 7 |

**Oilube Powdered Metal Bearings (SAE841)**

|                                               |       |
|-----------------------------------------------|-------|
| Sleeve Bearings                               | 8-24  |
| Flange Bearings                               | 25-29 |
| Thrust Bearings (Washers)                     | 30-32 |
| Bar Stock                                     | 33    |
| Circular Bearing Plates (Discs)               | 34    |
| Rectangular Plate Stock                       | 34    |
| Super Oilube Bar Stock - SAE863 (78-82% iron) | 34    |

**Oilube Powdered Metal Bearings (SAE841)**

|                 |       |
|-----------------|-------|
| Tolerances      | 35    |
| Sleeve Bearings | 36-38 |
| Flange Bearings | 39-40 |

**Century Cast Bronze Bearings (SAE660)**

|                                                          |       |
|----------------------------------------------------------|-------|
| Special Sizes and Alloys                                 | 41    |
| Grooving and Graphiting                                  | 41    |
| Material Specs., Tolerances, Shaft Clearances, Press Fit | 42    |
| Sleeve Bearings                                          | 43-48 |

**Century Cast Bronze Bars**

49-50

**TU Steel-Backed PTFE Lined Bearings**

|                                             |       |
|---------------------------------------------|-------|
| Design Parameters - Self-Lubricating        | 51    |
| Service Life Estimate                       | 52-53 |
| TU - Sleeve, Flange Bearings - Inch Sizes   | 54-55 |
| TU - Sleeve, Flange Bearings - Metric Sizes | 56-57 |
| TU - Thrust Washers - Inch / Metric Sizes   | 58    |

**TP Lead-Free Steel-Backed PTFE Lined Bearings**

|                                                           |    |
|-----------------------------------------------------------|----|
| TP - Sleeve, Flange, Thrust Washers - Inch / Metric Sizes | 59 |
|-----------------------------------------------------------|----|

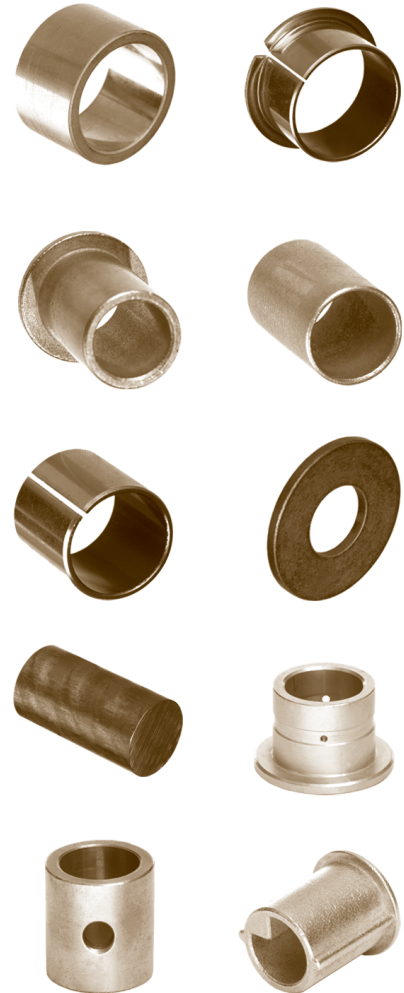
**Single Source Supply**

Our firm stocks the largest inventory of standard sizes in the U.S. This one source supply eliminates "shopping" for your part. Stock bearings are made with the highest quality powdered metals, and meet the requirements of S.A.E. specifications.

**LOCATION**

## DESIGN PARAMETERS FOR OILUBE BEARINGS

The following information will aid you in the proper selection of bearings to meet your needs. The sample problems will illustrate the design criteria which must be established in order to select the proper bearing. Should any questions arise, our staff is ready to assist you.

**Sample Problem:** Design a bearing for 180 pound load at a speed of 1100 RPM

### SHAFT SELECTION

Shaft size will be determined by the size and construction of the unit being designed. Refer to our PV Chart (page 5) in order to determine approximate criteria.

**Example:** A 1.000 shaft is chosen. The PV chart shows that a 1.000 shaft operating at 1100 RPM will carry 175 pounds per sq. inch load.

$$8\sqrt{\quad} \quad \text{or} \quad 16\sqrt{\quad}$$

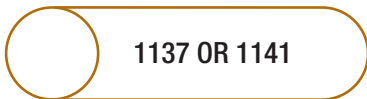

Materials Steels containing approximately 0.4% carbon are recommended, and any steels with a lower content should be avoided. The 1137-1141 series, for example, are effective grades for shaft material. In addition, drill rod and hardened and ground steels can be used.

Hard chromium plated materials are recommended when corrosion resistance is required. The performance of stainless steel materials does not equal that of straight carbon-alloy steels. If stainless steel must be used, the 300 series should be avoided. The 400 series is a good choice in stainless, and 416 stainless, heat-treated to maximum hardness, is the best.

Zinc or cadmium plating on shafts must be avoided as they are too soft and will ball up, resulting in a loss of bearing porosity, and lubrication.

**Finishes** Shaft finish is critical to long bearing life. Recommended finish is 16 RMS to 8 RMS. In some cases, a 32 RMS finish may be adequate if the application is not too precise.

### BEARING WALL THICKNESS



For bearings less than 1/4 inch ID, the minimum wall thickness is 11/32 inch. For bearings 1/4 inch ID and larger, use the following formula to determine wall thickness:

**Example:**  
 Wall thickness = .125 x Shaft dia.  
 1" shaft  
 Wall thickness = .125 x 1000  
 Wall thickness = .125

Larger bearings with extremely thin walls are more costly to produce and result in increased unit costs.

### BEARING LENGTH

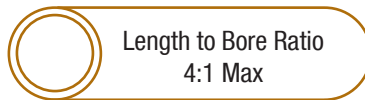

Maximum length is determined by using a ratio of length to bore, not to exceed 4:1. For diameters less than 1/4 inch, use a smaller ratio.

To determine proper bearing length, refer to the PV chart (page 5). It will give the unit load per square for a specific speed and shaft size. By dividing the unit load per square inch

into the total load to be carried by the bearing, the minimum length is found. In addition we recommend that a safety margin be used. By adding extra length, the bearing avoids operating at extreme limits.

**Example:** 180 lb. load  
 1100 RPM  
 1.000 Bearing ID  
 PV chart indicates  
 175 PSI UNIT LOAD

$180 \div 175 = 1.029$  Minimum length

|       |                  |
|-------|------------------|
| 1.029 | (Minimum Length) |
| .221  | (Safety margin)  |
| 1.250 | Suggested length |

### LOADS and SPEEDS

Load and speed limitations must be ascertained in order to insure proper bearing design. If design limits are exceeded, the bearing life will decrease and could result in premature failure. To determine the capacity of a bearing, use the following PV formula:

- (P = The load per square inch of Projected area)
- V = Shaft velocity in feet per minute
- (P =  $\frac{\text{load}}{\text{I.D.} \times \text{Length}}$ )
- V = R.P.M. x shaft diameter x .262
- (PV = (P X V)
- 1 The maximum P is 2000 P.S.I.
- 2 The maximum V is 1200 S.F.M.
- 3 The maximum PV for Oilube is 50,000

**Example:** 180 lb. load  
 1100 RPM  
 1.000 I.D. x 1.250

(P =  $\frac{180}{1.000 \times 1.250}$ )

(P = 144 WITHIN LIMIT  
 V = 1100 x 1.00 x .262  
 V = 288 SFM WITHIN LIMIT  
 (PV = 144 X 288  
 (PV = 41472 WITHIN LIMIT

## LOAD and SPEED ("PV") CHART Based on Continuous Rotation

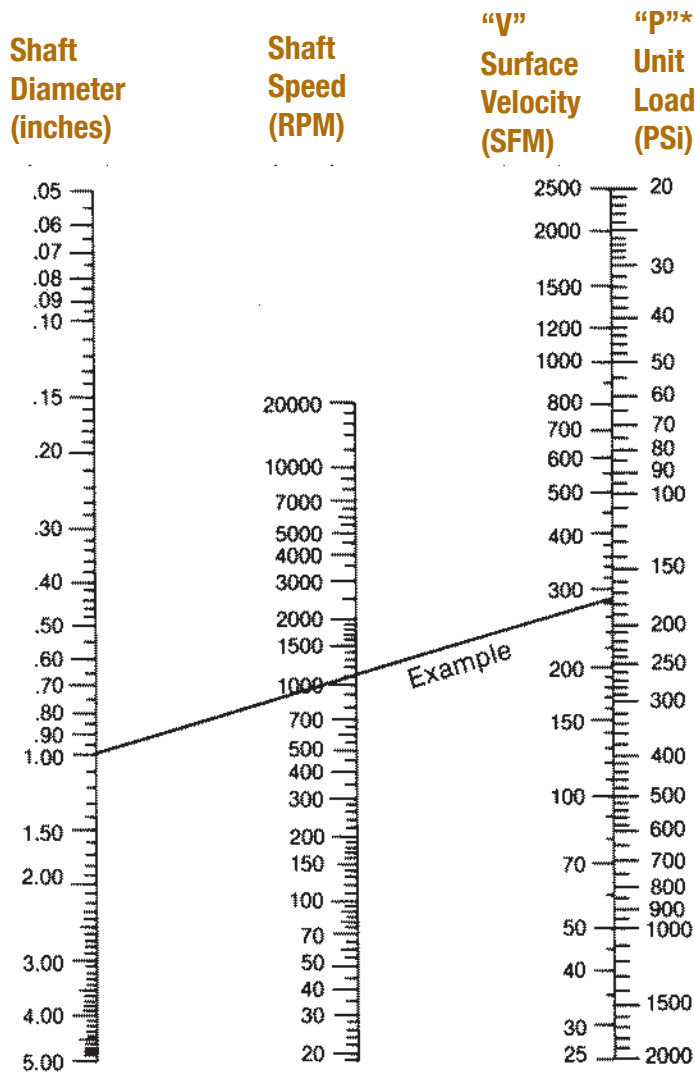

Connect two known values with a straight edge to determine the third value.

Max P = 2000  
Max V = 1200

## TOLERANCES

Based on ASTM Specifications

### SLEEVE and FLANGE BEARING

#### I.D. or D.D. Size:

|                  |        |         |
|------------------|--------|---------|
| Up to 1-1/2"     | + .000 | - .001  |
| 1-1/2" to 2-1/2" | + .000 | - .0015 |
| 2-1/2" to 3"     | + .000 | - .002  |
| 3" to 4"         | + .000 | - .003  |
| 4" to 5"         | + .000 | - .004  |
| 5" to 6"         | + .000 | - .005  |

#### Length

|              |         |
|--------------|---------|
| Up to 1-1/2" | ± .005  |
| 1-1/2" to 3" | ± .0075 |
| 3" to 5"     | ± .010  |

#### Flange Diameter

|              |        |
|--------------|--------|
| Up to 1-1/2" | ± .005 |
| 1-1/2" to 3" | ± .010 |
| 3" to 6"     | ± .025 |

#### Flange thickness:

Based on Flange O.D.

|              |        |
|--------------|--------|
| Up to 1-1/2" | ± .005 |
| 1-1/2" to 3" | ± .010 |
| 3" to 6"     | ± .015 |

#### Concentricity

|              |      |
|--------------|------|
| Up to 1-1/2" | .003 |
| 1-1/2" to 2" | .004 |
| 2" to 4"     | .006 |
| 4" to 5"     | .006 |

### THRUST BEARING (WASHERS)

#### Inside Diameter

|                  |        |
|------------------|--------|
| Up to 1-1/4"     | ± .005 |
| 1-1/4" to 2-1/2" | ± .010 |
| 2-1/2" to 4"     | ± .015 |
| 4" to 6"         | ± .020 |

#### Outside Diameter

|              |        |
|--------------|--------|
| Up to 1-1/2" | ± .010 |
| 1-1/2" to 3" | ± .015 |
| 3" to 4-1/2" | ± .020 |
| 4-1/2" to 6" | ± .025 |

Thickness ± .0025

#### Parallelism of Faces Based on D.D.

|                  |      |
|------------------|------|
| Up to 1-1/2"     | .002 |
| 1-1/2" to 3-1/2" | .003 |
| 3-1/2" to 6"     | .004 |





## EXAMPLE and WORKSHEET for CALCULATING BEARING DIMENSIONS

Fill in the blanks (. . . . .)

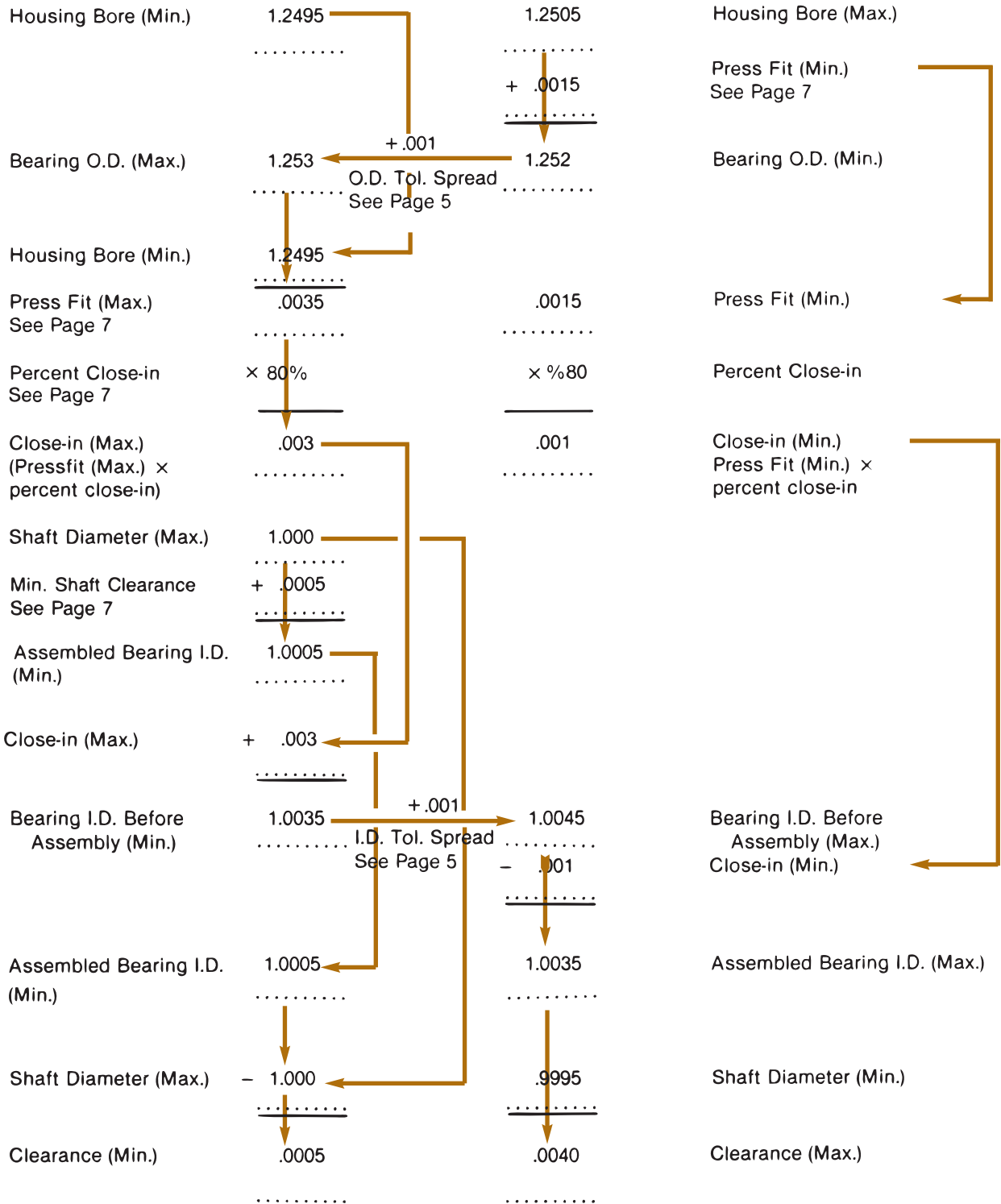

Check for Stock Size Usage (see next page)

**CHECK for STOCK SIZE USAGE**

From the calculations on the work sheet we have determined that the ideal dimensions should be

$$\frac{1.0035}{1.0045} \times \frac{1.252}{1.253} \times 1-1/4$$

The stock list shows a size of

$$\frac{1.004}{1.005} \times \frac{1.2515}{1.2525} \times 1-1/4 \text{ (AA1204-2)}$$

A check can be made to see if this standard size can be used.

|                             |          |          |
|-----------------------------|----------|----------|
| Bearing O.D.                | 1.2525   | 1.2515   |
| Housing Bore                | - 1.2495 | - 1.2505 |
| Press Fits                  | .0030    | .0010    |
| Close in factor             | × .8     | × .8     |
| Close in (to nearest .0005) | .0025    | .0010 *  |
| Bearing I.D.                | 1.0050   | 1.0040   |
| Close-in                    | - .0010  | - .0025  |
| I.D. after assembly         | 1.0040   | 1.0015   |
| Shaft diameter              | - .9995  | - 1.0000 |
| Bearing Clearance           | .0045    | .0015    |

\* Press fit deviation of .0005 is acceptable.

By using a standard size, tool costs are reduced and parts are in ready supply.

**OILUBE PRESS FIT VALVES**

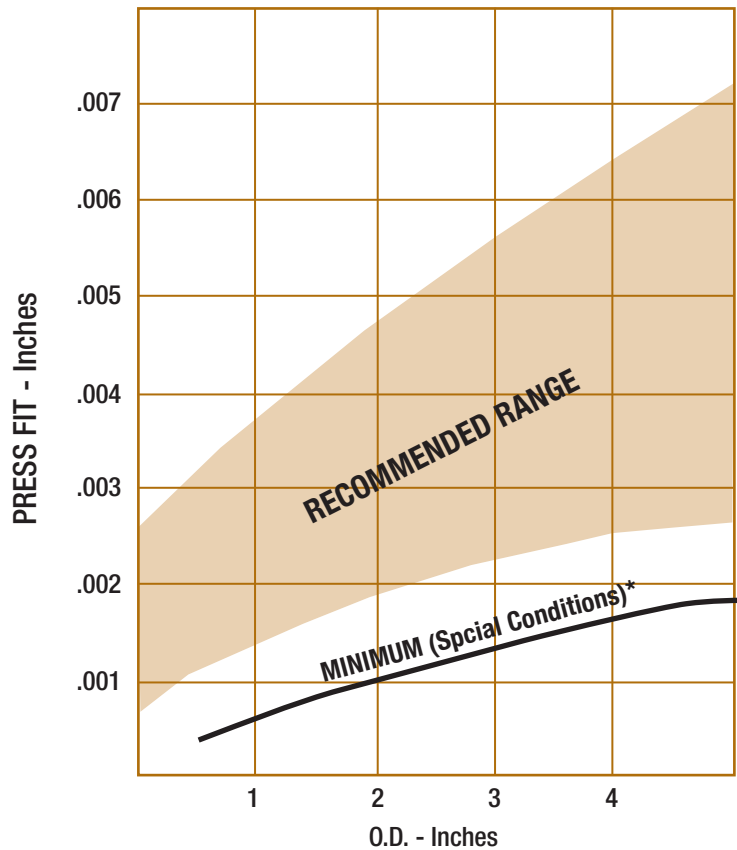

Considerable force is required to seat large bearing when press fit approaches the top of the recommended range.

- \* Less than normal press fit proves satisfactory,  
 (1) if the bearing is long and the wall is not exceptionally thin, and  
 (2) if the bearing is also carrying a moderate load exerted only in one direction.

**BEARING CLEARANCE OILUBE BEARINGS**

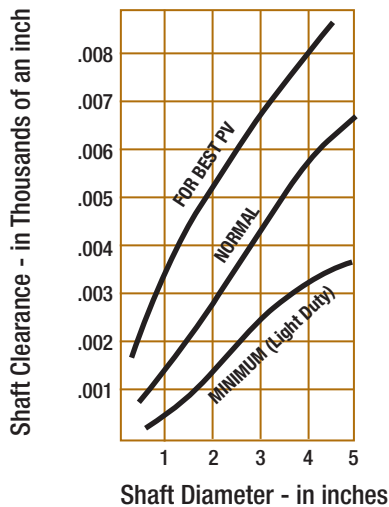

**BEARING CLEARANCE OILUBE BEARINGS**

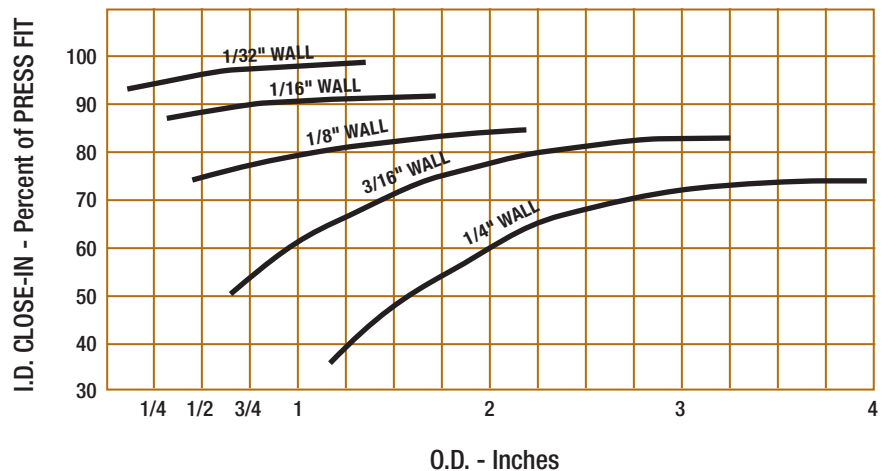

## LUBRICATION

Proper lubrication is essential for the Oilube bearing, and we use the highest quality oils available. Our standard lubricant has an effective operating range from +10°F to + 175° \*F. Applications requiring extended or unusual operating ranges must be identified so that we can select a special lubricant to do the job. This impregnation process is available for a minimal charge.

**Supplementary Lubrication** Additional lubrication can be provided thru the use of oil soaked felts, wicks, etc., or by periodic oiling. A unique advantage of the Oilube bearing is that it does not require any grooving or holes to distribute the oil across the bearing surfaces. The Oilube bearing distributes oil evenly across the bearing face due to the microscopic pores in the material.

**Storage of Bearings** Oilube bearings must be stored in non-absorbing containers. Do not store in paper or cloth containers. Do not store in cardboard boxes! The best containers are made of plastic or metal.

**De-Oiling** To remove oil from a bearing, immerse it in a solvent for 12 hours. An aromatic solvent is recommended. Chlorinated solvents should be avoided, as they can initiate corrosion within the pores of the material. After soaking in solvent, the bearings should air dry until the absorbed solvent is evaporated.

**Re-Oiling** The most efficient method of impregnation is by the vacuum

process. However, this process is typically available only to bearing manufacturers. Re-oiling can also be accomplished by immersing the bearings in oil heated to 150-175°F. This method will result in a 90% saturation of the bearing material. The graph above indicates the length of time required to achieve maximum impregnation by both methods.

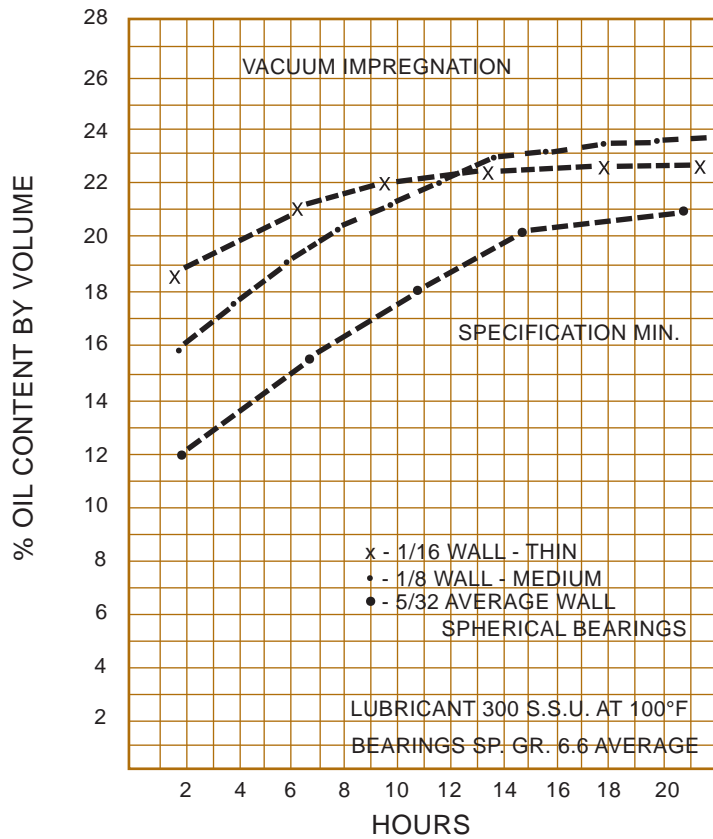

Immersion versus vacuum impregnation for bearing lubrication.

## CUSTOM MADE BEARINGS

Custom bearings can be designed and manufactured according to customer specifications, including requirements for special dimensions and/or materials. Our inventory provides for a large supply of nearly all the powdered metal mixes used in bearing manufacture. Please give us a call and tell us about your special needs.

### OILUBE MATERIAL SPECIFICATIONS

| Composition %                                                                              | Density (gm/cc) | Porosity (% by Vol.) | K Strength Constant | Tensile Strength | Elongation (in 1") | Yield Strength PSI | Comparable Specifications                                                                   | Formally                                               |
|--------------------------------------------------------------------------------------------|-----------------|----------------------|---------------------|------------------|--------------------|--------------------|---------------------------------------------------------------------------------------------|--------------------------------------------------------|
| Copper 87.5 - 90.5<br>Tin 9.5 - 10.5<br>Iron 1.0 max.<br>Carbon 1.75<br>Other Elements 0.5 | 6.4 - 6.8       | 19 min.              | 26500               | 14000            | 1                  | 11000              | ASTM B-438-70, Grade 1, Type 2<br>MPIF CT-1000-K26<br>SAE 841<br>Military - Brgs ASTM-B-438 | ----<br>CT-0010-R<br>----<br>Mil-B-5687D<br>Type 1Gr 1 |

### SUPER OILUBE MATERIAL SPECIFICATIONS

|                                                          |           |         |       |       |   |       |                                                                                |                                                           |
|----------------------------------------------------------|-----------|---------|-------|-------|---|-------|--------------------------------------------------------------------------------|-----------------------------------------------------------|
| Copper 18.0 - 22.0<br>Iron Balance<br>Other Elements 2.0 | 5.8 - 6.2 | 19 min. | 40000 | 22000 | 1 | 22000 | ASTM B-439-70, Grade 4<br>FC-2000-K30<br>SAE 863<br>Military - Brgs ASTM-B-439 | ----<br>----<br>Type 3<br>Mil-B-5687D<br>Type 2, Graded 4 |
|----------------------------------------------------------|-----------|---------|-------|-------|---|-------|--------------------------------------------------------------------------------|-----------------------------------------------------------|



| ID                         | OD    | LGTH. | ITEM NO. | PART NO.          |
|----------------------------|-------|-------|----------|-------------------|
| <b>1/8 X 3/16 NOMINAL</b>  |       |       |          |                   |
| .125                       | .190  | 5/32  | 101001   | AA-101-8          |
|                            |       | 1/4   | 101002   | AA-101-2          |
|                            |       | 3/8   | 101003   | AA-101            |
|                            |       | 1/2   | 101004   | AA-101-1          |
| .1265                      | .1895 | 1/8   | 101005   | AA-110-1          |
|                            |       | 1/4   | 101006   | AA-110-2          |
|                            |       | 5/16  | 101007   | AA-110-4          |
| .127                       | .1895 | 1/4   | 401001   | SS-46-4           |
|                            |       | 1/2   | 401002   | SS-46-8           |
| .127                       | .1905 | 1/4   | 201001   | EP020304 (P-12-2) |
|                            |       | 1/2   | 201002   | EP020308 (P-12-4) |
| <b>1/8 X 7/32 NOMINAL</b>  |       |       |          |                   |
| .127                       | .222  | 1/4   | 101008   | AA-223            |
|                            |       | 3/8   | 101009   | AA-223-1          |
| <b>1/8 X 1/4 NOMINAL</b>   |       |       |          |                   |
| .127                       | .252  | 1/8   | 301001   | B-24-1            |
|                            |       | 1/4   | 301002   | B-24-2            |
|                            |       | 3/8   | 301003   | B-24-3            |
|                            |       | 1/2   | 301004   | B-24-4            |
| .127                       | .252  | 1/8   | 401003   | SS-48-2           |
|                            |       | 1/4   | 401004   | SS-48-4           |
|                            |       | 3/8   | 401005   | SS-48-6           |
|                            |       | 1/2   | 401006   | SS-48-8           |
| .127                       | .253  | 1/8   | 201003   | EP020402 (P-13-1) |
|                            |       | 1/4   | 201004   | EP020404 (P-13-2) |
|                            |       | 3/8   | 201005   | EP020406 (P-13-3) |
|                            |       | 1/2   | 201006   | EP020408 (P-13-4) |
| .128                       | .253  | 1/4   | 101010   | AA-224            |
|                            |       | 3/8   | 101011   | AA-224-1          |
| <b>1/8 X 5/16 NOMINAL</b>  |       |       |          |                   |
| .127                       | .3145 | 1/4   | 401007   | SS-410-4          |
|                            |       | 3/8   | 401008   | SS-410-6          |
|                            |       | 1/2   | 401009   | SS-410-8          |
| .127                       | .315  | 1/8   | 301005   | B-25-1            |
|                            |       | 1/4   | 301006   | B-25-2            |
|                            |       | 3/8   | 301007   | B-25-3            |
|                            |       | 1/2   | 301008   | B-25-4            |
|                            |       | 5/8   | 301009   | B-25-5            |
| .127                       | .3155 | 1/8   | 201007   | EP020502 (P-14-1) |
|                            |       | 1/4   | 201008   | EP020504 (P-14-2) |
|                            |       | 3/8   | 201009   | EP020506 (P-14-3) |
|                            |       | 1/2   | 201010   | EP020508 (P-14-4) |
| <b>1/8 X 3/8 NOMINAL</b>   |       |       |          |                   |
| .127                       | .377  | 1/4   | 101012   | AA-337-2          |
|                            |       | 1/2   | 101013   | AA-337-3          |
| <b>5/32 X 7/32 NOMINAL</b> |       |       |          |                   |
| .156                       | .220  | 1/4   | 101014   | AA-211            |
|                            |       | 3/8   | 101015   | AA-211-1          |

| ID                        | OD    | LGTH. | ITEM NO. | PART NO.            |
|---------------------------|-------|-------|----------|---------------------|
| <b>5/32 X 1/4 NOMINAL</b> |       |       |          |                     |
| .1565                     | .2525 | 3/8   | 101016   | AA-238              |
|                           |       | 1/4   | 101017   | AA-204-1            |
| .159                      | .253  | 1/4   | 101018   | AA-204              |
|                           |       | 5/16  | 101018   | AA-204              |
| <b>3/16 X 1/4 NOMINAL</b> |       |       |          |                     |
| .1875                     | .252  | 1/4   | 101019   | AA-225-2            |
|                           |       | 5/16  | 101020   | AA-225-1            |
|                           |       | 3/8   | 101021   | AA-225-6            |
|                           |       | 1/2   | 101022   | AA-225-4            |
|                           |       | 5/8   | 101023   | AA-225-3            |
| .1885                     | .252  | 1/4   | 101024   | AA-226-1            |
|                           |       | 3/8   | 101025   | AA-226-2            |
|                           |       | 7/16  | 101026   | AA-226              |
|                           |       | 1/2   | 101027   | AA-226-3            |
|                           |       | 5/8   | 101028   | AA-226-4            |
| .189                      | .252  | 1/4   | 301010   | B-34-2              |
|                           |       | 3/8   | 301011   | B-34-3              |
|                           |       | 1/2   | 301012   | B-34-4              |
|                           |       | 5/8   | 301013   | B-34-5              |
|                           |       | 3/4   | 301014   | B-34-6              |
|                           |       | 1/4   | 401010   | SS-68-4             |
| .189                      | .252  | 3/8   | 401011   | SS-68-6             |
|                           |       | 1/2   | 401012   | SS-68-8             |
|                           |       | 5/8   | 401013   | SS-68-10            |
|                           |       | 3/4   | 401014   | SS-68-12            |
|                           |       | 1/4   | 201011   | EP030404 (P-18-2)   |
| .1895                     | .253  | 3/8   | 201012   | EP030406 (P-18-3)   |
|                           |       | 1/2   | 201013   | EP030408 (P-18-4)   |
| .189                      | .314  | 1/4   | 301015   | B-35-2              |
|                           |       | 3/8   | 301016   | B-35-3              |
| .1895                     | .3145 | 1/2   | 301017   | B-35-4              |
|                           |       | 5/8   | 301018   | B-35-5              |
|                           |       | 3/4   | 301019   | B-35-6              |
| .1895                     | .3155 | 3/16  | 101037   | AA-331              |
|                           |       | 1/4   | 101038   | AA-331-2            |
|                           |       | 3/8   | 101039   | AA-331-3            |
| .1895                     | .3155 | 3/16  | 201554   | EP030503 (P-19-1.5) |
|                           |       | 1/4   | 201016   | EP030504 (P-19-2)   |
|                           |       | 5/16  | 201555   | EP030505 (P-19-2.5) |
|                           |       | 3/8   | 201017   | EP030506 (P-19-3)   |

| ID                        | OD    | LGTH.                      | ITEM NO. | PART NO.          |
|---------------------------|-------|----------------------------|----------|-------------------|
| .1895                     | .3155 | 1/2                        | 201018   | EP030508 (P-19-4) |
|                           |       | 5/8                        | 201019   | EP030510 (P-19-5) |
|                           |       | 3/4                        | 201020   | EP030512 (P-19-6) |
|                           |       | 1                          | 201021   | EP030516 (P-19-8) |
| .190                      | .3145 | 1/4                        | 401015   | SS-610-4          |
|                           |       | 3/8                        | 401016   | SS-610-6          |
|                           |       | 1/2                        | 401017   | SS-610-8          |
|                           |       | 5/8                        | 401018   | SS-610-10         |
|                           |       | 3/4                        | 401019   | SS-610-12         |
| .1885                     | .3775 | 1/4                        | 101040   | AA-346-1          |
|                           |       | 3/8                        | 101041   | AA-346-2          |
|                           |       | 1/2                        | 101042   | AA-346            |
| .1895                     | .378  | 1/4                        | 201556   | EP030604 (P-20-2) |
|                           |       | 3/8                        | 201022   | EP030606 (P-20-3) |
|                           |       | 1/2                        | 201023   | EP030608 (P-20-4) |
|                           |       | 5/8                        | 201024   | EP030610 (P-20-5) |
|                           |       | 3/4                        | 201025   | EP030612 (P-20-6) |
| .190                      | .377  | 3/8                        | 401021   | SS-612-6          |
|                           |       | 1/2                        | 401022   | SS-612-8          |
|                           |       | 5/8                        | 401023   | SS-612-10         |
| .219                      | .3145 | 5/16                       | 101043   | AA-318            |
|                           |       | 3/8                        | 101044   | AA-318-1          |
|                           |       | <b>7/32 X 5/16 NOMINAL</b> |          |                   |
| .219                      | .440  | 1/2                        | 101045   | AA-410-2          |
|                           |       | 3/4                        | 101046   | AA-410-3          |
| <b>1/4 X 5/16 NOMINAL</b> |       |                            |          |                   |
| .2505                     | .3145 | 1/4                        | 101047   | AA-397-1          |
|                           |       | 1/2                        | 101048   | AA-397            |
| .2515                     | .3155 | 1/4                        | 101049   | AA-347-2          |
|                           |       | 3/8                        | 101050   | AA-347-3          |
| .252                      | .315  | 1/2                        | 301455   | B-45-4            |
|                           |       | 1/4                        | 401025   | SS-810-4          |
| .252                      | .315  | 3/8                        | 401026   | SS-810-6          |
|                           |       | 1/2                        | 401027   | SS-810-8          |
|                           |       | 3/4                        | 401028   | SS-810-12         |
| .252                      | .3155 | 1/4                        | 201026   | EP040504 (P-25-2) |
|                           |       | 3/8                        | 201027   | EP040506 (P-25-3) |
|                           |       | 1/2                        | 201028   | EP040508 (P-25-4) |
|                           |       | 5/8                        | 201557   | EP040510 (P-25-5) |
| .253                      | .3155 | 3/4                        | 201029   | EP040512 (P-25-6) |
|                           |       | 1/2                        | 101051   | AA-335-4          |
|                           |       | 5/8                        | 101052   | AA-335-6          |
| .2505                     | .377  | 1/4                        | 101053   | AA-335-5          |
|                           |       | <b>1/4 X 3/8 NOMINAL</b>   |          |                   |
| .2505                     | .377  | 1/4                        | 101054   | AA-304-35         |

\*Other sizes, tolerances, lubricants and materials are available on special orders.





| ID                               | OD    | LGTH. | ITEM NO. | PART NO.            |
|----------------------------------|-------|-------|----------|---------------------|
| <b>1/4 X 3/8 NOMINAL (cont.)</b> |       |       |          |                     |
| .2505                            | .377  | 5/16  | 101055   | AA-304-9            |
|                                  |       | 3/8   | 101056   | AA-304-7            |
|                                  |       | 7/16  | 101057   | AA-304-24           |
|                                  |       | 1/2   | 101058   | AA-304-2            |
|                                  |       | 9/16  | 101059   | AA-304-5            |
|                                  |       | 5/8   | 101060   | AA-304-1            |
|                                  |       | 3/4   | 101061   | AA-304-22           |
|                                  |       | 7/8   | 101062   | AA-304-21           |
|                                  |       | 1     | 101063   | AA-304-20           |
|                                  |       | 1-1/8 | 101064   | AA-304-33           |
|                                  |       | 1-1/4 | 101065   | AA-304-11           |
| .252                             | .377  | 1/4   | 101066   | AA-307              |
|                                  |       | 5/16  | 101067   | AA-307-1            |
|                                  |       | 3/8   | 101068   | AA-307-9            |
|                                  |       | 1/2   | 101069   | AA-307-3            |
|                                  |       | 5/8   | 101070   | AA-307-10           |
|                                  |       | 3/4   | 101071   | AA-307-11           |
|                                  |       | 1     | 101072   | AA-307-2            |
|                                  |       | 1-1/8 | 101073   | AA-307-13           |
| .252                             | .377  | 1/4   | 301020   | B-46-2              |
|                                  |       | 5/16  | 301021   | B-46-2-1/2          |
|                                  |       | 3/8   | 301022   | B-46-3              |
|                                  |       | 1/2   | 301023   | B-46-4              |
|                                  |       | 5/8   | 301024   | B-46-5              |
|                                  |       | 3/4   | 301025   | B-46-6              |
|                                  |       | 7/8   | 301026   | B-46-7              |
|                                  |       | 1     | 301027   | B-46-8              |
|                                  |       | 1-1/4 | 301028   | B-46-10             |
| .252                             | .377  | 1/4   | 401029   | SS-812-4            |
|                                  |       | 3/8   | 401030   | SS-812-6            |
|                                  |       | 1/2   | 401031   | SS-812-8            |
|                                  |       | 5/8   | 401032   | SS-812-10           |
|                                  |       | 3/4   | 401033   | SS-812-12           |
|                                  |       | 7/8   | 401034   | SS-812-14           |
|                                  |       | 1     | 401035   | SS-812-16           |
|                                  |       | 1-1/4 | 401036   | SS-812-20           |
| .252                             | .378  | 1/4   | 201030   | EP040604 (P-26-2)   |
|                                  |       | 5/16  | 201558   | EP040605 (P-26-2.5) |
|                                  |       | 3/8   | 201031   | EP040606 (P-26-3)   |
|                                  |       | 7/16  | 201559   | EP040607 (P-26-3.5) |
|                                  |       | 1/2   | 201032   | EP040608 (P-26-4)   |
|                                  |       | 5/8   | 201033   | EP040610 (P-26-5)   |
|                                  |       | 3/4   | 201034   | EP040612 (P-26-6)   |
|                                  |       | 7/8   | 201035   | EP040614 (P-26-7)   |
|                                  |       | 1     | 201036   | EP040616 (P-26-8)   |
|                                  |       | 1-1/8 | 201037   | EP040618 (P-26-9)   |
|                                  |       | 1-1/4 | 201038   | EP040620 (P-26-10)  |
| .253                             | .377  | 1/4   | 101074   | AA-385-1            |
|                                  |       | 1/2   | 101075   | AA-385              |
|                                  |       | 3/4   | 101076   | AA-385-2            |
| <b>1/4 X 7/16 NOMINAL</b>        |       |       |          |                     |
| .251                             | .4395 | 3/8   | 101077   | AA-430              |

| ID                        | OD    | LGTH. | ITEM NO. | PART NO.            |
|---------------------------|-------|-------|----------|---------------------|
| .251                      | .4395 | 1/2   | 101078   | AA-430-1            |
|                           |       | 5/8   | 101079   | AA-430-5            |
|                           |       | 3/4   | 101080   | AA-430-2            |
|                           |       | 7/8   | 101081   | AA-430-6            |
|                           |       | 1     | 101082   | AA-430-3            |
| .252                      | .439  | 3/8   | 301029   | B-47-3              |
|                           |       | 1/2   | 301030   | B-47-4              |
|                           |       | 5/8   | 301031   | B-47-5              |
|                           |       | 3/4   | 301032   | B-47-6              |
|                           |       | 7/8   | 301033   | B-47-7              |
|                           |       | 1     | 301034   | B-47-8              |
| .252                      | .439  | 3/8   | 401037   | SS-814-6            |
|                           |       | 1/2   | 401038   | SS-814-8            |
|                           |       | 5/8   | 401039   | SS-814-10           |
|                           |       | 3/4   | 401040   | SS-814-12           |
|                           |       | 7/8   | 401041   | SS-814-14           |
|                           |       | 1     | 401042   | SS-814-16           |
| .252                      | .4395 | 3/8   | 101083   | AA-412-10           |
|                           |       | 1/2   | 101084   | AA-412-7            |
|                           |       | 5/8   | 101085   | AA-412-6            |
|                           |       | 3/4   | 101086   | AA-412-1            |
|                           |       | 1     | 101087   | AA-412-8            |
| .252                      | .4405 | 3/8   | 201039   | EP040706 (P-27-3)   |
|                           |       | 1/2   | 201040   | EP040708 (P-27-4)   |
|                           |       | 5/8   | 201041   | EP040710 (P-27-5)   |
|                           |       | 3/4   | 201042   | EP040712 (P-27-6)   |
|                           |       | 7/8   | 201043   | EP040714 (P-27-7)   |
|                           |       | 1     | 201044   | EP040716 (P-27-8)   |
| <b>1/4 X 1/2 NOMINAL</b>  |       |       |          |                     |
| .252                      | .5015 | 5/16  | 101088   | AA-519-4            |
|                           |       | 1/2   | 101089   | AA-519-1            |
|                           |       | 3/4   | 101090   | AA-519-2            |
|                           |       | 1     | 101091   | AA-519-3            |
| .252                      | .502  | 3/8   | 301035   | B-48-3              |
|                           |       | 1/2   | 301036   | B-48-4              |
|                           |       | 5/8   | 301037   | B-48-5              |
|                           |       | 3/4   | 301038   | B-48-6              |
|                           |       | 7/8   | 301039   | B-48-7              |
|                           |       | 1     | 301040   | B-48-8              |
|                           |       | 1-1/4 | 301041   | B-48-10             |
| .252                      | .503  | 5/16  | 201560   | EP040805 (P-28-2.5) |
|                           |       | 1/2   | 201045   | EP040808 (P-28-4)   |
|                           |       | 3/4   | 201046   | EP040812 (P-28-6)   |
|                           |       | 1     | 201047   | EP040816 (P-28-8)   |
|                           |       | 1-1/4 | 201048   | EP040820 (P-28-10)  |
| .252                      | .503  | 1/2   | 401043   | SS-816-8            |
|                           |       | 3/4   | 401044   | SS-816-12           |
|                           |       | 1     | 401045   | SS-816-16           |
|                           |       | 1-1/4 | 401046   | SS-816-20           |
| <b>5/16 X 3/8 NOMINAL</b> |       |       |          |                     |
| .3135                     | .377  | 1/4   | 101092   | AA-306-11           |
|                           |       | 5/16  | 101093   | AA-306-1            |

| ID                         | OD    | LGTH. | ITEM NO. | PART NO.          |
|----------------------------|-------|-------|----------|-------------------|
| .3135                      | .377  | 3/8   | 101094   | AA-306-3          |
|                            |       | 1/2   | 101095   | AA-306-7          |
|                            |       | 5/8   | 101096   | AA-306-8          |
|                            |       | 3/4   | 101097   | AA-306-6          |
| .314                       | .377  | 3/8   | 301042   | B-56-3            |
|                            |       | 1/2   | 301043   | B-56-4            |
|                            |       | 5/8   | 301044   | B-56-5            |
|                            |       | 3/4   | 301045   | B-56-6            |
|                            |       | 7/8   | 301046   | B-56-7            |
|                            |       | 1     | 301047   | B-56-8            |
| .3145                      | .378  | 1/4   | 201049   | EP050604 (P-31-2) |
|                            |       | 3/8   | 201050   | EP050606 (P-31-3) |
|                            |       | 1/2   | 201051   | EP050608 (P-31-4) |
|                            |       | 5/8   | 201052   | EP050610 (P-31-5) |
|                            |       | 3/4   | 201053   | EP050612 (P-31-6) |
|                            |       | 7/8   | 201054   | EP050614 (P-31-7) |
|                            |       | 1     | 201055   | EP050616 (P-31-8) |
| .3145                      | .378  | 1/4   | 401047   | SS-1012-4         |
|                            |       | 3/8   | 401048   | SS-1012-6         |
|                            |       | 1/2   | 401049   | SS-1012-8         |
|                            |       | 5/8   | 401050   | SS-1012-10        |
|                            |       | 3/4   | 401051   | SS-1012-12        |
|                            |       | 7/8   | 401052   | SS-1012-14        |
|                            |       | 1     | 401053   | SS-1012-16        |
| <b>5/16 X 7/16 NOMINAL</b> |       |       |          |                   |
| .3115                      | .441  | 3/8   | 101098   | AA-403            |
|                            |       | 1/2   | 101099   | AA-403-2          |
| .3125                      | .440  | 1/4   | 101100   | AA-407-1          |
|                            |       | 5/16  | 101101   | AA-407-10         |
|                            |       | 3/8   | 101102   | AA-407-7          |
|                            |       | 1/2   | 101103   | AA-407-3          |
|                            |       | 5/8   | 101104   | AA-407-2          |
|                            |       | 3/4   | 101105   | AA-407-4          |
| .3135                      | .4395 | 1/4   | 101106   | AA-401-17         |
|                            |       | 5/16  | 101107   | AA-401-25         |
|                            |       | 3/8   | 101110   | AA-401-2          |
|                            |       | 7/16  | 101108   | AA-401-20         |
|                            |       | 1/2   | 101111   | AA-401-3          |
|                            |       | 5/8   | 101112   | AA-401-21         |
|                            |       | 11/16 | 101109   | AA-401-11         |
|                            |       | 3/4   | 101113   | AA-401-5          |
|                            |       | 7/8   | 101114   | AA-401-12         |
|                            |       | 1     | 101115   | AA-401-1          |
|                            |       | 1-1/8 | 101116   | AA-401            |
|                            |       | 1-1/4 | 101117   | AA-401-6          |
|                            |       | 1-3/8 | 101118   | AA-401-8          |
| .314                       | .439  | 1/4   | 301048   | B-57-2            |
|                            |       | 3/8   | 301049   | B-57-3            |
|                            |       | 1/2   | 301050   | B-57-4            |
|                            |       | 5/8   | 301051   | B-57-5            |
|                            |       | 3/4   | 301052   | B-57-6            |
|                            |       | 7/8   | 301053   | B-57-7            |

\*Other sizes, tolerances, lubricants and materials are available on special orders.



| ID                                 | OD    | LGTH. | ITEM NO. | PART NO.            | ID                        | OD    | LGTH. | ITEM NO. | PART NO.           | ID                        | OD    | LGTH. | ITEM NO. | PART NO.            |
|------------------------------------|-------|-------|----------|---------------------|---------------------------|-------|-------|----------|--------------------|---------------------------|-------|-------|----------|---------------------|
| <b>5/16 X 7/16 NOMINAL (cont.)</b> |       |       |          |                     |                           |       |       |          |                    |                           |       |       |          |                     |
| .314                               | .439  | 1     | 301054   | B-57-8              | .3145                     | .503  | 7/8   | 201069   | EP050814 (P-33-7)  | .377                      | .502  | 1-1/4 | 301072   | B-68-10             |
|                                    |       | 1-1/4 | 301055   | B-57-10             |                           |       | 1     | 201070   | EP050816 (P-33-8)  | .377                      | .503  | 3/16  | 201563   | EP060803 (P-38-1.5) |
|                                    |       | 1-3/8 | 301056   | B-57-11             |                           |       | 1-1/4 | 201071   | EP050820 (P-33-10) |                           |       | 1/4   | 201077   | EP060804 (P-38-2)   |
| .3145                              | .440  | 1/4   | 401054   | SS-1014-4           |                           |       | 1-1/2 | 201072   | EP050824 (P-33-12) |                           |       | 5/16  | 201564   | EP060805 (P-38-2.5) |
|                                    |       | 3/8   | 401055   | SS-1014-6           | .3145                     | .503  | 3/8   | 401063   | SS-1016-6          |                           |       | 3/8   | 201078   | EP060806 (P-38-3)   |
|                                    |       | 1/2   | 401056   | SS-1014-8           |                           |       | 1/2   | 401064   | SS-1016-8          |                           |       | 7/16  | 201565   | EP060807 (P-38-3.5) |
|                                    |       | 5/8   | 401057   | SS-1014-10          |                           |       | 5/8   | 401065   | SS-1016-10         |                           |       | 1/2   | 201079   | EP060808 (P-38-4)   |
|                                    |       | 3/4   | 401058   | SS-1014-12          |                           |       | 3/4   | 401066   | SS-1016-12         |                           |       | 5/8   | 201080   | EP060810 (P-38-5)   |
|                                    |       | 7/8   | 401059   | SS-1014-14          |                           |       | 7/8   | 401067   | SS-1016-14         |                           |       | 3/4   | 201081   | EP060812 (P-38-6)   |
|                                    |       | 1     | 401060   | SS-1014-16          |                           |       | 1     | 401068   | SS-1016-16         |                           |       | 7/8   | 201082   | EP060814 (P-38-7)   |
|                                    |       | 1-1/8 | 401061   | SS-1014-18          |                           |       | 1-1/4 | 401069   | SS-1016-20         |                           |       | 1     | 201083   | EP060816 (P-38-8)   |
|                                    |       | 1-1/4 | 401062   | SS-1014-20          |                           |       | 1-1/2 | 401070   | SS-1016-24         |                           |       | 1-1/8 | 201084   | EP060818 (P-38-9)   |
|                                    |       |       |          |                     | <b>3/8 X 7/16 NOMINAL</b> |       |       |          |                    |                           |       |       |          |                     |
| .3145                              | .4405 | 1/4   | 201056   | EP050704 (P-32-2)   | .3765                     | .440  | 1/4   | 101135   | AA-432-4           | .378                      | .5025 | 1/4   | 101159   | AA-502-5            |
|                                    |       | 5/16  | 201561   | EP050705 (P-32-2.5) |                           |       | 3/8   | 101136   | AA-432-2           |                           |       | 1/2   | 101160   | AA-502              |
|                                    |       | 3/8   | 201057   | EP050706 (P-32-3)   |                           |       | 1/2   | 101137   | AA-432-1           |                           |       | 5/8   | 101161   | AA-502-3            |
|                                    |       | 1/2   | 201058   | EP050708 (P-32-4)   |                           |       | 3/4   | 101138   | AA-432-3           |                           |       | 3/4   | 101162   | AA-502-1            |
|                                    |       | 5/8   | 201059   | EP050710 (P-32-5)   |                           |       |       |          |                    |                           |       | 1     | 101163   | AA-502-2            |
|                                    |       | 3/4   | 201060   | EP050712 (P-32-6)   | .377                      | .440  | 1/2   | 401071   | SS-1214-8          | .378                      | .503  | 1/4   | 401075   | SS-1216-4           |
|                                    |       | 7/8   | 201061   | EP050714 (P-32-7)   |                           |       | 5/8   | 401072   | SS-1214-10         |                           |       | 3/8   | 401076   | SS-1216-6           |
|                                    |       | 1     | 201062   | EP050716 (P-32-8)   |                           |       | 3/4   | 401073   | SS-1214-12         |                           |       | 1/2   | 401077   | SS-1216-8           |
|                                    |       | 1-1/8 | 201063   | EP050718 (P-32-9)   |                           |       | 1     | 401074   | SS-1214-16         |                           |       | 5/8   | 401078   | SS-1216-10          |
|                                    |       | 1-1/4 | 201064   | EP050720 (P-32-10)  |                           |       |       |          |                    |                           |       | 3/4   | 401079   | SS-1216-12          |
| .3155                              | .4395 | 1/4   | 101119   | AA-417-7            | .377                      | .4405 | 1/2   | 201073   | EP060708 (P-37-4)  |                           |       | 7/8   | 401080   | SS-1216-14          |
|                                    |       | 1/2   | 101120   | AA-417              |                           |       | 5/8   | 201074   | EP060710 (P-37-5)  |                           |       | 1     | 401081   | SS-1216-16          |
|                                    |       | 3/4   | 101121   | AA-417-3            |                           |       | 3/4   | 201075   | EP060712 (P-37-6)  |                           |       | 1-1/8 | 401082   | SS-1216-18          |
|                                    |       |       |          |                     | <b>3/8 X 1/2 NOMINAL</b>  |       |       |          |                    |                           |       |       |          |                     |
| .3125                              | .503  | 3/8   | 101122   | AA-520-8            | .375                      | .503  | 1/4   | 101139   | AA-521-4           |                           |       | 1-1/4 | 401083   | SS-1216-20          |
|                                    |       | 1/2   | 101123   | AA-520-3            |                           |       | 3/8   | 101140   | AA-521-9           | <b>3/8 X 9/16 NOMINAL</b> |       |       |          |                     |
|                                    |       | 5/8   | 101124   | AA-520-4            |                           |       | 7/16  | 101141   | AA-521-8           | .3765                     | .5655 | 3/8   | 101164   | AA-516-5            |
|                                    |       | 3/4   | 101125   | AA-520-1            |                           |       | 1/2   | 101142   | AA-521-1           |                           |       | 1/2   | 101165   | AA-516-6            |
|                                    |       | 7/8   | 101126   | AA-520-2            |                           |       | 5/8   | 101143   | AA-521-10          |                           |       | 9/16  | 101166   | AA-516-3            |
|                                    |       | 1     | 101127   | AA-520-5            |                           |       | 3/4   | 101144   | AA-521             |                           |       | 11/16 | 101167   | AA-516              |
| .314                               | .502  | 3/8   | 301057   | B-58-3              |                           |       | 7/8   | 101145   | AA-521-2           |                           |       | 3/4   | 101168   | AA-516-10           |
|                                    |       | 1/2   | 301058   | B-58-4              |                           |       | 1     | 101146   | AA-521-11          |                           |       | 1     | 101169   | AA-516-8            |
|                                    |       | 5/8   | 301059   | B-58-5              |                           |       | 1-1/4 | 101147   | AA-521-12          |                           |       | 1-1/4 | 101170   | AA-516-2            |
|                                    |       | 3/4   | 301060   | B-58-6              | .3765                     | .503  | 3/16  | 101148   | AA-507-12          | .377                      | .5645 | 3/8   | 301073   | B-69-3              |
|                                    |       | 7/8   | 301061   | B-58-7              |                           |       | 1/4   | 101149   | AA-507-19          |                           |       | 1/2   | 301074   | B-69-4              |
|                                    |       | 1     | 301062   | B-58-8              |                           |       | 5/16  | 101150   | AA-507-13          |                           |       | 5/8   | 301075   | B-69-5              |
|                                    |       | 1-1/4 | 301063   | B-58-10             |                           |       | 3/8   | 101151   | AA-507-11          |                           |       | 3/4   | 301076   | B-69-6              |
|                                    |       | 1-1/2 | 301064   | B-58-12             |                           |       | 7/16  | 101152   | AA-507-4           |                           |       | 7/8   | 301077   | B-69-7              |
|                                    |       | 1-3/4 | 301065   | B-58-14             |                           |       | 1/2   | 101153   | AA-507-10          |                           |       | 1     | 301078   | B-69-8              |
| .314                               | .503  | 1/4   | 101128   | AA-506-16           |                           |       | 5/8   | 101154   | AA-507-5           |                           |       | 1-1/4 | 301079   | B-69-10             |
|                                    |       | 3/8   | 101129   | AA-506-2            |                           |       | 3/4   | 101155   | AA-507-2           | .377                      | .5655 | 3/8   | 201086   | EP060906 (P-39-3)   |
|                                    |       | 1/2   | 101130   | AA-506-7            |                           |       | 7/8   | 101156   | AA-507-3           |                           |       | 1/2   | 201087   | EP060908 (P-39-4)   |
|                                    |       | 9/16  | 101131   | AA-506-1            |                           |       | 1     | 101157   | AA-507-23          |                           |       | 5/8   | 201088   | EP060910 (P-39-5)   |
|                                    |       | 5/8   | 101132   | AA-506-3            |                           |       | 1-1/8 | 101158   | AA-507-17          |                           |       | 3/4   | 201089   | EP060912 (P-39-6)   |
|                                    |       | 3/4   | 101133   | AA-506-8            |                           |       |       |          |                    |                           |       | 7/8   | 201090   | EP060914 (P-39-7)   |
|                                    |       | 1     | 101134   | AA-506-9            | .377                      | .502  | 3/8   | 301066   | B-68-3             |                           |       | 1     | 201091   | EP060916 (P-39-8)   |
| .3145                              | .503  | 3/8   | 201065   | EP050806 (P-33-3)   |                           |       | 1/2   | 301067   | B-68-4             |                           |       | 1-1/4 | 201092   | EP060920 (P-39-10)  |
|                                    |       | 1/2   | 201066   | EP050808 (P-33-4)   |                           |       | 5/8   | 301068   | B-68-5             | .378                      | .565  | 3/8   | 401084   | SS-1218-6           |
|                                    |       | 5/8   | 201067   | EP050810 (P-33-5)   |                           |       | 3/4   | 301069   | B-68-6             |                           |       | 1/2   | 401085   | SS-1218-8           |
|                                    |       | 3/4   | 201068   | EP050812 (P-33-6)   |                           |       | 7/8   | 301070   | B-68-7             |                           |       | 5/8   | 401086   | SS-1218-10          |
|                                    |       |       |          |                     |                           |       | 1     | 301071   | B-68-8             |                           |       |       |          |                     |

\*Other sizes, tolerances, lubricants and materials are available on special orders.



| ID                                | OD   | LGTH. | ITEM NO. | PART NO.           |
|-----------------------------------|------|-------|----------|--------------------|
| <b>3/8 X 9/16 NOMINAL (cont.)</b> |      |       |          |                    |
| .378                              | .565 | 3/4   | 401087   | SS-1218-12         |
|                                   |      | 7/8   | 401088   | SS-1218-14         |
|                                   |      | 1     | 401089   | SS-1218-16         |
|                                   |      | 1-1/4 | 401090   | SS-1218-20         |
| <b>3/8 X 5/8 NOMINAL</b>          |      |       |          |                    |
| .376                              | .627 | 3/8   | 101171   | AA-630-8           |
|                                   |      | 7/16  | 101172   | AA-630-16          |
|                                   |      | 1/2   | 101173   | AA-630-11          |
|                                   |      | 5/8   | 101174   | AA-630-6           |
|                                   |      | 3/4   | 101175   | AA-630-12          |
|                                   |      | 7/8   | 101176   | AA-630             |
|                                   |      | 1     | 101177   | AA-630-7           |
|                                   |      | 1-1/8 | 101178   | AA-630-1           |
|                                   |      | 1-1/4 | 101179   | AA-630-2           |
| .377                              | .627 | 3/8   | 301080   | B-610-3            |
|                                   |      | 1/2   | 301081   | B-610-4            |
|                                   |      | 5/8   | 301082   | B-610-5            |
|                                   |      | 3/4   | 301083   | B-610-6            |
|                                   |      | 7/8   | 301084   | B-610-7            |
|                                   |      | 1     | 301085   | B-610-8            |
|                                   |      | 1-1/4 | 301086   | B-610-10           |
| .377                              | .628 | 3/8   | 201093   | EP061006 (P-40-3)  |
|                                   |      | 1/2   | 201094   | EP061008 (P-40-4)  |
|                                   |      | 5/8   | 201095   | EP061010 (P-40-5)  |
|                                   |      | 3/4   | 201096   | EP061012 (P-40-6)  |
|                                   |      | 7/8   | 201097   | EP061014 (P-40-7)  |
|                                   |      | 1     | 201098   | EP061016 (P-40-8)  |
|                                   |      | 1-1/4 | 201099   | EP061020 (P-40-10) |
| .378                              | .628 | 3/8   | 401091   | SS-1220-6          |
|                                   |      | 1/2   | 401092   | SS-1220-8          |
|                                   |      | 5/8   | 401093   | SS-1220-10         |
|                                   |      | 3/4   | 401094   | SS-1220-12         |
|                                   |      | 7/8   | 401095   | SS-1220-14         |
|                                   |      | 1     | 401096   | SS-1220-16         |
|                                   |      | 1-1/4 | 401097   | SS-1220-20         |
|                                   |      | 1-1/2 | 401098   | SS-1220-24         |
| <b>3/8 X 11/16 NOMINAL</b>        |      |       |          |                    |
| .3765                             | .689 | 3/4   | 101180   | AA-615             |
|                                   |      | 1-1/2 | 101181   | AA-615-2           |
| <b>3/8 X 3/4 NOMINAL</b>          |      |       |          |                    |
| .377                              | .753 | 1/2   | 101182   | AA-707-2           |
|                                   |      | 3/4   | 101183   | AA-707-3           |
|                                   |      | 1     | 101184   | AA-707             |
|                                   |      | 1-1/4 | 101185   | AA-707-4           |
| .377                              | .753 | 3/8   | 301087   | B-612-3            |
|                                   |      | 1/2   | 301088   | B-612-4            |
|                                   |      | 3/4   | 301089   | B-612-6            |
|                                   |      | 1     | 301090   | B-612-8            |
|                                   |      | 1-1/4 | 301091   | B-612-10           |
| .377                              | .753 | 3/8   | 201100   | EP061206 (P-41-3)  |

| ID                         | OD    | LGTH. | ITEM NO. | PART NO.           |
|----------------------------|-------|-------|----------|--------------------|
| .377                       | .753  | 1/2   | 201101   | EP061208 (P-41-4)  |
|                            |       | 3/4   | 201102   | EP061212 (P-41-6)  |
|                            |       | 1     | 201103   | EP061216 (P-41-8)  |
|                            |       | 1-1/4 | 201104   | EP061220 (P-41-10) |
| .378                       | .753  | 3/8   | 401099   | SS-1224-6          |
|                            |       | 1/2   | 401100   | SS-1224-8          |
|                            |       | 3/4   | 401101   | SS-1224-12         |
|                            |       | 1     | 401102   | SS-1224-16         |
|                            |       | 1-1/4 | 401103   | SS-1224-20         |
| <b>7/16 X 9/16 NOMINAL</b> |       |       |          |                    |
| .439                       | .5645 | 3/8   | 301092   | B-79-3             |
|                            |       | 1/2   | 301093   | B-79-4             |
|                            |       | 5/8   | 301094   | B-79-5             |
|                            |       | 3/4   | 301095   | B-79-6             |
|                            |       | 7/8   | 301096   | B-79-7             |
|                            |       | 1     | 301097   | B-79-8             |
|                            |       | 1-1/4 | 301098   | B-79-10            |
| .439                       | .565  | 5/16  | 101186   | AA-515-1           |
|                            |       | 3/8   | 101187   | AA-515-21          |
|                            |       | 1/2   | 101188   | AA-515-2           |
|                            |       | 5/8   | 101189   | AA-515-3           |
|                            |       | 3/4   | 101190   | AA-515             |
|                            |       | 13/16 | 101191   | AA-515-12          |
|                            |       | 15/16 | 101192   | AA-515-6           |
|                            |       | 1     | 101193   | AA-515-8           |
| .4395                      | .5655 | 3/8   | 201105   | EP070906 (P-43-3)  |
|                            |       | 1/2   | 201106   | EP070908 (P-43-4)  |
|                            |       | 5/8   | 201107   | EP070910 (P-43-5)  |
|                            |       | 3/4   | 201108   | EP070912 (P-43-6)  |
|                            |       | 7/8   | 201109   | EP070914 (P-43-7)  |
|                            |       | 1     | 201110   | EP070916 (P-43-8)  |
|                            |       | 1-1/4 | 201111   | EP070920 (P-43-10) |
| .440                       | .565  | 3/8   | 401104   | SS-1418-6          |
|                            |       | 1/2   | 401105   | SS-1418-8          |
|                            |       | 5/8   | 401106   | SS-1418-10         |
|                            |       | 3/4   | 401107   | SS-1418-12         |
|                            |       | 7/8   | 401108   | SS-1418-14         |
|                            |       | 1     | 401109   | SS-1418-16         |
|                            |       | 1-1/4 | 401110   | SS-1418-20         |
| <b>7/16 X 5/8 NOMINAL</b>  |       |       |          |                    |
| .439                       | .627  | 3/8   | 101194   | AA-627-5           |
|                            |       | 7/16  | 101195   | AA-627-13          |
|                            |       | 1/2   | 101196   | AA-627-8           |
|                            |       | 5/8   | 101197   | AA-627-3           |
|                            |       | 3/4   | 101198   | AA-627             |
|                            |       | 1     | 101199   | AA-627-4           |
|                            |       | 1-1/4 | 101200   | AA-627-1           |
|                            |       | 1-1/2 | 101201   | AA-627-7           |
| .439                       | .628  | 3/8   | 301099   | B-710-3            |
|                            |       | 1/2   | 301100   | B-710-4            |
|                            |       | 5/8   | 301101   | B-710-5            |

| ID                          | OD    | LGTH. | ITEM NO. | PART NO.            |
|-----------------------------|-------|-------|----------|---------------------|
| .439                        | .628  | 3/4   | 301102   | B-710-6             |
|                             |       | 7/8   | 301103   | B-710-7             |
|                             |       | 1     | 301104   | B-710-8             |
|                             |       | 1-1/4 | 301105   | B-710-10            |
| .4395                       | .628  | 3/8   | 201112   | EP071006 (P-44-3)   |
|                             |       | 1/2   | 201113   | EP071008 (P-44-4)   |
|                             |       | 5/8   | 201114   | EP071010 (P-44-5)   |
|                             |       | 3/4   | 201115   | EP071012 (P-44-6)   |
|                             |       | 7/8   | 201116   | EP071014 (P-44-7)   |
|                             |       | 1     | 201117   | EP071016 (P-44-8)   |
|                             |       | 1-1/4 | 201118   | EP071020 (P-44-10)  |
|                             |       | 1-1/2 | 201119   | EP071024 (P-44-12)  |
| .440                        | .628  | 3/8   | 401111   | SS-1420-6           |
|                             |       | 1/2   | 401112   | SS-1420-8           |
|                             |       | 5/8   | 401113   | SS-1420-10          |
|                             |       | 3/4   | 401114   | SS-1420-12          |
|                             |       | 7/8   | 401115   | SS-1420-14          |
|                             |       | 1     | 401116   | SS-1420-16          |
|                             |       | 1-1/4 | 401117   | SS-1420-20          |
|                             |       | 1-1/2 | 401118   | SS-1420-24          |
| <b>7/16 X 11/16 NOMINAL</b> |       |       |          |                     |
| .439                        | .690  | 1/2   | 301106   | B-711-4             |
|                             |       | 1     | 301107   | B-711-8             |
|                             |       | 1-1/2 | 301108   | B-711-12            |
| .4395                       | .6905 | 1/2   | 201120   | EP071108 (P-45-4)   |
|                             |       | 1     | 201121   | EP071116 (P-45-8)   |
|                             |       | 1-1/2 | 201122   | EP071124 (P-45-12)  |
| .4395                       | .6905 | 1/2   | 401119   | SS-1422-8           |
|                             |       | 1     | 401120   | SS-1422-16          |
|                             |       | 1-1/2 | 401121   | SS-1422-24          |
| <b>1/2 X 5/8 NOMINAL</b>    |       |       |          |                     |
| .5015                       | .628  | 5/16  | 101202   | AA-628-21           |
|                             |       | 3/8   | 101203   | AA-628-7            |
|                             |       | 7/16  | 101204   | AA-628-8            |
|                             |       | 1/2   | 101205   | AA-628-10           |
|                             |       | 9/16  | 101206   | AA-628-3            |
|                             |       | 5/8   | 101207   | AA-628-25           |
|                             |       | 11/16 | 101208   | AA-628-12           |
|                             |       | 3/4   | 101209   | AA-628-6            |
|                             |       | 7/8   | 101210   | AA-628-20           |
|                             |       | 1     | 101211   | AA-628              |
|                             |       | 1-1/4 | 101212   | AA-628-11           |
|                             |       | 1-1/2 | 101213   | AA-628-5            |
| .502                        | .628  | 1/2   | 301109   | B-810-4             |
|                             |       | 5/8   | 301110   | B-810-5             |
|                             |       | 3/4   | 301111   | B-810-6             |
|                             |       | 7/8   | 301112   | B-810-7             |
|                             |       | 1     | 301113   | B-810-8             |
|                             |       | 1-1/8 | 301114   | B-810-9             |
|                             |       | 1-1/4 | 301115   | B-810-10            |
|                             |       | 1-1/2 | 301116   | B-810-12            |
| .502                        | .628  | 5/16  | 201566   | EP081005 (P-50-2.5) |

\*Other sizes, tolerances, lubricants and materials are available on special orders.



| ID                               | OD    | LGTH. | ITEM NO. | PART NO.   |            | ID                         | OD    | LGTH. | ITEM NO. | PART NO.   |           | ID                       | OD    | LGTH. | ITEM NO. | PART NO.   |           |  |  |  |  |  |  |  |  |  |  |  |  |
|----------------------------------|-------|-------|----------|------------|------------|----------------------------|-------|-------|----------|------------|-----------|--------------------------|-------|-------|----------|------------|-----------|--|--|--|--|--|--|--|--|--|--|--|--|
| <b>1/2 X 5/8 NOMINAL (cont.)</b> |       |       |          |            |            |                            |       |       |          |            |           |                          |       |       |          |            |           |  |  |  |  |  |  |  |  |  |  |  |  |
| .502                             | .628  | 3/8   | 201123   | EP081006   | (P-50-3)   | .502                       | .6905 | 1     | 201136   | EP081116   | (P-51-8)  | .502                     | .753  | 1-1/4 | 201147   | EP081220   | (P-52-10) |  |  |  |  |  |  |  |  |  |  |  |  |
|                                  |       | 7/16  | 201567   | EP081007   | (P-50-3.5) |                            |       | 1-1/8 | 201137   | EP081118   | (P-51-9)  |                          |       | 1-1/2 | 201148   | EP081224   | (P-52-12) |  |  |  |  |  |  |  |  |  |  |  |  |
|                                  |       | 1/2   | 201124   | EP081008   | (P-50-4)   |                            |       | 1-1/4 | 201138   | EP081120   | (P-51-10) |                          |       | 1-3/4 | 201149   | EP081228   | (P-52-14) |  |  |  |  |  |  |  |  |  |  |  |  |
|                                  |       | 9/16  | 201568   | EP081009   | (P-50-4.5) |                            |       | 1-1/2 | 201139   | EP081124   | (P-51-12) |                          |       | 2     | 201150   | EP081232   | (P-52-16) |  |  |  |  |  |  |  |  |  |  |  |  |
|                                  |       | 5/8   | 201125   | EP081010   | (P-50-5)   | .5025                      | .689  | 3/8   | 101231   | AA-631-13  |           | .5025                    | .753  | 1/2   | 101253   | AA-744-5   |           |  |  |  |  |  |  |  |  |  |  |  |  |
|                                  |       | 11/16 | 201569   | EP081011   | (P-50-5.5) |                            |       | 3/4   | 101232   | AA-631     |           |                          |       | 5/8   | 101254   | AA-744-9   |           |  |  |  |  |  |  |  |  |  |  |  |  |
|                                  |       | 3/4   | 201126   | EP081012   | (P-50-6)   |                            |       | 1-1/4 | 101233   | AA-631-1   |           |                          |       | 3/4   | 101255   | AA-744-4   |           |  |  |  |  |  |  |  |  |  |  |  |  |
|                                  |       | 7/8   | 201127   | EP081014   | (P-50-7)   | .503                       | .690  | 1/2   | 401131   | SS-1622-8  |           |                          |       | 7/8   | 101256   | AA-744-10  |           |  |  |  |  |  |  |  |  |  |  |  |  |
|                                  |       | 1     | 201128   | EP081016   | (P-50-8)   |                            |       | 5/8   | 401132   | SS-1622-10 |           |                          |       | 1     | 101257   | AA-744-3   |           |  |  |  |  |  |  |  |  |  |  |  |  |
|                                  |       | 1-1/8 | 201129   | EP081018   | (P-50-9)   |                            |       | 3/4   | 401133   | SS-1622-12 |           |                          |       | 1-1/4 | 101258   | AA-744     |           |  |  |  |  |  |  |  |  |  |  |  |  |
|                                  |       | 1-1/4 | 201130   | EP081020   | (P-50-10)  |                            |       | 7/8   | 401134   | SS-1622-14 |           |                          |       | 1-1/2 | 101259   | AA-744-1   |           |  |  |  |  |  |  |  |  |  |  |  |  |
|                                  |       | 1-1/2 | 201131   | EP081024   | (P-50-12)  |                            |       | 1     | 401135   | SS-1622-16 |           |                          |       | 1-3/4 | 101260   | AA-744-2   |           |  |  |  |  |  |  |  |  |  |  |  |  |
| .502                             | .628  | 3/8   | 401122   | SS-1620-6  |            |                            |       | 1-1/8 | 401136   | SS-1622-18 |           | .503                     | .753  | 3/8   | 401139   | SS-1624-6  |           |  |  |  |  |  |  |  |  |  |  |  |  |
|                                  |       | 1/2   | 401123   | SS-1620-8  |            |                            |       | 1-1/4 | 401137   | SS-1622-20 |           |                          |       | 1/2   | 401140   | SS-1624-8  |           |  |  |  |  |  |  |  |  |  |  |  |  |
|                                  |       | 5/8   | 401124   | SS-1620-10 |            | .504                       | .690  | 1/4   | 101234   | AA-618-16  |           |                          |       | 5/8   | 401141   | SS-1624-10 |           |  |  |  |  |  |  |  |  |  |  |  |  |
|                                  |       | 3/4   | 401125   | SS-1620-12 |            |                            |       | 1/2   | 101235   | AA-618-1   |           |                          |       | 3/4   | 401142   | SS-1624-12 |           |  |  |  |  |  |  |  |  |  |  |  |  |
|                                  |       | 7/8   | 401126   | SS-1620-14 |            |                            |       | 9/16  | 101236   | AA-618-13  |           |                          |       | 7/8   | 401143   | SS-1624-14 |           |  |  |  |  |  |  |  |  |  |  |  |  |
|                                  |       | 1     | 401127   | SS-1620-16 |            |                            |       | 5/8   | 101237   | AA-618-12  |           |                          |       | 1     | 401144   | SS-1624-16 |           |  |  |  |  |  |  |  |  |  |  |  |  |
|                                  |       | 1-1/8 | 401128   | SS-1620-18 |            |                            |       | 3/4   | 101238   | AA-618-11  |           |                          |       | 1-1/8 | 401145   | SS-1624-18 |           |  |  |  |  |  |  |  |  |  |  |  |  |
|                                  |       | 1-1/4 | 401129   | SS-1620-20 |            |                            |       | 7/8   | 101239   | AA-618-8   |           |                          |       | 1-1/4 | 401146   | SS-1624-20 |           |  |  |  |  |  |  |  |  |  |  |  |  |
|                                  |       | 1-1/2 | 401130   | SS-1620-24 |            |                            |       | 1     | 101240   | AA-618-6   |           |                          |       | 1-1/2 | 401147   | SS-1624-24 |           |  |  |  |  |  |  |  |  |  |  |  |  |
| .5025                            | .629  | 1/2   | 101214   | AA-607-1   |            |                            |       | 1-1/8 | 101241   | AA-618-2   |           |                          |       | 1-3/4 | 401148   | SS-1624-28 |           |  |  |  |  |  |  |  |  |  |  |  |  |
|                                  |       | 5/8   | 101215   | AA-607-2   |            |                            |       | 1-3/8 | 101242   | AA-618-5   |           |                          |       | 2     | 401149   | SS-1624-32 |           |  |  |  |  |  |  |  |  |  |  |  |  |
|                                  |       | 3/4   | 101216   | AA-607-5   |            | <b>1/2 X 13/16 NOMINAL</b> |       |       |          |            |           |                          |       |       |          |            |           |  |  |  |  |  |  |  |  |  |  |  |  |
|                                  |       | 1     | 101217   | AA-607-3   |            | .5005                      | .752  | 1/2   | 101243   | AA-742-1   |           | .501                     | .815  | 3/4   | 101261   | AA-886-3   |           |  |  |  |  |  |  |  |  |  |  |  |  |
|                                  |       | 1-1/4 | 101218   | AA-607-6   |            |                            |       | 3/4   | 101244   | AA-742-2   |           |                          |       | 1     | 101262   | AA-886-1   |           |  |  |  |  |  |  |  |  |  |  |  |  |
| .504                             | .6275 | 1/2   | 101219   | AA-634-4   |            |                            |       | 1     | 101245   | AA-742     |           |                          |       | 1-1/2 | 101263   | AA-886-4   |           |  |  |  |  |  |  |  |  |  |  |  |  |
|                                  |       | 1     | 101220   | AA-634-5   |            |                            |       | 1-1/8 | 101246   | AA-742-4   |           | .502                     | .815  | 1/2   | 301135   | B-813-4    |           |  |  |  |  |  |  |  |  |  |  |  |  |
| <b>1/2 X 11/16 NOMINAL</b>       |       |       |          |            |            |                            |       |       |          |            |           |                          |       |       |          |            |           |  |  |  |  |  |  |  |  |  |  |  |  |
| .5015                            | .690  | 3/8   | 101221   | AA-650-4   |            |                            |       | 1-1/4 | 101247   | AA-742-3   |           |                          |       | 3/4   | 301136   | B-813-6    |           |  |  |  |  |  |  |  |  |  |  |  |  |
|                                  |       | 1/2   | 101222   | AA-650-1   |            | .5015                      | .752  | 1/2   | 101248   | AA-753     |           |                          |       | 1     | 301137   | B-813-8    |           |  |  |  |  |  |  |  |  |  |  |  |  |
|                                  |       | 9/16  | 101223   | AA-650-6   |            |                            |       | 9/16  | 101249   | AA-753-1   |           |                          |       | 1-1/2 | 301138   | B-813-12   |           |  |  |  |  |  |  |  |  |  |  |  |  |
|                                  |       | 5/8   | 101224   | AA-650-9   |            |                            |       | 3/4   | 101250   | AA-753-5   |           | .502                     | .8165 | 1/2   | 201151   | EP081308   | (P-53-4)  |  |  |  |  |  |  |  |  |  |  |  |  |
|                                  |       | 3/4   | 101225   | AA-650     |            |                            |       | 1     | 101251   | AA-753-2   |           |                          |       | 3/4   | 201152   | EP081312   | (P-53-6)  |  |  |  |  |  |  |  |  |  |  |  |  |
|                                  |       | 7/8   | 101226   | AA-650-7   |            |                            |       | 1-1/2 | 101252   | AA-753-4   |           |                          |       | 1     | 201153   | EP081316   | (P-53-8)  |  |  |  |  |  |  |  |  |  |  |  |  |
|                                  |       | 1     | 101227   | AA-650-2   |            | .502                       | .753  | 1/2   | 301125   | B-812-4    |           |                          |       | 1-1/2 | 201154   | EP081324   | (P-53-12) |  |  |  |  |  |  |  |  |  |  |  |  |
|                                  |       | 1-1/8 | 101228   | AA-650-5   |            |                            |       | 5/8   | 301126   | B-812-5    |           | .503                     | .815  | 1/2   | 401150   | SS-1626-8  |           |  |  |  |  |  |  |  |  |  |  |  |  |
|                                  |       | 1-1/4 | 101229   | AA-650-12  |            |                            |       | 3/4   | 301127   | B-812-6    |           |                          |       | 3/4   | 401151   | SS-1626-12 |           |  |  |  |  |  |  |  |  |  |  |  |  |
|                                  |       | 1-1/2 | 101230   | AA-650-3   |            |                            |       | 7/8   | 301128   | B-812-7    |           |                          |       | 1     | 401152   | SS-1626-16 |           |  |  |  |  |  |  |  |  |  |  |  |  |
| .502                             | .690  | 1/2   | 301117   | B-811-4    |            |                            |       | 1     | 301129   | B-812-8    |           |                          |       | 1-1/2 | 401153   | SS-1626-24 |           |  |  |  |  |  |  |  |  |  |  |  |  |
|                                  |       | 5/8   | 301118   | B-811-5    |            |                            |       | 1-1/8 | 301130   | B-812-9    |           | <b>1/2 X 7/8 NOMINAL</b> |       |       |          |            |           |  |  |  |  |  |  |  |  |  |  |  |  |
|                                  |       | 3/4   | 301119   | B-811-6    |            |                            |       | 1-1/4 | 301131   | B-812-10   |           | .502                     | .878  | 1/2   | 301139   | B-814-4    |           |  |  |  |  |  |  |  |  |  |  |  |  |
|                                  |       | 7/8   | 301120   | B-811-7    |            |                            |       | 1-1/2 | 301132   | B-812-12   |           |                          |       | 5/8   | 301140   | B-814-5    |           |  |  |  |  |  |  |  |  |  |  |  |  |
|                                  |       | 1     | 301121   | B-811-8    |            |                            |       | 1-3/4 | 301133   | B-812-14   |           |                          |       | 3/4   | 301141   | B-814-6    |           |  |  |  |  |  |  |  |  |  |  |  |  |
|                                  |       | 1-1/8 | 301122   | B-811-9    |            |                            |       | 2     | 301134   | B-812-16   |           |                          |       | 7/8   | 301142   | B-814-7    |           |  |  |  |  |  |  |  |  |  |  |  |  |
|                                  |       | 1-1/4 | 301123   | B-811-10   |            | .502                       | .753  | 3/8   | 201140   | EP081206   | (P-52-3)  |                          |       | 1     | 301143   | B-814-8    |           |  |  |  |  |  |  |  |  |  |  |  |  |
|                                  |       | 1-1/2 | 301124   | B-811-12   |            |                            |       | 1/2   | 201141   | EP081208   | (P-52-4)  |                          |       | 1-1/4 | 301144   | B-814-10   |           |  |  |  |  |  |  |  |  |  |  |  |  |
| .502                             | .6905 | 3/8   | 201570   | EP081106   | (P-51-3)   |                            |       | 5/8   | 201142   | EP081210   | (P-52-5)  |                          |       | 1-1/2 | 301145   | B-814-12   |           |  |  |  |  |  |  |  |  |  |  |  |  |
|                                  |       | 1/2   | 201132   | EP081108   | (P-51-4)   |                            |       | 3/4   | 201143   | EP081212   | (P-52-6)  | .502                     | .879  | 1/2   | 201155   | EP081408   | (P-54-4)  |  |  |  |  |  |  |  |  |  |  |  |  |
|                                  |       | 5/8   | 201133   | EP081110   | (P-51-5)   |                            |       | 7/8   | 201144   | EP081214   | (P-52-7)  |                          |       | 5/8   | 201156   | EP081410   | (P-54-5)  |  |  |  |  |  |  |  |  |  |  |  |  |
|                                  |       | 3/4   | 201134   | EP081112   | (P-51-6)   |                            |       | 1     | 201145   | EP081216   | (P-52-8)  |                          |       | 3/4   | 201157   | EP081412   | (P-54-6)  |  |  |  |  |  |  |  |  |  |  |  |  |
|                                  |       | 7/8   | 201135   | EP081114   | (P-51-7)   |                            |       | 1-1/8 | 201146   | EP081218   | (P-52-9)  |                          |       | 7/8   | 201158   | EP081414   | (P-54-7)  |  |  |  |  |  |  |  |  |  |  |  |  |

\*Other sizes, tolerances, lubricants and materials are available on special orders.



| ID                               | OD    | LGTH. | ITEM NO. | PART NO.           |
|----------------------------------|-------|-------|----------|--------------------|
| <b>1/2 X 7/8 NOMINAL (cont.)</b> |       |       |          |                    |
| .502                             | .879  | 1     | 201159   | EP081416 (P-54-8)  |
|                                  |       | 1-1/4 | 201160   | EP081420 (P-54-10) |
|                                  |       | 1-1/2 | 201161   | EP081424 (P-54-12) |
| .503                             | .878  | 1/2   | 401154   | SS-1628-8          |
|                                  |       | 5/8   | 401155   | SS-1628-10         |
|                                  |       | 3/4   | 401156   | SS-1628-12         |
|                                  |       | 7/8   | 401157   | SS-1628-14         |
|                                  |       | 1     | 401158   | SS-1628-16         |
|                                  |       | 1-1/4 | 401159   | SS-1628-20         |
|                                  |       | 1-1/2 | 401160   | SS-1628-24         |
| .503                             | .879  | 1/2   | 101264   | AA-842-7           |
|                                  |       | 3/4   | 101265   | AA-842-4           |
|                                  |       | 1     | 101266   | AA-842-3           |
|                                  |       | 1-1/4 | 101267   | AA-842-2           |
|                                  |       | 1-1/2 | 101268   | AA-842             |
| <b>1/2 X 1 NOMINAL</b>           |       |       |          |                    |
| .502                             | 1.004 | 3/4   | 201162   | EP081612 (P-55-6)  |
|                                  |       | 1     | 201163   | EP081616 (P-55-8)  |
|                                  |       | 1-1/2 | 201164   | EP081624 (P-55-12) |
|                                  |       | 2     | 201165   | EP081632 (P-55-16) |
| .503                             | 1.004 | 3/4   | 401161   | SS-1632-12         |
|                                  |       | 1     | 401162   | SS-1632-16         |
|                                  |       | 1-1/2 | 401163   | SS-1632-24         |
|                                  |       | 2     | 401164   | SS-1632-32         |
| <b>9/16 X 11/16 NOMINAL</b>      |       |       |          |                    |
| .5635                            | .691  | 7/16  | 101269   | AA-620-3           |
|                                  |       | 1/2   | 101270   | AA-620-7           |
|                                  |       | 5/8   | 101271   | AA-620-8           |
|                                  |       | 3/4   | 101272   | AA-620-1           |
|                                  |       | 1     | 101273   | AA-620             |
|                                  |       | 1-1/4 | 101274   | AA-620-5           |
| .5645                            | .6905 | 1/2   | 201166   | EP091108 (P-56-4)  |
|                                  |       | 5/8   | 201571   | EP091110 (P-56-5)  |
|                                  |       | 3/4   | 201167   | EP091112 (P-56-6)  |
|                                  |       | 1     | 201168   | EP091116 (P-56-8)  |
|                                  |       | 1-1/4 | 201169   | EP091120 (P-56-10) |
|                                  |       | 1-1/2 | 201170   | EP091124 (P-56-12) |
| .565                             | .690  | 1/2   | 401165   | SS-1822-8          |
|                                  |       | 3/4   | 401166   | SS-1822-12         |
|                                  |       | 1     | 401167   | SS-1822-16         |
|                                  |       | 1-1/4 | 401168   | SS-1822-20         |
|                                  |       | 1-1/2 | 401169   | SS-1822-24         |
| .565                             | .691  | 1/2   | 301146   | B-911-4            |
|                                  |       | 3/4   | 301147   | B-911-6            |
|                                  |       | 1     | 301148   | B-911-8            |
|                                  |       | 1-1/2 | 301149   | B-911-12           |
| .568                             | .689  | 1-1/8 | 101275   | AA-658-5           |
|                                  |       | 1-1/2 | 101276   | AA-658-1           |
| <b>9/16 X 3/4 NOMINAL</b>        |       |       |          |                    |
| .5635                            | .7535 | 5/8   | 101278   | AA-711-6           |
|                                  |       | 3/4   | 101279   | AA-711-1           |
|                                  |       | 1     | 101280   | AA-711-3           |

| ID                          | OD    | LGTH. | ITEM NO. | PART NO.           |
|-----------------------------|-------|-------|----------|--------------------|
| .5635                       | .7535 | 1-1/4 | 101281   | AA-711-5           |
|                             |       | 1-3/8 | 101282   | AA-711             |
|                             |       | 1-1/2 | 101283   | AA-711-2           |
| .5645                       | .753  | 1/2   | 201171   | EP091208 (P-57-4)  |
|                             |       | 3/4   | 201172   | EP091212 (P-57-6)  |
|                             |       | 1     | 201173   | EP091216 (P-57-8)  |
|                             |       | 1-1/4 | 201174   | EP091220 (P-57-10) |
|                             |       | 1-1/2 | 201175   | EP091224 (P-57-12) |
| .565                        | .753  | 1/2   | 301150   | B-912-4            |
|                             |       | 3/4   | 301151   | B-912-6            |
|                             |       | 1     | 301152   | B-912-8            |
|                             |       | 1-1/2 | 301153   | B-912-12           |
| .565                        | .753  | 1/2   | 401170   | SS-1824-8          |
|                             |       | 3/4   | 401171   | SS-1824-12         |
|                             |       | 1     | 401172   | SS-1824-16         |
|                             |       | 1-1/4 | 401173   | SS-1824-20         |
|                             |       | 1-1/2 | 401174   | SS-1824-24         |
| .566                        | .753  | 1/2   | 101284   | AA-709-7           |
|                             |       | 3/4   | 101285   | AA-709-8           |
|                             |       | 1     | 101286   | AA-709             |
|                             |       | 1-1/4 | 101287   | AA-709-5           |
|                             |       | 1-1/2 | 101288   | AA-709-6           |
| <b>9/16 X 13/16 NOMINAL</b> |       |       |          |                    |
| .563                        | .815  | 3/4   | 101289   | AA-807-3           |
|                             |       | 1     | 101290   | AA-807-2           |
|                             |       | 1-1/4 | 101291   | AA-807-4           |
| .5645                       | .8165 | 1/2   | 201176   | EP091308 (P-58-4)  |
|                             |       | 3/4   | 201177   | EP091312 (P-58-6)  |
|                             |       | 1     | 201178   | EP091316 (P-58-8)  |
|                             |       | 1-1/4 | 201179   | EP091320 (P-58-10) |
|                             |       | 1-1/2 | 201180   | EP091324 (P-58-12) |
| .565                        | .815  | 1/2   | 301154   | B-913-4            |
|                             |       | 3/4   | 301155   | B-913-6            |
|                             |       | 1     | 301156   | B-913-8            |
|                             |       | 1-1/4 | 301157   | B-913-10           |
|                             |       | 1-1/2 | 301158   | B-913-12           |
| .565                        | .815  | 1/2   | 401175   | SS-1826-8          |
|                             |       | 3/4   | 401176   | SS-1826-12         |
|                             |       | 1     | 401177   | SS-1826-16         |
|                             |       | 1-1/4 | 401178   | SS-1826-20         |
|                             |       | 1-1/2 | 401179   | SS-1826-24         |
| <b>9/16 X 7/8 NOMINAL</b>   |       |       |          |                    |
| .567                        | .877  | 1     | 101292   | AA-863-3           |
|                             |       | 1-3/8 | 101293   | AA-863             |

| ID                         | OD   | LGTH. | ITEM NO. | PART NO.           |
|----------------------------|------|-------|----------|--------------------|
| <b>5/8 X 3/4 NOMINAL</b>   |      |       |          |                    |
| .626                       | .753 | 1/2   | 101294   | AA-724-8           |
|                            |      | 7/8   | 101295   | AA-724-2           |
|                            |      | 1     | 101296   | AA-724-3           |
|                            |      | 1-1/8 | 101297   | AA-724             |
|                            |      | 1-1/4 | 101298   | AA-724-5           |
| .627                       | .752 | 1/2   | 101299   | AA-741             |
|                            |      | 5/8   | 101300   | AA-741-1           |
|                            |      | 3/4   | 101301   | AA-741-4           |
| .627                       | .753 | 3/8   | 101302   | AA-710-13          |
|                            |      | 1/2   | 101303   | AA-710-27          |
|                            |      | 5/8   | 101304   | AA-710-19          |
|                            |      | 3/4   | 101305   | AA-710-6           |
|                            |      | 7/8   | 101306   | AA-710-16          |
|                            |      | 1     | 101307   | AA-710-3           |
|                            |      | 1-1/8 | 101308   | AA-710-8           |
|                            |      | 1-1/4 | 101309   | AA-710-5           |
|                            |      | 1-1/2 | 101310   | AA-710-4           |
| .627                       | .753 | 3/8   | 201572   | EP101206 (P-62-3)  |
|                            |      | 1/2   | 201181   | EP101208 (P-62-4)  |
|                            |      | 5/8   | 201182   | EP101210 (P-62-5)  |
|                            |      | 3/4   | 201183   | EP101212 (P-62-6)  |
|                            |      | 7/8   | 201184   | EP101214 (P-62-7)  |
|                            |      | 1     | 201185   | EP101216 (P-62-8)  |
|                            |      | 1-1/8 | 201186   | EP101218 (P-62-9)  |
|                            |      | 1-1/4 | 201187   | EP101220 (P-62-10) |
|                            |      | 1-1/2 | 201188   | EP101224 (P-62-12) |
| .627                       | .753 | 1/2   | 301159   | B-1012-4           |
|                            |      | 5/8   | 301160   | B-1012-5           |
|                            |      | 3/4   | 301161   | B-1012-6           |
|                            |      | 7/8   | 301162   | B-1012-7           |
|                            |      | 1     | 301163   | B-1012-8           |
|                            |      | 1-1/8 | 301164   | B-1012-9           |
|                            |      | 1-1/4 | 301165   | B-1012-10          |
|                            |      | 1-1/2 | 301166   | B-1012-12          |
| .628                       | .753 | 1/2   | 401180   | SS-2024-8          |
|                            |      | 5/8   | 401181   | SS-2024-10         |
|                            |      | 3/4   | 401182   | SS-2024-12         |
|                            |      | 7/8   | 401183   | SS-2024-14         |
|                            |      | 1     | 401184   | SS-2024-16         |
|                            |      | 1-1/8 | 401185   | SS-2024-18         |
|                            |      | 1-1/4 | 401186   | SS-2024-20         |
|                            |      | 1-1/2 | 401187   | SS-2024-24         |
| <b>5/8 X 13/16 NOMINAL</b> |      |       |          |                    |
| .625                       | .815 | 1/2   | 101311   | AA-810-4           |
|                            |      | 5/8   | 101312   | AA-810-2           |
|                            |      | 3/4   | 101313   | AA-810-10          |
|                            |      | 7/8   | 101314   | AA-810-1           |
|                            |      | 1     | 101315   | AA-810-7           |
|                            |      | 1-1/4 | 101316   | AA-810-11          |
|                            |      | 1-3/8 | 101317   | AA-810             |
|                            |      | 1-1/2 | 101318   | AA-810-12          |
| .627                       | .815 | 3/4   | 101319   | AA-811-7           |
|                            |      | 1     | 101320   | AA-811-6           |

\*Other sizes, tolerances, lubricants and materials are available on special orders.





| ID                                 | OD    | LGTH. | ITEM NO. | PART NO.           | ID                     | OD    | LGTH.                      | ITEM NO. | PART NO.           | ID                           | OD     | LGTH. | ITEM NO. | PART NO.           |        |                   |
|------------------------------------|-------|-------|----------|--------------------|------------------------|-------|----------------------------|----------|--------------------|------------------------------|--------|-------|----------|--------------------|--------|-------------------|
| <b>5/8 X 13/16 NOMINAL (cont.)</b> |       |       |          |                    |                        |       |                            |          |                    |                              |        |       |          |                    |        |                   |
| .627                               | .815  | 1-1/4 | 101321   | AA-811-2           | .627                   | .878  | 5/8                        | 301175   | B-1014-5           | .628                         | 1.003  | 7/8   | 301186   | B-1016-7           |        |                   |
|                                    |       | 1-3/8 | 101322   | AA-811-5           |                        |       | 3/4                        | 301176   | B-1014-6           |                              |        | 1     | 301187   | B-1016-8           |        |                   |
|                                    |       | 1-1/2 | 101323   | AA-811-3           |                        |       | 7/8                        | 301177   | B-1014-7           |                              |        | 1-1/4 | 301188   | B-1016-10          |        |                   |
|                                    |       | 1-3/4 | 101324   | AA-811-1           |                        |       | 1                          | 301178   | B-1014-8           |                              |        | 1-1/2 | 301189   | B-1016-12          |        |                   |
|                                    |       | 1.99  | 101325   | AA-811             |                        |       | 1-1/4                      | 301179   | B-1014-10          |                              |        | 1-3/4 | 301190   | B-1016-14          |        |                   |
| .627                               | .815  | 1/2   | 301167   | B-1013-4           |                        |       | 1-1/2                      | 301180   | B-1014-12          |                              |        | 2     | 301191   | B-1016-16          |        |                   |
|                                    |       | 5/8   | 301168   | B-1013-5           |                        |       | 1-3/4                      | 301181   | B-1014-14          | .628                         | 1.003  | 1/2   | 401209   | SS-2032-8          |        |                   |
|                                    |       | 3/4   | 301169   | B-1013-6           | .627                   | .879  | 1/2                        | 201197   | EP101408 (P-64-4)  |                              |        | 5/8   | 401210   | SS-2032-10         |        |                   |
|                                    |       | 7/8   | 301170   | B-1013-7           |                        |       | 5/8                        | 201198   | EP101410 (P-64-5)  |                              |        | 3/4   | 401211   | SS-2032-12         |        |                   |
|                                    |       | 1     | 301171   | B-1013-8           |                        |       | 3/4                        | 201199   | EP101412 (P-64-6)  |                              |        | 7/8   | 401212   | SS-2032-14         |        |                   |
|                                    |       | 1-1/4 | 301172   | B-1013-10          |                        |       | 7/8                        | 201200   | EP101414 (P-64-7)  |                              |        | 1     | 401213   | SS-2032-16         |        |                   |
|                                    |       | 1-1/2 | 301173   | B-1013-12          |                        |       | 1                          | 201201   | EP101416 (P-64-8)  |                              |        | 1-1/4 | 401214   | SS-2032-20         |        |                   |
|                                    |       | 2     | 301174   | B-1013-16          |                        |       | 1-1/8                      | 201202   | EP101418 (P-64-9)  |                              |        | 1-1/2 | 401215   | SS-2032-24         |        |                   |
| .627                               | .8165 | 1/2   | 201189   | EP101308 (P-63-4)  |                        |       | 1-1/4                      | 201203   | EP101420 (P-64-10) |                              |        | 1-3/4 | 401216   | SS-2032-28         |        |                   |
|                                    |       | 5/8   | 201190   | EP101310 (P-63-5)  |                        |       | 1-1/2                      | 201204   | EP101424 (P-64-12) |                              |        | 2     | 401217   | SS-2032-32         |        |                   |
|                                    |       | 3/4   | 201191   | EP101312 (P-63-6)  |                        |       | 1-3/4                      | 201205   | EP101428 (P-64-14) | .628                         | 1.0035 | 3/4   | 101348   | AA-1011-12         |        |                   |
|                                    |       | 7/8   | 201192   | EP101314 (P-63-7)  |                        |       | 2                          | 201206   | EP101432 (P-64-16) |                              |        | 7/8   | 101349   | AA-1011-5          |        |                   |
|                                    |       | 1     | 201193   | EP101316 (P-63-8)  | .628                   | .878  | 1/2                        | 401196   | SS-2028-8          |                              |        | 1     | 101350   | AA-1011-3          |        |                   |
|                                    |       | 1-1/4 | 201194   | EP101320 (P-63-10) |                        |       | 5/8                        | 401197   | SS-2028-10         |                              |        | 1-1/8 | 101351   | AA-1011-4          |        |                   |
|                                    |       | 1-1/2 | 201195   | EP101324 (P-63-12) |                        |       | 3/4                        | 401198   | SS-2028-12         |                              |        | 1-1/4 | 101352   | AA-1011-1          |        |                   |
|                                    |       | 1-3/4 | 201196   | EP101328 (P-63-14) |                        |       | 7/8                        | 401199   | SS-2028-14         |                              |        | 1-3/8 | 101353   | AA-1011-13         |        |                   |
| .628                               | .815  | 1/2   | 401188   | SS-2026-8          |                        |       | 1                          | 401200   | SS-2028-16         |                              |        | 1-1/2 | 101354   | AA-1011            |        |                   |
|                                    |       | 5/8   | 401189   | SS-2026-10         |                        |       | 1-1/8                      | 401201   | SS-2028-18         | <b>11/16 X 13/16 NOMINAL</b> |        |       |          |                    |        |                   |
|                                    |       | 3/4   | 401190   | SS-2026-12         |                        |       | 1-1/4                      | 401202   | SS-2028-20         | .6885                        | .815   | 1     | 101355   | AA-812-1           |        |                   |
|                                    |       | 7/8   | 401191   | SS-2026-14         |                        |       | 1-1/2                      | 401203   | SS-2028-24         |                              |        | 1-1/4 | 101356   | AA-812             |        |                   |
|                                    |       | 1     | 401192   | SS-2026-16         |                        |       | 1-3/4                      | 401204   | SS-2028-28         | <b>11/16 X 7/8 NOMINAL</b>   |        |       |          |                    |        |                   |
|                                    |       | 1-1/4 | 401193   | SS-2026-20         |                        |       | 2                          | 401205   | SS-2028-32         | .6895                        | .879   | 3/4   | 201219   | EP111412 (P-68-6)  |        |                   |
|                                    |       | 1-1/2 | 401194   | SS-2026-24         |                        |       | <b>5/8 X 15/16 NOMINAL</b> |          |                    |                              |        |       |          | 1                  | 201220 | EP111416 (P-68-8) |
|                                    |       | 1-3/4 | 401195   | SS-2026-28         | .627                   | .9415 | 5/8                        | 201207   | EP101510 (P-65-5)  |                              |        | 1-1/4 | 201221   | EP111420 (P-68-10) |        |                   |
| .628                               | .8155 | 5/8   | 101326   | AA-814-3           |                        |       | 3/4                        | 201208   | EP101512 (P-65-6)  |                              |        | 1-1/2 | 201222   | EP111424 (P-68-12) |        |                   |
|                                    |       | 3/4   | 101327   | AA-814-2           |                        |       | 1                          | 201209   | EP101516 (P-65-8)  |                              |        | 1-3/4 | 201223   | EP111428 (P-68-14) |        |                   |
|                                    |       | 1     | 101328   | AA-814             | .628                   | .940  | 5/8                        | 101345   | AA-946-4           |                              |        | 2     | 201224   | EP111432 (P-68-16) |        |                   |
|                                    |       | 1-1/4 | 101329   | AA-814-5           |                        |       | 3/4                        | 101346   | AA-946-2           | .690                         | .878   | 1/2   | 101357   | AA-851-2           |        |                   |
| <b>5/8 X 7/8 NOMINAL</b>           |       |       |          |                    |                        |       | 1                          | 101347   | AA-946-1           |                              |        | 3/4   | 101358   | AA-851-7           |        |                   |
| .625                               | .877  | 1/2   | 101330   | AA-880-4           | .628                   | .941  | 5/8                        | 401206   | SS-2030-10         |                              |        | 1     | 101359   | AA-851-8           |        |                   |
|                                    |       | 3/4   | 101331   | AA-880-2           |                        |       | 3/4                        | 401207   | SS-2030-12         |                              |        | 1-1/8 | 101360   | AA-851-6           |        |                   |
|                                    |       | 1     | 101332   | AA-880-1           |                        |       | 1                          | 401208   | SS-2030-16         |                              |        | 1-1/4 | 101361   | AA-851-1           |        |                   |
|                                    |       | 1-1/2 | 101333   | AA-880             | <b>5/8 X 1 NOMINAL</b> |       |                            |          |                    | .690                         | .878   | 3/4   | 301192   | B-1114-6           |        |                   |
| .627                               | .878  | 1/2   | 101334   | AA-832-11          | .627                   | 1.004 | 1/2                        | 201210   | EP101608 (P-66-4)  |                              |        | 1     | 301193   | B-1114-8           |        |                   |
|                                    |       | 5/8   | 101335   | AA-832-12          |                        |       | 5/8                        | 201211   | EP101610 (P-66-5)  |                              |        | 1-1/4 | 301194   | B-1114-10          |        |                   |
|                                    |       | 3/4   | 101336   | AA-832-6           |                        |       | 3/4                        | 201212   | EP101612 (P-66-6)  |                              |        | 1-1/2 | 301195   | B-1114-12          |        |                   |
|                                    |       | 7/8   | 101337   | AA-832-8           |                        |       | 7/8                        | 201213   | EP101614 (P-66-7)  |                              |        | 1-3/4 | 301196   | B-1114-14          |        |                   |
|                                    |       | 1     | 101338   | AA-832-1           |                        |       | 1                          | 201214   | EP101616 (P-66-8)  |                              |        | 2     | 301197   | B-1114-16          |        |                   |
|                                    |       | 1-1/8 | 101339   | AA-832-13          |                        |       | 1-1/4                      | 201215   | EP101620 (P-66-10) | .690                         | .878   | 3/4   | 401218   | SS-2228-12         |        |                   |
|                                    |       | 1-1/4 | 101340   | AA-832-4           |                        |       | 1-1/2                      | 201216   | EP101624 (P-66-12) |                              |        | 1     | 401219   | SS-2228-16         |        |                   |
|                                    |       | 1-3/8 | 101341   | AA-832-2           |                        |       | 1-3/4                      | 201217   | EP101628 (P-66-14) |                              |        | 1-1/4 | 401220   | SS-2228-20         |        |                   |
|                                    |       | 1-1/2 | 101342   | AA-832-5           |                        |       | 2                          | 201218   | EP101632 (P-66-16) |                              |        | 1-1/2 | 401221   | SS-2228-24         |        |                   |
|                                    |       | 1-5/8 | 101343   | AA-832-9           | .628                   | 1.003 | 1/2                        | 301183   | B-1016-4           |                              |        | 1-3/4 | 401222   | SS-2228-28         |        |                   |
|                                    |       | 2     | 101344   | AA-832-18          |                        |       | 5/8                        | 301184   | B-1016-5           |                              |        | 2     | 401223   | SS-2228-32         |        |                   |
|                                    |       |       |          |                    |                        |       | 3/4                        | 301185   | B-1016-6           |                              |        |       |          |                    |        |                   |

\*Other sizes, tolerances, lubricants and materials are available on special orders.



| ID                           | OD   | LGTH. | ITEM NO. | PART NO.            |
|------------------------------|------|-------|----------|---------------------|
| <b>11/16 X 15/16 NOMINAL</b> |      |       |          |                     |
| .689                         | .941 | 1     | 101362   | AA-939-3            |
|                              |      | 1-1/4 | 101363   | AA-939-2            |
|                              |      | 1-1/2 | 101364   | AA-939-4            |
| <b>3/4 X 7/8 NOMINAL</b>     |      |       |          |                     |
| .751                         | .878 | 9/16  | 101365   | AA-838-9            |
|                              |      | 5/8   | 101366   | AA-838-25           |
|                              |      | 3/4   | 101367   | AA-838-16           |
|                              |      | 7/8   | 101368   | AA-838-6            |
|                              |      | 1     | 101369   | AA-838-7            |
|                              |      | 1-1/8 | 101370   | AA-838-13           |
|                              |      | 1-1/4 | 101371   | AA-838-5            |
|                              |      | 1-3/8 | 101372   | AA-838-15           |
|                              |      | 1-1/2 | 101373   | AA-838-4            |
|                              |      | 1-5/8 | 101374   | AA-838-8            |
| .752                         | .878 | 3/4   | 101375   | AA-885              |
|                              |      | 1     | 101376   | AA-885-3            |
|                              |      | 1-1/4 | 101377   | AA-885-4            |
| .752                         | .879 | 1/2   | 201225   | EP121408 (P-75-4)   |
|                              |      | 9/16  | 201573   | EP121409 (P-75-4.5) |
|                              |      | 5/8   | 201226   | EP121410 (P-75-5)   |
|                              |      | 11/16 | 201574   | EP121411 (P-75-5.5) |
|                              |      | 3/4   | 201227   | EP121412 (P-75-6)   |
|                              |      | 7/8   | 201228   | EP121414 (P-75-7)   |
|                              |      | 1     | 201229   | EP121416 (P-75-8)   |
|                              |      | 1-1/8 | 201230   | EP121418 (P-75-9)   |
|                              |      | 1-1/4 | 201231   | EP121420 (P-75-10)  |
|                              |      | 1-1/2 | 201232   | EP121424 (P-75-12)  |
|                              |      | 1-5/8 | 201233   | EP121426 (P-75-13)  |
| .753                         | .878 | 5/8   | 101378   | AA-839-1            |
|                              |      | 11/16 | 101379   | AA-839-3            |
|                              |      | 3/4   | 101380   | AA-839-6            |
|                              |      | 1     | 101381   | AA-839-13           |
|                              |      | 1-1/8 | 101382   | AA-839-2            |
|                              |      | 1-1/4 | 101383   | AA-839-4            |
|                              |      | 1-1/2 | 101384   | AA-839-7            |
| .753                         | .878 | 1/2   | 301198   | B-1214-4            |
|                              |      | 5/8   | 301199   | B-1214-5            |
|                              |      | 3/4   | 301200   | B-1214-6            |
|                              |      | 7/8   | 301201   | B-1214-7            |
|                              |      | 1     | 301202   | B-1214-8            |
|                              |      | 1-1/4 | 301203   | B-1214-10           |
|                              |      | 1-1/2 | 301204   | B-1214-12           |
|                              |      | 1-5/8 | 301205   | B-1214-13           |
| .753                         | .878 | 1/2   | 401224   | SS-2428-8           |
|                              |      | 5/8   | 401225   | SS-2428-10          |
|                              |      | 3/4   | 401226   | SS-2428-12          |
|                              |      | 7/8   | 401227   | SS-2428-14          |
|                              |      | 1     | 401228   | SS-2428-16          |
|                              |      | 1-1/8 | 401229   | SS-2428-18          |
|                              |      | 1-1/4 | 401230   | SS-2428-20          |
|                              |      | 1-1/2 | 401231   | SS-2428-24          |
|                              |      | 1-5/8 | 401232   | SS-2428-26          |

| ID                         | OD     | LGTH. | ITEM NO. | PART NO.           |
|----------------------------|--------|-------|----------|--------------------|
| <b>3/4 X 15/16 NOMINAL</b> |        |       |          |                    |
| .7515                      | .940   | 3/4   | 101385   | AA-921-5           |
|                            |        | 1     | 101386   | AA-921-4           |
|                            |        | 1-1/8 | 101387   | AA-921-2           |
|                            |        | 1-1/4 | 101388   | AA-921-3           |
|                            |        | 1-1/2 | 101389   | AA-921-1           |
|                            |        | 1-3/4 | 101390   | AA-921             |
|                            |        | 2     | 101391   | AA-921-6           |
| .752                       | .9415  | 1/2   | 201234   | EP121508 (P-76-4)  |
|                            |        | 5/8   | 201235   | EP121510 (P-76-5)  |
|                            |        | 3/4   | 201236   | EP121512 (P-76-6)  |
|                            |        | 7/8   | 201237   | EP121514 (P-76-7)  |
|                            |        | 1     | 201238   | EP121516 (P-76-8)  |
|                            |        | 1-1/8 | 201239   | EP121518 (P-76-9)  |
|                            |        | 1-1/4 | 201240   | EP121520 (P-76-10) |
|                            |        | 1-1/2 | 201241   | EP121524 (P-76-12) |
|                            |        | 1-5/8 | 201242   | EP121526 (P-76-13) |
|                            |        | 1-3/4 | 201243   | EP121528 (P-76-14) |
|                            |        | 1-7/8 | 201244   | EP121530 (P-76-15) |
|                            |        | 2     | 201245   | EP121532 (P-76-16) |
| .752                       | .942   | 1     | 101392   | AA-912             |
|                            |        | 1-1/4 | 101393   | AA-912-4           |
|                            |        | 1-3/8 | 101394   | AA-912-1           |
|                            |        | 1-1/2 | 101395   | AA-912-6           |
|                            |        | 1-5/8 | 101396   | AA-912-2           |
|                            |        | 1-3/4 | 101397   | AA-912-7           |
| .753                       | .9405  | 1/2   | 301206   | B-1215-4           |
|                            |        | 5/8   | 301207   | B-1215-5           |
|                            |        | 3/4   | 301208   | B-1215-6           |
|                            |        | 7/8   | 301209   | B-1215-7           |
|                            |        | 1     | 301210   | B-1215-8           |
|                            |        | 1-1/4 | 301211   | B-1215-10          |
|                            |        | 1-1/2 | 301212   | B-1215-12          |
|                            |        | 1-3/4 | 301213   | B-1215-14          |
|                            |        | 2     | 301214   | B-1215-16          |
| .753                       | .941   | 1/2   | 401233   | SS-2430-8          |
|                            |        | 5/8   | 401234   | SS-2430-10         |
|                            |        | 3/4   | 401235   | SS-2430-12         |
|                            |        | 7/8   | 401236   | SS-2430-14         |
|                            |        | 1     | 401237   | SS-2430-16         |
|                            |        | 1-1/8 | 401238   | SS-2430-18         |
|                            |        | 1-1/4 | 401239   | SS-2430-20         |
|                            |        | 1-1/2 | 401240   | SS-2430-24         |
|                            |        | 1-5/8 | 401241   | SS-2430-26         |
|                            |        | 1-3/4 | 401242   | SS-2430-28         |
|                            |        | 1-7/8 | 401243   | SS-2430-30         |
|                            |        | 2     | 401244   | SS-2430-32         |
| <b>3/4 X 1 NOMINAL</b>     |        |       |          |                    |
| .7505                      | 1.0025 | 3/4   | 101398   | AA-1005-5          |
|                            |        | 1     | 101399   | AA-1005-7          |
|                            |        | 1-1/8 | 101400   | AA-1005-3          |

| ID    | OD     | LGTH. | ITEM NO. | PART NO.           |
|-------|--------|-------|----------|--------------------|
| .7505 | 1.0025 | 1-1/4 | 101401   | AA-1005-2          |
|       |        | 1-1/2 | 101402   | AA-1005-4          |
| .752  | 1.0025 | 3/8   | 101403   | AA-1049-18         |
|       |        | 1/2   | 101404   | AA-1049-14         |
|       |        | 3/4   | 101405   | AA-1049-1          |
|       |        | 7/8   | 101406   | AA-1049-2          |
|       |        | 1     | 101407   | AA-1049-3          |
|       |        | 1-1/8 | 101408   | AA-1049-16         |
|       |        | 1-1/4 | 101409   | AA-1049            |
|       |        | 1-3/8 | 101410   | AA-1049-17         |
|       |        | 1-1/2 | 101411   | AA-1049-4          |
|       |        | 1-3/4 | 101412   | AA-1049-9          |
|       |        | 2     | 101413   | AA-1049-5          |
|       |        | 2-1/8 | 101414   | AA-1049-11         |
|       |        | 2-1/4 | 101415   | AA-1049-12         |
|       |        | 2-1/2 | 101416   | AA-1049-6          |
| .752  | 1.004  | 1/2   | 201246   | EP121608 (P-77-4)  |
|       |        | 5/8   | 201247   | EP121610 (P-77-5)  |
|       |        | 3/4   | 201248   | EP121612 (P-77-6)  |
|       |        | 7/8   | 201249   | EP121614 (P-77-7)  |
|       |        | 1     | 201250   | EP121616 (P-77-8)  |
|       |        | 1-1/8 | 201251   | EP121618 (P-77-9)  |
|       |        | 1-1/4 | 201252   | EP121620 (P-77-10) |
|       |        | 1-1/2 | 201253   | EP121624 (P-77-12) |
|       |        | 1-3/4 | 201254   | EP121628 (P-77-14) |
|       |        | 2     | 201255   | EP121632 (P-77-16) |
|       |        | 2-1/2 | 201256   | EP121640 (P-77-20) |
| .753  | 1.003  | 3/4   | 101417   | AA-1043-6          |
|       |        | 7/8   | 101418   | AA-1043-8          |
|       |        | 1     | 101419   | AA-1043-9          |
|       |        | 1-1/4 | 101420   | AA-1043            |
|       |        | 1-1/2 | 101421   | AA-1043-4          |
| .753  | 1.003  | 1/2   | 301215   | B-1216-4           |
|       |        | 5/8   | 301216   | B-1216-5           |
|       |        | 3/4   | 301217   | B-1216-6           |
|       |        | 7/8   | 301218   | B-1216-7           |
|       |        | 1     | 301219   | B-1216-8           |
|       |        | 1-1/8 | 301220   | B-1216-9           |
|       |        | 1-1/4 | 301221   | B-1216-10          |
|       |        | 1-1/2 | 301222   | B-1216-12          |
|       |        | 1-3/4 | 301223   | B-1216-14          |
|       |        | 2     | 301224   | B-1216-16          |
|       |        | 2-1/2 | 301225   | B-1216-20          |
| .753  | 1.003  | 1/2   | 401245   | SS-2432-8          |
|       |        | 5/8   | 401246   | SS-2432-10         |
|       |        | 3/4   | 401247   | SS-2432-12         |
|       |        | 7/8   | 401248   | SS-2432-14         |
|       |        | 1     | 401249   | SS-2432-16         |
|       |        | 1-1/8 | 401250   | SS-2432-18         |
|       |        | 1-1/4 | 401251   | SS-2432-20         |
|       |        | 1-1/2 | 401252   | SS-2432-24         |
|       |        | 1-3/4 | 401253   | SS-2432-28         |
|       |        | 2     | 401254   | SS-2432-32         |
|       |        | 2-1/2 | 401255   | SS-2432-40         |

\*Other sizes, tolerances, lubricants and materials are available on special orders.



| ID                          | OD     | LGTH. | ITEM NO. | PART NO.           |
|-----------------------------|--------|-------|----------|--------------------|
| <b>3/4 X 1-1/16 NOMINAL</b> |        |       |          |                    |
| .751                        | 1.0645 | 1     | 101422   | AA-1039            |
|                             |        | 1-1/4 | 101423   | AA-1039-2          |
| <b>3/4 X 1-1/8 NOMINAL</b>  |        |       |          |                    |
| .750                        | 1.129  | 3/4   | 101424   | AA-1130-3          |
|                             |        | 1-1/4 | 101425   | AA-1130            |
| .752                        | 1.129  | 1/2   | 201257   | EP121808 (P-78-4)  |
|                             |        | 3/4   | 201258   | EP121812 (P-78-6)  |
|                             |        | 1     | 201259   | EP121816 (P-78-8)  |
|                             |        | 1-1/4 | 201260   | EP121820 (P-78-10) |
|                             |        | 1-1/2 | 201261   | EP121824 (P-78-12) |
|                             |        | 1-3/4 | 201262   | EP121828 (P-78-14) |
|                             |        | 2     | 201263   | EP121832 (P-78-16) |
| .753                        | 1.128  | 3/4   | 101426   | AA-1106-2          |
|                             |        | 1     | 101427   | AA-1106-4          |
|                             |        | 1-1/4 | 101428   | AA-1106-3          |
|                             |        | 1-3/8 | 101429   | AA-1106-13         |
|                             |        | 1-1/2 | 101430   | AA-1106            |
|                             |        | 1-3/4 | 101431   | AA-1106-1          |
| .753                        | 1.128  | 1/2   | 301226   | B-1218-4           |
|                             |        | 3/4   | 301227   | B-1218-6           |
|                             |        | 1     | 301228   | B-1218-8           |
|                             |        | 1-1/4 | 301229   | B-1218-10          |
|                             |        | 1-1/2 | 301230   | B-1218-12          |
|                             |        | 1-3/4 | 301231   | B-1218-14          |
|                             |        | 2     | 301232   | B-1218-16          |
| .753                        | 1.128  | 1/2   | 401256   | SS-2436-8          |
|                             |        | 3/4   | 401257   | SS-2436-12         |
|                             |        | 1     | 401258   | SS-2436-16         |
|                             |        | 1-1/4 | 401259   | SS-2436-20         |
|                             |        | 1-1/2 | 401260   | SS-2436-24         |
|                             |        | 1-3/4 | 401261   | SS-2436-28         |
|                             |        | 2     | 401262   | SS-2436-32         |
| <b>3/4 X 1-1/4 NOMINAL</b>  |        |       |          |                    |
| .752                        | 1.254  | 3/4   | 201264   | EP122012 (P-79-6)  |
|                             |        | 1     | 201265   | EP122016 (P-79-8)  |
|                             |        | 1-1/4 | 201266   | EP122020 (P-79-10) |
|                             |        | 1-1/2 | 201267   | EP122024 (P-79-12) |
| .753                        | 1.253  | 1     | 101432   | AA-1257            |
|                             |        | 1-1/4 | 101433   | AA-1257-1          |
|                             |        | 1-1/2 | 101434   | AA-1257-2          |
| .753                        | 1.253  | 3/4   | 301233   | B-1220-6           |
|                             |        | 1     | 301234   | B-1220-8           |
|                             |        | 1-1/4 | 301235   | B-1220-10          |
|                             |        | 1-1/2 | 301236   | B-1220-12          |
|                             |        | 1-3/4 | 301237   | B-1220-14          |
|                             |        | 2     | 301238   | B-1220-16          |
| .753                        | 1.253  | 3/4   | 401263   | SS-2440-12         |
|                             |        | 1     | 401264   | SS-2440-16         |
|                             |        | 1-1/4 | 401265   | SS-2440-20         |
|                             |        | 1-1/2 | 401266   | SS-2440-24         |

| ID                       | OD    | LGTH. | ITEM NO. | PART NO.           |
|--------------------------|-------|-------|----------|--------------------|
| <b>13/16 X 1 NOMINAL</b> |       |       |          |                    |
| .8135                    | 1.003 | 1     | 101435   | AA-1056-5          |
|                          |       | 1-1/4 | 101436   | AA-1056-3          |
|                          |       | 1-3/4 | 101437   | AA-1056            |
| .8145                    | 1.003 | 7/8   | 101438   | AA-1041-2          |
|                          |       | 1     | 101439   | AA-1041-5          |
|                          |       | 1-1/4 | 101440   | AA-1041-6          |
| .8145                    | 1.004 | 3/4   | 201268   | EP131612 (P-81-6)  |
|                          |       | 1     | 201269   | EP131616 (P-81-8)  |
|                          |       | 1-1/4 | 201270   | EP131620 (P-81-10) |
|                          |       | 1-1/2 | 201271   | EP131624 (P-81-12) |
|                          |       | 1-3/4 | 201272   | EP131628 (P-81-14) |
| .815                     | 1.003 | 3/4   | 401267   | SS-2632-12         |
|                          |       | 1     | 401268   | SS-2632-16         |
|                          |       | 1-1/4 | 401269   | SS-2632-20         |
|                          |       | 1-1/2 | 401270   | SS-2632-24         |
|                          |       | 1-3/4 | 401271   | SS-2632-28         |
|                          |       | 2     | 401272   | SS-2632-32         |
| .8155                    | 1.003 | 3/4   | 301239   | B-1316-6           |
|                          |       | 1     | 301240   | B-1316-8           |
|                          |       | 1-1/4 | 301241   | B-1316-10          |
|                          |       | 1-1/2 | 301242   | B-1316-12          |
|                          |       | 1-3/4 | 301243   | B-1316-14          |
|                          |       | 2     | 301244   | B-1316-16          |
| <b>7/8 X 1 NOMINAL</b>   |       |       |          |                    |
| .876                     | 1.003 | 3/8   | 101441   | AA-1008-11         |
|                          |       | 7/16  | 101442   | AA-1008-14         |
|                          |       | 1/2   | 101443   | AA-1008-9          |
|                          |       | 5/8   | 101444   | AA-1008-13         |
|                          |       | 3/4   | 101445   | AA-1008-5          |
|                          |       | 1     | 101446   | AA-1008-6          |
|                          |       | 1-1/4 | 101447   | AA-1008-1          |
|                          |       | 1-1/2 | 101448   | AA-1008-2          |
|                          |       | 1-3/4 | 101449   | AA-1008-10         |
| .877                     | 1.003 | 5/8   | 101450   | AA-1009-5          |
|                          |       | 3/4   | 101451   | AA-1009-8          |
|                          |       | 1     | 101452   | AA-1009-3          |
|                          |       | 1-1/8 | 101453   | AA-1009            |
|                          |       | 1-1/4 | 101454   | AA-1009-2          |
| .877                     | 1.004 | 3/8   | 201575   | EP141606 (P-87-3)  |
|                          |       | 1/2   | 201576   | EP141608 (P-87-4)  |
|                          |       | 5/8   | 201577   | EP141610 (P-87-5)  |
|                          |       | 3/4   | 201275   | EP141612 (P-87-6)  |
|                          |       | 7/8   | 201276   | EP141614 (P-87-7)  |
|                          |       | 1     | 201277   | EP141616 (P-87-8)  |
|                          |       | 1-1/4 | 201278   | EP141620 (P-87-10) |
| .877                     | 1.004 | 1-1/2 | 201279   | EP141624 (P-87-12) |
|                          |       | 1-3/4 | 201280   | EP141628 (P-87-14) |
| .878                     | 1.003 | 3/4   | 301245   | B-1416-6           |
|                          |       | 7/8   | 301246   | B-1416-7           |
|                          |       | 1     | 301247   | B-1416-8           |
|                          |       | 1-1/4 | 301248   | B-1416-10          |

| ID                          | OD     | LGTH. | ITEM NO. | PART NO.           |
|-----------------------------|--------|-------|----------|--------------------|
|                             |        | 1-1/2 | 301249   | B-1416-12          |
| .878                        | 1.003  | 1/2   | 401275   | SS-2832-8          |
|                             |        | 3/4   | 401276   | SS-2832-12         |
|                             |        | 7/8   | 401277   | SS-2832-14         |
|                             |        | 1     | 401278   | SS-2832-16         |
|                             |        | 1-1/4 | 401279   | SS-2832-20         |
|                             |        | 1-1/2 | 401280   | SS-2832-24         |
|                             |        | 1-3/4 | 401281   | SS-2832-28         |
| <b>7/8 X 1-1/16 NOMINAL</b> |        |       |          |                    |
| .877                        | 1.065  | 3/4   | 101455   | AA-1051-3          |
|                             |        | 1-1/4 | 101456   | AA-1051-2          |
| .877                        | 1.0665 | 1     | 201281   | EP141716 (P-88-8)  |
|                             |        | 1-1/4 | 201282   | EP141720 (P-88-10) |
|                             |        | 1-1/2 | 201283   | EP141724 (P-88-12) |
| .878                        | 1.0655 | 1     | 401282   | SS-2834-16         |
|                             |        | 1-1/4 | 401283   | SS-2834-20         |
| <b>7/8 X 1-1/8 NOMINAL</b>  |        |       |          |                    |
| .876                        | 1.128  | 3/4   | 101457   | AA-1108            |
|                             |        | 7/8   | 101458   | AA-1108-15         |
|                             |        | 1     | 101459   | AA-1108-1          |
|                             |        | 1-1/8 | 101460   | AA-1108-2          |
|                             |        | 1-1/4 | 101461   | AA-1108-7          |
|                             |        | 1-3/8 | 101462   | AA-1108-16         |
|                             |        | 1-1/2 | 101463   | AA-1108-12         |
|                             |        | 1-3/4 | 101464   | AA-1108-10         |
|                             |        | 2     | 101465   | AA-1108-3          |
|                             |        | 2-1/4 | 101466   | AA-1108-11         |
|                             |        | 2-1/2 | 101467   | AA-1108-5          |
|                             |        | 2-3/4 | 101468   | AA-1108-6          |
| .877                        | 1.129  | 3/4   | 201284   | EP141812 (P-89-6)  |
|                             |        | 7/8   | 201285   | EP141814 (P-89-7)  |
|                             |        | 1     | 201286   | EP141816 (P-89-8)  |
|                             |        | 1-1/8 | 201287   | EP141818 (P-89-9)  |
|                             |        | 1-1/4 | 201288   | EP141820 (P-89-10) |
|                             |        | 1-3/8 | 201289   | EP141822 (P-89-11) |
|                             |        | 1-1/2 | 201290   | EP141824 (P-89-12) |
|                             |        | 1-5/8 | 201291   | EP141826 (P-89-13) |
|                             |        | 1-3/4 | 201292   | EP141828 (P-89-14) |
|                             |        | 2     | 201293   | EP141832 (P-89-16) |
|                             |        | 2-1/4 | 201294   | EP141836 (P-89-18) |
|                             |        | 2-1/2 | 201295   | EP141840 (P-89-20) |
| .878                        | 1.1275 | 1     | 101469   | AA-1104-2          |
|                             |        | 1-1/4 | 101470   | AA-1104-5          |
|                             |        | 1-3/8 | 101471   | AA-1104-4          |
|                             |        | 1-1/2 | 101472   | AA-1104-3          |
| .878                        | 1.128  | 3/4   | 301250   | B-1418-6           |
|                             |        | 7/8   | 301251   | B-1418-7           |
|                             |        | 1     | 301252   | B-1418-8           |
|                             |        | 1-1/8 | 301253   | B-1418-9           |
|                             |        | 1-1/4 | 301254   | B-1418-10          |
|                             |        | 1-3/8 | 301255   | B-1418-11          |
|                             |        | 1-1/2 | 301256   | B-1418-12          |



| ID                                 | OD     | LGTH. | ITEM NO. | PART NO.           |
|------------------------------------|--------|-------|----------|--------------------|
| <b>7/8 X 1-1/8 NOMINAL (cont.)</b> |        |       |          |                    |
| .878                               | 1.128  | 1-3/4 | 301257   | B-1418-14          |
|                                    |        | 2     | 301258   | B-1418-16          |
|                                    |        | 2-1/2 | 301259   | B-1418-20          |
| .878                               | 1.128  | 3/4   | 401284   | SS-2836-12         |
|                                    |        | 7/8   | 401285   | SS-2836-14         |
|                                    |        | 1     | 401286   | SS-2836-16         |
|                                    |        | 1-1/8 | 401287   | SS-2836-18         |
|                                    |        | 1-1/4 | 401288   | SS-2836-20         |
|                                    |        | 1-3/8 | 401289   | SS-2836-22         |
|                                    |        | 1-1/2 | 401290   | SS-2836-24         |
|                                    |        | 1-5/8 | 401291   | SS-2836-26         |
|                                    |        | 1-3/4 | 401292   | SS-2836-28         |
|                                    |        | 2     | 401293   | SS-2836-32         |
|                                    |        | 2-1/4 | 401294   | SS-2836-36         |
|                                    |        | 2-1/2 | 401295   | SS-2836-40         |
| <b>7/8 X 1-1/4 NOMINAL</b>         |        |       |          |                    |
| .877                               | 1.252  | 1     | 101473   | AA-1203-3          |
|                                    |        | 1-1/4 | 101474   | AA-1203            |
|                                    |        | 1-1/2 | 101475   | AA-1203-1          |
| .877                               | 1.254  | 3/4   | 201296   | EP142012 (P-90-6)  |
|                                    |        | 1     | 201297   | EP142016 (P-90-8)  |
|                                    |        | 1-1/4 | 201298   | EP142020 (P-90-10) |
|                                    |        | 1-1/2 | 201299   | EP142024 (P-90-12) |
|                                    |        | 2     | 201300   | EP142032 (P-90-16) |
| .878                               | 1.253  | 3/4   | 101476   | AA-1242-2          |
|                                    |        | 1     | 101477   | AA-1242-3          |
|                                    |        | 1-3/8 | 101478   | AA-1242            |
| .878                               | 1.253  | 3/4   | 301260   | B-1420-6           |
|                                    |        | 1     | 301261   | B-1420-8           |
|                                    |        | 1-1/4 | 301262   | B-1420-10          |
|                                    |        | 1-1/2 | 301263   | B-1420-12          |
|                                    |        | 2     | 301264   | B-1420-16          |
| .878                               | 1.253  | 3/4   | 401296   | SS-2840-12         |
|                                    |        | 1     | 401297   | SS-2840-16         |
|                                    |        | 1-1/4 | 401298   | SS-2840-20         |
|                                    |        | 1-1/2 | 401299   | SS-2840-24         |
|                                    |        | 2     | 401300   | SS-2840-32         |
| <b>15/16 X 1-1/16 NOMINAL</b>      |        |       |          |                    |
| .940                               | 1.065  | 3/4   | 101479   | AA-1087-1          |
|                                    |        | 1-1/4 | 101480   | AA-1087            |
| <b>15/16 X 1-3/16 NOMINAL</b>      |        |       |          |                    |
| .939                               | 1.1895 | 7/8   | 101481   | AA-1118-6          |
|                                    |        | 1     | 101482   | AA-1118-4          |
|                                    |        | 1-1/4 | 101483   | AA-1118-2          |
|                                    |        | 1-1/2 | 101484   | AA-1118-5          |

| ID                           | OD     | LGTH. | ITEM NO. | PART NO.           |
|------------------------------|--------|-------|----------|--------------------|
| .9395                        | 1.1915 | 3/4   | 201301   | EP151912 (P-93-6)  |
|                              |        | 1     | 201302   | EP151916 (P-93-8)  |
|                              |        | 1-1/4 | 201303   | EP151920 (P-93-10) |
|                              |        | 1-1/2 | 201304   | EP151924 (P-93-12) |
|                              |        | 2     | 201305   | EP151932 (P-93-16) |
| .940                         | 1.190  | 3/4   | 401301   | SS-3038-12         |
|                              |        | 1     | 401302   | SS-3038-16         |
|                              |        | 1-1/4 | 401303   | SS-3038-20         |
|                              |        | 1-1/2 | 401304   | SS-3038-24         |
|                              |        | 2     | 401305   | SS-3038-32         |
| .9405                        | 1.1905 | 3/4   | 301265   | B-1519-6           |
|                              |        | 1     | 301266   | B-1519-8           |
|                              |        | 1-1/4 | 301267   | B-1519-10          |
|                              |        | 1-1/2 | 301268   | B-1519-12          |
|                              |        | 2     | 301269   | B-1519-16          |
| <b>15/16 X 1-1/4 NOMINAL</b> |        |       |          |                    |
| .9375                        | 1.253  | 1     | 101485   | AA-1206-1          |
|                              |        | 1-1/4 | 101486   | AA-1206-4          |
|                              |        | 1-1/2 | 101487   | AA-1206-2          |
| .9395                        | 1.254  | 3/4   | 201306   | EP152012 (P-94-6)  |
|                              |        | 1     | 201307   | EP152016 (P-94-8)  |
|                              |        | 1-1/4 | 201308   | EP152020 (P-94-10) |
|                              |        | 1-1/2 | 201309   | EP152024 (P-94-12) |
|                              |        | 1-3/4 | 201310   | EP152028 (P-94-14) |
|                              |        | 2     | 201311   | EP152032 (P-94-16) |
| .940                         | 1.254  | 1-1/2 | 101488   | AA-1216-3          |
|                              |        | 2     | 101489   | AA-1216            |
| .940                         | 1.254  | 3/4   | 401306   | SS-3040-12         |
|                              |        | 1     | 401307   | SS-3040-16         |
|                              |        | 1-1/4 | 401308   | SS-3040-20         |
|                              |        | 1-1/2 | 401309   | SS-3040-24         |
|                              |        | 1-3/4 | 401310   | SS-3040-28         |
|                              |        | 2     | 401311   | SS-3040-32         |
| .9405                        | 1.253  | 3/4   | 301270   | B-1520-6           |
|                              |        | 1     | 301271   | B-1520-8           |
|                              |        | 1-1/4 | 301272   | B-1520-10          |
|                              |        | 1-1/2 | 301273   | B-1520-12          |
|                              |        | 1-3/4 | 301274   | B-1520-14          |
|                              |        | 2     | 301275   | B-1520-16          |
| <b>1 X 1-1/8 NOMINAL</b>     |        |       |          |                    |
| 1.001                        | 1.128  | 1/2   | 101490   | AA-1110-8          |
|                              |        | 3/4   | 101491   | AA-1110-10         |
|                              |        | 13/16 | 101492   | AA-1110-2          |
|                              |        | 1     | 101493   | AA-1110-1          |
|                              |        | 1-1/4 | 101494   | AA-1110-3          |
|                              |        | 1-3/8 | 101495   | AA-1110-12         |
|                              |        | 1-1/2 | 101496   | AA-1110            |
| 1.003                        | 1.128  | 3/4   | 301276   | B-1618-6           |
|                              |        | 1     | 301277   | B-1618-8           |
|                              |        | 1-1/4 | 301278   | B-1618-10          |
|                              |        | 1-1/2 | 301279   | B-1618-12          |
|                              |        | 1-3/4 | 301280   | B-1618-14          |
|                              |        | 2     | 301281   | B-1618-16          |

| ID                        | OD     | LGTH. | ITEM NO. | PART NO.            |
|---------------------------|--------|-------|----------|---------------------|
| 1.003                     | 1.129  | 3/4   | 201312   | EP161812 (P-100-6)  |
|                           |        | 7/8   | 201578   | EP161814 (P-100-7)  |
|                           |        | 1     | 201313   | EP161816 (P-100-8)  |
|                           |        | 1-1/4 | 201314   | EP161820 (P-100-10) |
|                           |        | 1-1/2 | 201315   | EP161824 (P-100-12) |
|                           |        | 1-3/4 | 201316   | EP161828 (P-100-14) |
|                           |        | 2     | 201317   | EP161832 (P-100-16) |
| 1.0035                    | 1.128  | 3/4   | 101497   | AA-1156             |
|                           |        | 7/8   | 101498   | AA-1156-4           |
|                           |        | 1-1/4 | 101499   | AA-1156-3           |
|                           |        | 1-1/2 | 101500   | AA-1156-1           |
| 1.004                     | 1.128  | 3/4   | 401312   | SS-3236-12          |
|                           |        | 1     | 401313   | SS-3236-16          |
|                           |        | 1-1/4 | 401314   | SS-3236-20          |
|                           |        | 1-1/2 | 401315   | SS-3236-24          |
|                           |        | 1-3/4 | 401316   | SS-3236-28          |
|                           |        | 2     | 401317   | SS-3236-32          |
| <b>1 X 1-3/16 NOMINAL</b> |        |       |          |                     |
| 1.002                     | 1.1895 | 3/4   | 101501   | AA-1154-2           |
|                           |        | 1     | 101502   | AA-1154-1           |
|                           |        | 1-1/2 | 101503   | AA-1154-3           |
|                           |        | 2     | 101504   | AA-1154             |
| 1.003                     | 1.1915 | 3/4   | 201318   | EP161912 (P-101-6)  |
|                           |        | 1     | 201319   | EP161916 (P-101-8)  |
|                           |        | 1-1/4 | 201320   | EP161920 (P-101-10) |
|                           |        | 1-1/2 | 201321   | EP161924 (P-101-12) |
|                           |        | 1-3/4 | 201322   | EP161928 (P-101-14) |
|                           |        | 2     | 201323   | EP161932 (P-101-16) |
| 1.004                     | 1.190  | 3/4   | 401318   | SS-3238-12          |
|                           |        | 1     | 401319   | SS-3238-16          |
|                           |        | 1-1/4 | 401320   | SS-3238-20          |
|                           |        | 1-1/2 | 401321   | SS-3238-24          |
|                           |        | 1-3/4 | 401322   | SS-3238-28          |
|                           |        | 2     | 401323   | SS-3238-32          |
| <b>1 X 1-1/4 NOMINAL</b>  |        |       |          |                     |
| 1.001                     | 1.252  | 1/2   | 101505   | AA-1212-7           |
|                           |        | 3/4   | 101506   | AA-1212-6           |
|                           |        | 1     | 101507   | AA-1212-2           |
|                           |        | 1-1/4 | 101508   | AA-1212-16          |
|                           |        | 1-1/2 | 101509   | AA-1212-11          |
|                           |        | 1-3/4 | 101510   | AA-1212-4           |
|                           |        | 2     | 101511   | AA-1212-3           |
|                           |        | 2-1/4 | 101512   | AA-1212-5           |
|                           |        | 2-1/2 | 101513   | AA-1212             |
|                           |        | 2-7/8 | 101514   | AA-1212-8           |
|                           |        | 3     | 101515   | AA-1212-14          |
| 1.002                     | 1.252  | 7/8   | 101516   | AA-1213-6           |
|                           |        | 1     | 101517   | AA-1213-3           |
|                           |        | 1-1/8 | 101518   | AA-1213-10          |
|                           |        | 1-1/4 | 101519   | AA-1213-12          |
|                           |        | 1-1/2 | 101520   | AA-1213-1           |

\*Other sizes, tolerances, lubricants and materials are available on special orders.



| ID                               | OD     | LGTH.               | ITEM NO. | PART NO.            |
|----------------------------------|--------|---------------------|----------|---------------------|
| <b>1 X 1-1/4 NOMINAL (cont.)</b> |        |                     |          |                     |
| 1.002                            | 1.252  | 1-3/4               | 101521   | AA-1213-2           |
|                                  |        | 2                   | 101522   | AA-1213             |
|                                  |        | 2-1/2               | 101523   | AA-1213-14          |
|                                  |        | 3                   | 101524   | AA-1213-15          |
| 1.003                            | 1.253  | 3/4                 | 101525   | AA-1232-6           |
|                                  |        | 1                   | 101526   | AA-1232             |
|                                  |        | 1-1/8               | 101527   | AA-1232-2           |
|                                  |        | 1-1/4               | 101528   | AA-1232-3           |
|                                  |        | 1-1/2               | 101529   | AA-1232-7           |
|                                  |        | 1-3/4               | 101530   | AA-1232-8           |
|                                  |        | 2                   | 101531   | AA-1232-4           |
|                                  |        | 2-1/2               | 101532   | AA-1232-5           |
| 1.003                            | 1.253  | 3/4                 | 301282   | B-1620-6            |
|                                  |        | 7/8                 | 301283   | B-1620-7            |
|                                  |        | 1                   | 301284   | B-1620-8            |
|                                  |        | 1-1/4               | 301285   | B-1620-10           |
|                                  |        | 1-3/8               | 301286   | B-1620-11           |
|                                  |        | 1-1/2               | 301287   | B-1620-12           |
|                                  |        | 1-3/4               | 301288   | B-1620-14           |
|                                  |        | 2                   | 301289   | B-1620-16           |
|                                  |        | 2-1/4               | 301290   | B-1620-18           |
|                                  |        | 2-1/2               | 301291   | B-1620-20           |
|                                  |        | 3                   | 301292   | B-1620-24           |
| 1.003                            | 1.254  | 1/2                 | 201324   | EP162008 (P-102-4)  |
|                                  |        | 3/4                 | 201325   | EP162012 (P-102-6)  |
|                                  |        | 7/8                 | 201326   | EP162014 (P-102-7)  |
|                                  |        | 1                   | 201327   | EP162016 (P-102-8)  |
|                                  |        | 1-1/4               | 201328   | EP162020 (P-102-10) |
|                                  |        | 1-3/8               | 201329   | EP162022 (P-102-11) |
|                                  |        | 1-1/2               | 201330   | EP162024 (P-102-12) |
|                                  |        | 1-3/4               | 201331   | EP162028 (P-102-14) |
|                                  |        | 2                   | 201332   | EP162032 (P-102-16) |
|                                  |        | 2-1/4               | 201333   | EP162036 (P-102-18) |
|                                  |        | 2-1/2               | 201334   | EP162040 (P-102-20) |
| 3                                | 201335 | EP162048 (P-102-24) |          |                     |
| 1.004                            | 1.254  | 1/2                 | 401324   | SS-3240-8           |
|                                  |        | 3/4                 | 401325   | SS-3240-12          |
|                                  |        | 7/8                 | 401326   | SS-3240-14          |
|                                  |        | 1                   | 401327   | SS-3240-16          |
|                                  |        | 1-1/4               | 401328   | SS-3240-20          |
|                                  |        | 1-3/8               | 401329   | SS-3240-22          |
|                                  |        | 1-1/2               | 401330   | SS-3240-24          |
|                                  |        | 1-3/4               | 401331   | SS-3240-28          |
|                                  |        | 2                   | 401332   | SS-3240-32          |
|                                  |        | 2-1/4               | 401333   | SS-3240-36          |
|                                  |        | 2-1/2               | 401334   | SS-3240-40          |
|                                  |        | 3                   | 401335   | SS-3240-48          |
|                                  |        | 1.005               | 1.2525   | 1                   |
| 1-1/4                            | 101534 |                     |          | AA-1204-2           |
| 1-3/8                            | 101535 |                     |          | AA-1204-1           |
| 1-1/2                            | 101536 |                     |          | AA-1204             |

| ID                        | OD     | LGTH.                    | ITEM NO. | PART NO.            |
|---------------------------|--------|--------------------------|----------|---------------------|
| 1.005                     | 1.2525 | 2                        | 101537   | AA-1204-3           |
|                           |        | 2-1/4                    | 101538   | AA-1204-5           |
|                           |        | 2-1/2                    | 101539   | AA-1204-4           |
| <b>1 X 1-5/16 NOMINAL</b> |        |                          |          |                     |
| 1.001                     | 1.316  | 1                        | 101540   | AA-1304-3           |
|                           |        | 1-1/2                    | 101541   | AA-1304             |
|                           |        | 1-3/4                    | 101542   | AA-1304-4           |
| 1.002                     | 1.315  | 2                        | 101543   | AA-1304-6           |
|                           |        | 1                        | 101544   | AA-1325-10          |
|                           |        | 1-1/4                    | 101545   | AA-1325-8           |
|                           |        | 1-1/2                    | 101546   | AA-1325-4           |
|                           |        | 1-5/8                    | 101547   | AA-1325-7           |
|                           |        | 1-3/4                    | 101548   | AA-1325-5           |
|                           |        | 2                        | 101549   | AA-1325             |
| 1.003                     | 1.3155 | 1                        | 301293   | B-1621-8            |
|                           |        | 1-1/4                    | 301294   | B-1621-10           |
|                           |        | 1-1/2                    | 301295   | B-1621-12           |
|                           |        | 1-3/4                    | 301296   | B-1621-14           |
|                           |        | 2                        | 301297   | B-1621-16           |
|                           |        | 2-1/2                    | 301298   | B-1621-20           |
|                           |        | 3                        | 301299   | B-1621-24           |
| 1.003                     | 1.3165 | 1                        | 201336   | EP162116 (P-103-8)  |
|                           |        | 1-1/4                    | 201337   | EP162120 (P-103-10) |
|                           |        | 1-1/2                    | 201338   | EP162124 (P-103-12) |
|                           |        | 1-3/4                    | 201339   | EP162128 (P-103-14) |
|                           |        | 2                        | 201340   | EP162132 (P-103-16) |
|                           |        | 2-1/2                    | 201341   | EP162140 (P-103-20) |
| 1.004                     | 1.316  | 3                        | 201342   | EP162148 (P-103-24) |
|                           |        | 1                        | 401336   | SS-3242-16          |
|                           |        | 1-1/4                    | 401337   | SS-3242-20          |
|                           |        | 1-1/2                    | 401338   | SS-3242-24          |
|                           |        | 1-3/4                    | 401339   | SS-3242-28          |
|                           |        | 2                        | 401340   | SS-3242-32          |
| 1.004                     | 1.254  | 2-1/2                    | 401341   | SS-3242-40          |
|                           |        | 3                        | 401342   | SS-3242-48          |
|                           |        | <b>1 X 1-3/8 NOMINAL</b> |          |                     |
| 1.001                     | 1.378  | 3/4                      | 101553   | AA-1334-3           |
|                           |        | 1-1/4                    | 101554   | AA-1334-5           |
|                           |        | 1-1/2                    | 101555   | AA-1334-1           |
| 1.003                     | 1.377  | 2                        | 101556   | AA-1334-2           |
|                           |        | 1                        | 101557   | AA-1310-2           |
|                           |        | 1-1/8                    | 101558   | AA-1310-1           |
|                           |        | 1-1/4                    | 101559   | AA-1310-4           |
|                           |        | 1-3/8                    | 101560   | AA-1310             |
|                           |        | 1-1/2                    | 101561   | AA-1310-5           |
| 1.004                     | 1.254  | 1-3/4                    | 101562   | AA-1310-8           |
|                           |        | 2                        | 101563   | AA-1310-3           |
|                           |        | 2-1/4                    | 101564   | AA-1310-6           |

| ID                       | OD     | LGTH.                          | ITEM NO. | PART NO.            |  |  |
|--------------------------|--------|--------------------------------|----------|---------------------|--|--|
| 1.003                    | 1.378  | 1                              | 301300   | B-1622-8            |  |  |
|                          |        | 1-1/4                          | 301301   | B-1622-10           |  |  |
|                          |        | 1-1/2                          | 301302   | B-1622-12           |  |  |
|                          |        | 1-3/4                          | 301303   | B-1622-14           |  |  |
|                          |        | 2                              | 301304   | B-1622-16           |  |  |
|                          |        | 2-1/2                          | 301305   | B-1622-20           |  |  |
| 1.003                    | 1.379  | 3                              | 301306   | B-1622-24           |  |  |
|                          |        | 1                              | 201343   | EP162216 (P-104-8)  |  |  |
|                          |        | 1-1/4                          | 201344   | EP162220 (P-104-10) |  |  |
|                          |        | 1-1/2                          | 201345   | EP162224 (P-104-12) |  |  |
| 1.004                    | 1.379  | 1-3/4                          | 201346   | EP162228 (P-104-14) |  |  |
|                          |        | 2                              | 201347   | EP162232 (P-104-16) |  |  |
|                          |        | 2-1/2                          | 201348   | EP162240 (P-104-20) |  |  |
|                          |        | 3/4                            | 401343   | SS-3244-12          |  |  |
|                          |        | 1                              | 401344   | SS-3244-16          |  |  |
|                          |        | 1-1/4                          | 401345   | SS-3244-20          |  |  |
| 1.003                    | 1.503  | 1-1/2                          | 401346   | SS-3244-24          |  |  |
|                          |        | 1-3/4                          | 401347   | SS-3244-28          |  |  |
|                          |        | 2                              | 401348   | SS-3244-32          |  |  |
|                          |        | 2-1/2                          | 401349   | SS-3244-40          |  |  |
| <b>1 X 1-1/2 NOMINAL</b> |        |                                |          |                     |  |  |
| 1.003                    | 1.503  | 1                              | 301307   | B-1624-8            |  |  |
|                          |        | 1-1/4                          | 301308   | B-1624-10           |  |  |
|                          |        | 1-1/2                          | 301309   | B-1624-12           |  |  |
|                          |        | 2                              | 301310   | B-1624-16           |  |  |
| 1.003                    | 1.504  | 2-1/2                          | 301311   | B-1624-20           |  |  |
|                          |        | 3                              | 301312   | B-1624-24           |  |  |
|                          |        | 1                              | 201349   | EP162416 (P-105-8)  |  |  |
|                          |        | 1-1/4                          | 201350   | EP162420 (P-105-10) |  |  |
|                          |        | 1-1/2                          | 201351   | EP162424 (P-105-12) |  |  |
|                          |        | 1-3/4                          | 201352   | EP162428 (P-105-14) |  |  |
| 1.0035                   | 1.5045 | 2                              | 201353   | EP162432 (P-105-16) |  |  |
|                          |        | 2-1/2                          | 201354   | EP162440 (P-105-20) |  |  |
|                          |        | 3                              | 201355   | EP162448 (P-105-24) |  |  |
|                          |        | 1                              | 101565   | AA-1511-7           |  |  |
| 1.004                    | 1.504  | 1-1/4                          | 101566   | AA-1511-8           |  |  |
|                          |        | 1-1/2                          | 101567   | AA-1511-5           |  |  |
|                          |        | 2                              | 101568   | AA-1511-1           |  |  |
| 1.004                    | 1.504  | 1                              | 401350   | SS-3248-16          |  |  |
|                          |        | 1-1/4                          | 401351   | SS-3248-20          |  |  |
|                          |        | 1-1/2                          | 401352   | SS-3248-24          |  |  |
|                          |        | 1-3/4                          | 401353   | SS-3248-28          |  |  |
|                          |        | 2                              | 401354   | SS-3248-32          |  |  |
|                          |        | 2-1/2                          | 401355   | SS-3248-40          |  |  |
| 1.064                    | 1.317  | 3                              | 401356   | SS-3248-48          |  |  |
|                          |        | <b>1-1/16 X 1-5/16 NOMINAL</b> |          |                     |  |  |
|                          |        | 3/4                            | 101569   | AA-1307-2           |  |  |
| 1.004                    | 1.254  | 1                              | 101570   | AA-1307-4           |  |  |
|                          |        | 1-1/4                          | 101571   | AA-1307-5           |  |  |
|                          |        | 1-1/2                          | 101572   | AA-1307-1           |  |  |





| ID                                     | OD     | LGTH. | ITEM NO. | PART NO.            |
|----------------------------------------|--------|-------|----------|---------------------|
| <b>1-1/16 X 1-5/16 NOMINAL (cont.)</b> |        |       |          |                     |
| 1.065                                  | 1.316  | 1     | 401357   | SS-3442-16          |
|                                        |        | 1-1/2 | 401358   | SS-3442-24          |
|                                        |        | 2     | 401359   | SS-3442-32          |
|                                        |        | 2-1/2 | 401360   | SS-3442-40          |
| 1.0655                                 | 1.3155 | 1     | 301313   | B-1721-8            |
|                                        |        | 1-1/2 | 301314   | B-1721-12           |
|                                        |        | 2     | 301315   | B-1721-16           |
|                                        |        | 2-1/2 | 301316   | B-1721-20           |
| 1.0655                                 | 1.3165 | 1     | 201356   | EP172116 (P-106-8)  |
|                                        |        | 1-1/2 | 201357   | EP172124 (P-106-12) |
|                                        |        | 2     | 201358   | EP172132 (P-106-16) |
|                                        |        | 2-1/2 | 201359   | EP172140 (P-106-20) |
| <b>1-1/8 X 1-1/4 NOMINAL</b>           |        |       |          |                     |
| 1.1245                                 | 1.2535 | 7/8   | 101573   | AA-1214-6           |
|                                        |        | 1     | 101574   | AA-1214-3           |
|                                        |        | 1-1/8 | 101575   | AA-1214-2           |
|                                        |        | 1-1/4 | 101576   | AA-1214-1           |
|                                        |        | 1-1/2 | 101577   | AA-1214-8           |
| 1.127                                  | 1.2525 | 1-1/4 | 101578   | AA-1250-2           |
|                                        |        | 1-1/2 | 101579   | AA-1250-3           |
| 1.128                                  | 1.254  | 1     | 201360   | EP182016 (P-112-8)  |
|                                        |        | 1-1/4 | 201361   | EP182020 (P-112-10) |
|                                        |        | 1-1/2 | 201362   | EP182024 (P-112-12) |
| 1.129                                  | 1.254  | 1     | 401361   | SS-3640-16          |
|                                        |        | 1-1/4 | 401362   | SS-3640-20          |
|                                        |        | 1-1/2 | 401363   | SS-3640-24          |
| <b>1-1/8 X 1-5/16 NOMINAL</b>          |        |       |          |                     |
| 1.1265                                 | 1.3155 | 1     | 101580   | AA-1317             |
|                                        |        | 1-1/4 | 101581   | AA-1317-1           |
| 1.128                                  | 1.3155 | 1     | 301317   | B-1821-8            |
|                                        |        | 1-1/4 | 301318   | B-1821-10           |
|                                        |        | 1-1/2 | 301319   | B-1821-12           |
|                                        |        | 2     | 301320   | B-1821-16           |
| 1.128                                  | 1.3165 | 1     | 201363   | EP182116 (P-113-8)  |
|                                        |        | 1-1/4 | 201364   | EP182120 (P-113-10) |
|                                        |        | 1-1/2 | 201365   | EP182124 (P-113-12) |
|                                        |        | 1-3/4 | 201366   | EP182128 (P-113-14) |
|                                        |        | 2     | 201367   | EP182132 (P-113-16) |
| 1.129                                  | 1.316  | 1     | 401364   | SS-3642-16          |
|                                        |        | 1-1/4 | 401365   | SS-3642-20          |
|                                        |        | 1-1/2 | 401366   | SS-3642-24          |
|                                        |        | 1-3/4 | 401367   | SS-3642-28          |
|                                        |        | 2     | 401368   | SS-3642-32          |
| <b>1-1/8 X 1-3/8 NOMINAL</b>           |        |       |          |                     |
| 1.127                                  | 1.377  | 1/2   | 101582   | AA-1332-6           |
|                                        |        | 3/4   | 101583   | AA-1332-1           |
|                                        |        | 1     | 101584   | AA-1332-4           |
|                                        |        | 1-1/4 | 101585   | AA-1332-9           |
|                                        |        | 1-1/2 | 101586   | AA-1332-7           |
|                                        |        | 1-3/4 | 101587   | AA-1332-10          |
|                                        |        | 2     | 101588   | AA-1332             |

| ID                           | OD     | LGTH. | ITEM NO. | PART NO.            |
|------------------------------|--------|-------|----------|---------------------|
| 1.127                        | 1.377  | 2-1/4 | 101589   | AA-1332-11          |
|                              |        | 2-1/2 | 101590   | AA-1332-2           |
|                              |        | 3     | 101591   | AA-1332-8           |
| 1.128                        | 1.378  | 3/4   | 301321   | B-1822-6            |
|                              |        | 1     | 301322   | B-1822-8            |
|                              |        | 1-1/4 | 301323   | B-1822-10           |
|                              |        | 1-1/2 | 301324   | B-1822-12           |
|                              |        | 1-3/4 | 301325   | B-1822-14           |
|                              |        | 2     | 301326   | B-1822-16           |
|                              |        | 2-1/2 | 301327   | B-1822-20           |
|                              |        | 3     | 301328   | B-1822-24           |
| 1.128                        | 1.379  | 1/2   | 201579   | EP182208 (P-114-4)  |
|                              |        | 3/4   | 201368   | EP182212 (P-114-6)  |
|                              |        | 1     | 201369   | EP182216 (P-114-8)  |
|                              |        | 1-1/4 | 201370   | EP182220 (P-114-10) |
|                              |        | 1-1/2 | 201371   | EP182224 (P-114-12) |
|                              |        | 1-3/4 | 201372   | EP182228 (P-114-14) |
|                              |        | 2     | 201373   | EP182232 (P-114-16) |
|                              |        | 2-1/2 | 201374   | EP182240 (P-114-20) |
|                              |        | 3     | 201375   | EP182248 (P-114-24) |
| 1.129                        | 1.379  | 1/2   | 101592   | AA-1319-10          |
|                              |        | 1     | 101593   | AA-1319-3           |
|                              |        | 1-1/4 | 101594   | AA-1319             |
|                              |        | 1-1/2 | 101595   | AA-1319-13          |
|                              |        | 1-3/4 | 101596   | AA-1319-5           |
|                              |        | 2     | 101597   | AA-1319-1           |
|                              |        | 2-1/4 | 101598   | AA-1319-12          |
|                              |        | 2-1/2 | 101599   | AA-1319-2           |
| 1.129                        | 1.379  | 3/4   | 401369   | SS-3644-12          |
|                              |        | 1     | 401370   | SS-3644-16          |
|                              |        | 1-1/4 | 401371   | SS-3644-20          |
|                              |        | 1-1/2 | 401372   | SS-3644-24          |
|                              |        | 1-3/4 | 401373   | SS-3644-28          |
|                              |        | 2     | 401374   | SS-3644-32          |
|                              |        | 2-1/2 | 401375   | SS-3644-40          |
|                              |        | 3     | 401376   | SS-3644-48          |
| <b>1-1/8 X 1-1/2 NOMINAL</b> |        |       |          |                     |
| 1.126                        | 1.503  | 1     | 101600   | AA-1509-4           |
|                              |        | 1-1/2 | 101601   | AA-1509-1           |
|                              |        | 1-3/4 | 101602   | AA-1509-6           |
|                              |        | 2     | 101603   | AA-1509             |
|                              |        | 2-1/2 | 101604   | AA-1509-3           |
| 1.127                        | 1.5035 | 1     | 101605   | AA-1502             |
|                              |        | 1-1/4 | 101606   | AA-1502-2           |
|                              |        | 1-1/2 | 101607   | AA-1502-3           |
| 1.128                        | 1.504  | 1     | 201376   | EP182416 (P-115-8)  |
|                              |        | 1-1/4 | 201377   | EP182420 (P-115-10) |
|                              |        | 1-1/2 | 201378   | EP182424 (P-115-12) |
|                              |        | 1-3/4 | 201379   | EP182428 (P-115-14) |
|                              |        | 2     | 201380   | EP182432 (P-115-16) |
|                              |        | 2-1/2 | 201381   | EP182440 (P-115-20) |
| 1.129                        | 1.504  | 1     | 401377   | SS-3648-16          |
|                              |        | 1-1/4 | 401378   | SS-3648-20          |

| ID                             | OD     | LGTH. | ITEM NO. | PART NO.            |
|--------------------------------|--------|-------|----------|---------------------|
| 1.129                          | 1.504  | 1-1/2 | 401379   | SS-3648-24          |
|                                |        | 1-3/4 | 401380   | SS-3648-28          |
|                                |        | 2     | 401381   | SS-3648-32          |
|                                |        | 2-1/2 | 401382   | SS-3648-40          |
| <b>1-3/16 X 1-5/16 NOMINAL</b> |        |       |          |                     |
| 1.189                          | 1.3155 | 1     | 101608   | AA-1339-2           |
|                                |        | 1-1/4 | 101609   | AA-1339             |
| <b>1-3/16 X 1-3/8 NOMINAL</b>  |        |       |          |                     |
| 1.189                          | 1.379  | 1-1/2 | 101610   | AA-1324-1           |
|                                |        | 1-3/4 | 101611   | AA-1324             |
| <b>1-3/16 X 1-7/16 NOMINAL</b> |        |       |          |                     |
| 1.1885                         | 1.441  | 1-1/4 | 101612   | AA-1403-3           |
|                                |        | 1-1/2 | 101613   | AA-1403-7           |
|                                |        | 2     | 101614   | AA-1403-10          |
| 1.1905                         | 1.441  | 1-1/4 | 301329   | B-1923-10           |
|                                |        | 2     | 301330   | B-1923-16           |
|                                |        | 2-1/2 | 301331   | B-1923-20           |
|                                |        | 3     | 301332   | B-1923-24           |
| 1.1905                         | 1.4415 | 1-1/4 | 201382   | EP192320 (P-118-10) |
|                                |        | 1-1/2 | 201383   | EP192324 (P-118-12) |
|                                |        | 2     | 201384   | EP192332 (P-118-16) |
|                                |        | 2-1/2 | 201385   | EP192340 (P-118-20) |
|                                |        | 3     | 201386   | EP192348 (P-118-24) |
| 1.192                          | 1.441  | 1-1/4 | 401383   | SS-3846-20          |
|                                |        | 1-1/2 | 401384   | SS-3846-24          |
|                                |        | 2     | 401385   | SS-3846-32          |
|                                |        | 2-1/2 | 401386   | SS-3846-40          |
|                                |        | 3     | 401387   | SS-3846-48          |
| <b>1-3/16 X 1-1/2 NOMINAL</b>  |        |       |          |                     |
| 1.190                          | 1.504  | 1     | 101615   | AA-1523-2           |
|                                |        | 1-1/2 | 101616   | AA-1523-5           |
|                                |        | 2     | 101617   | AA-1523             |
|                                |        | 2-1/2 | 101618   | AA-1523-3           |
| 1.1905                         | 1.503  | 1     | 301333   | B-1924-8            |
|                                |        | 1-1/4 | 301334   | B-1924-10           |
|                                |        | 1-1/2 | 301335   | B-1924-12           |
|                                |        | 1-3/4 | 301336   | B-1924-14           |
|                                |        | 2     | 301337   | B-1924-16           |
|                                |        | 2-1/2 | 301338   | B-1924-20           |
|                                |        | 3     | 301339   | B-1924-24           |
| 1.1905                         | 1.504  | 1     | 201387   | EP192416 (P-119-8)  |
|                                |        | 1-1/4 | 201388   | EP192420 (P-119-10) |
|                                |        | 1-1/2 | 201389   | EP192424 (P-119-12) |
|                                |        | 1-3/4 | 201390   | EP192428 (P-119-14) |
|                                |        | 2     | 201391   | EP192432 (P-119-16) |
|                                |        | 2-1/2 | 201392   | EP192440 (P-119-20) |
|                                |        | 3     | 201393   | EP192448 (P-119-24) |

\*Other sizes, tolerances, lubricants and materials are available on special orders.



| ID                                    | OD     | LGTH. | ITEM NO. | PART NO.           | ID                            | OD     | LGTH. | ITEM NO. | PART NO.            | ID                            | OD    | LGTH. | ITEM NO. | PART NO.            |
|---------------------------------------|--------|-------|----------|--------------------|-------------------------------|--------|-------|----------|---------------------|-------------------------------|-------|-------|----------|---------------------|
| <b>1-3/16 X 1-1/2 NOMINAL (cont.)</b> |        |       |          |                    |                               |        |       |          |                     |                               |       |       |          |                     |
| 1.192                                 | 1.504  | 1     | 401388   | SS-3848-16         | 1.2535                        | 1.504  | 1-1/4 | 201400   | EP202420 (P-125-10) | 1.253                         | 1.628 | 2     | 301355   | B-2026-16           |
|                                       |        | 1-1/4 | 401389   | SS-3848-20         |                               |        | 1-3/8 | 201401   | EP202422 (P-125-11) |                               |       | 2-1/2 | 301356   | B-2026-20           |
|                                       |        | 1-1/2 | 401390   | SS-3848-24         |                               |        | 1-1/2 | 201402   | EP202424 (P-125-12) |                               |       | 3     | 301357   | B-2026-24           |
|                                       |        | 1-3/4 | 401391   | SS-3848-28         |                               |        | 1-5/8 | 201403   | EP202426 (P-125-13) | 1.2535                        | 1.630 | 1     | 201410   | EP202616 (P-126-8)  |
|                                       |        | 2     | 401392   | SS-3848-32         |                               |        | 1-3/4 | 201404   | EP202428 (P-125-14) |                               |       | 1-1/4 | 201411   | EP202620 (P-126-10) |
|                                       |        | 2-1/2 | 401393   | SS-3848-40         |                               |        | 1-7/8 | 201405   | EP202430 (P-125-15) |                               |       | 1-1/2 | 201412   | EP202624 (P-126-12) |
|                                       |        | 3     | 401394   | SS-3848-48         |                               |        | 2     | 201406   | EP202432 (P-125-16) |                               |       | 1-3/4 | 201413   | EP202628 (P-126-14) |
| 1.193                                 | 1.504  | 1     | 101619   | AA-1504-6          |                               |        | 2-1/4 | 201407   | EP202436 (P-125-18) |                               |       | 2     | 201414   | EP202632 (P-126-16) |
|                                       |        | 1-1/2 | 101620   | AA-1504-1          |                               |        | 2-1/2 | 201408   | EP202440 (P-125-20) |                               |       | 2-1/2 | 201415   | EP202640 (P-126-20) |
| <b>1-1/4 X 1-7/16 NOMINAL</b>         |        |       |          |                    | 1.254                         | 1.504  | 1/2   | 401395   | SS-4048-8           |                               |       | 3     | 201416   | EP202648 (P-126-24) |
| 1.2515                                | 1.4405 | 1-1/4 | 101621   | AA-1407-4          |                               |        | 5/8   | 401396   | SS-4048-10          | 1.254                         | 1.629 | 1-1/2 | 101660   | AA-1604             |
|                                       |        | 1-1/2 | 101622   | AA-1407-5          |                               |        | 3/4   | 401397   | SS-4048-12          |                               |       | 1-3/4 | 101661   | AA-1604-2           |
|                                       |        | 1-3/4 | 101623   | AA-1407            |                               |        | 7/8   | 401398   | SS-4048-14          | 1.254                         | 1.629 | 1     | 401415   | SS-4052-16          |
|                                       |        | 2     | 101624   | AA-1407-6          |                               |        | 1     | 401399   | SS-4048-16          |                               |       | 1-1/4 | 401416   | SS-4052-20          |
|                                       |        | 2-1/2 | 101625   | AA-1407-8          |                               |        | 1-1/8 | 401400   | SS-4048-18          |                               |       | 1-1/2 | 401417   | SS-4052-24          |
| <b>1-1/4 X 1-1/2 NOMINAL</b>          |        |       |          |                    |                               |        | 1-1/4 | 401401   | SS-4048-20          |                               |       | 1-3/4 | 401418   | SS-4052-28          |
| 1.250                                 | 1.502  | 3/4   | 101626   | AA-1517-4          |                               |        | 1-3/8 | 401402   | SS-4048-22          |                               |       | 2     | 401419   | SS-4052-32          |
|                                       |        | 1-1/4 | 101627   | AA-1517-6          |                               |        | 1-1/2 | 401403   | SS-4048-24          |                               |       | 2-1/2 | 401420   | SS-4052-40          |
|                                       |        | 1-5/8 | 101628   | AA-1517-1          |                               |        | 1-5/8 | 401404   | SS-4048-26          |                               |       | 3     | 401421   | SS-4052-48          |
| 1.252                                 | 1.502  | 1/2   | 101629   | AA-1512-12         |                               |        | 1-3/4 | 401405   | SS-4048-28          | <b>1-1/4 X 1-3/4 NOMINAL</b>  |       |       |          |                     |
|                                       |        | 5/8   | 101630   | AA-1512-11         |                               |        | 1-7/8 | 401406   | SS-4048-30          | 1.2535                        | 1.755 | 1-3/4 | 201417   | EP202828 (P-127-14) |
|                                       |        | 3/4   | 101631   | AA-1512-14         |                               |        | 2     | 401407   | SS-4048-32          |                               |       | 2     | 201418   | EP202832 (P-127-16) |
|                                       |        | 7/8   | 101632   | AA-1512-7          |                               |        | 2-1/4 | 401408   | SS-4048-36          |                               |       | 2-1/2 | 201419   | EP202840 (P-127-20) |
|                                       |        | 1     | 101633   | AA-1512-15         |                               |        | 2-1/2 | 401409   | SS-4048-40          |                               |       | 3     | 201420   | EP202848 (P-127-24) |
|                                       |        | 1-1/4 | 101634   | AA-1512-16         |                               |        | 3     | 401410   | SS-4048-48          | 1.254                         | 1.753 | 1-1/2 | 101662   | AA-1715-6           |
|                                       |        | 1-3/8 | 101635   | AA-1512-3          | 1.258                         | 1.504  | 1     | 101644   | AA-1505-11          |                               |       | 2     | 101663   | AA-1715-2           |
|                                       |        | 1-1/2 | 101636   | AA-1512-2          |                               |        | 1-1/2 | 101645   | AA-1505-1           |                               |       | 3     | 101664   | AA-1715-3           |
|                                       |        | 1-3/4 | 101637   | AA-1512-17         | <b>1-1/4 X 1-9/16 NOMINAL</b> |        |       |          |                     | 1.254                         | 1.754 | 1-1/2 | 401422   | SS-4056-24          |
|                                       |        | 1-7/8 | 101638   | AA-1512-1          | 1.252                         | 1.565  | 1-1/4 | 101646   | AA-1506-12          |                               |       | 1-3/4 | 401423   | SS-4056-28          |
|                                       |        | 2     | 101639   | AA-1512-5          |                               |        | 1-1/2 | 101647   | AA-1506-6           |                               |       | 2     | 401424   | SS-4056-32          |
|                                       |        | 2-1/2 | 101640   | AA-1512-13         |                               |        | 1-3/4 | 101648   | AA-1506             |                               |       | 2-1/2 | 401425   | SS-4056-40          |
| 1.253                                 | 1.503  | 1     | 301340   | B-2024-8           |                               |        | 2     | 101649   | AA-1506-7           |                               |       | 3     | 401426   | SS-4056-48          |
|                                       |        | 1-1/8 | 301341   | B-2024-9           |                               |        | 2-1/4 | 101650   | AA-1506-8           | <b>1-5/16 X 1-1/2 NOMINAL</b> |       |       |          |                     |
|                                       |        | 1-1/4 | 301342   | B-2024-10          | 1.254                         | 1.566  | 1     | 401411   | SS-4050-16          | 1.3155                        | 1.503 | 1     | 101665   | AA-1526-4           |
|                                       |        | 1-3/8 | 301343   | B-2024-11          |                               |        | 1-1/2 | 401412   | SS-4050-24          |                               |       | 1-1/4 | 101666   | AA-1526             |
|                                       |        | 1-1/2 | 301344   | B-2024-12          | <b>1-1/4 X 1-5/8 NOMINAL</b>  |        |       |          |                     |                               |       | 1-1/2 | 101667   | AA-1526-2           |
|                                       |        | 1-5/8 | 301345   | B-2024-13          | 1.250                         | 1.627  | 1-1/2 | 101651   | AA-1602             |                               |       | 2     | 101668   | AA-1526-3           |
|                                       |        | 1-3/4 | 301346   | B-2024-14          | 1.252                         | 1.6275 | 1     | 101652   | AA-1606-9           | <b>1-5/16 X 1-5/8 NOMINAL</b> |       |       |          |                     |
|                                       |        | 2     | 301347   | B-2024-16          |                               |        | 1-1/4 | 101653   | AA-1606             | 1.3155                        | 1.628 | 1-1/4 | 301358   | B-2126-10           |
|                                       |        | 2-1/4 | 301348   | B-2024-18          |                               |        | 1-1/2 | 101654   | AA-1606-7           |                               |       | 1-1/2 | 301359   | B-2126-12           |
|                                       |        | 2-1/2 | 301349   | B-2024-20          |                               |        | 1-5/8 | 101655   | AA-1606-11          |                               |       | 2     | 301360   | B-2126-16           |
|                                       |        | 3     | 301350   | B-2024-24          |                               |        | 1-3/4 | 101656   | AA-1606-1           |                               |       | 2-1/2 | 301361   | B-2126-20           |
| 1.2535                                | 1.504  | 1     | 101641   | AA-1528            |                               |        | 2     | 101657   | AA-1606-3           |                               |       | 3     | 301362   | B-2126-24           |
|                                       |        | 1-1/4 | 101642   | AA-1528-3          |                               |        | 2-1/2 | 101658   | AA-1606-5           | 1.3155                        | 1.629 | 1-1/2 | 101669   | AA-1611-5           |
|                                       |        | 1-1/2 | 101643   | AA-1528-4          |                               |        | 3     | 101659   | AA-1606-4           |                               |       | 2     | 101670   | AA-1611-2           |
| 1.2535                                | 1.504  | 1/2   | 201394   | EP202408 (P-125-4) | 1.253                         | 1.628  | 1     | 301351   | B-2026-8            |                               |       | 2-1/2 | 101671   | AA-1611             |
|                                       |        | 5/8   | 201395   | EP202410 (P-125-5) |                               |        | 1-1/4 | 301352   | B-2026-10           |                               |       |       |          |                     |
|                                       |        | 3/4   | 201396   | EP202412 (P-125-6) |                               |        | 1-1/2 | 301353   | B-2026-12           |                               |       |       |          |                     |
|                                       |        | 7/8   | 201397   | EP202414 (P-125-7) |                               |        | 1-3/4 | 301354   | B-2026-14           |                               |       |       |          |                     |
|                                       |        | 1     | 201398   | EP202416 (P-125-8) |                               |        |       |          |                     |                               |       |       |          |                     |
|                                       |        | 1-1/8 | 201399   | EP202418 (P-125-9) |                               |        |       |          |                     |                               |       |       |          |                     |

\*Other sizes, tolerances, lubricants and materials are available on special orders.



| ID                                    | OD     | LGTH. | ITEM NO. | PART NO.            |
|---------------------------------------|--------|-------|----------|---------------------|
| <b>1-5/16 X 1-5/8 NOMINAL (cont.)</b> |        |       |          |                     |
| 1.316                                 | 1.629  | 1-1/4 | 401430   | SS-4252-20          |
|                                       |        | 1-1/2 | 401431   | SS-4252-24          |
|                                       |        | 2     | 401432   | SS-4252-32          |
|                                       |        | 2-1/2 | 401433   | SS-4252-40          |
|                                       |        | 3     | 401434   | SS-4252-48          |
| 1.316                                 | 1.630  | 1-1/4 | 201421   | EP212620 (P-131-10) |
|                                       |        | 1-1/2 | 201422   | EP212624 (P-131-12) |
|                                       |        | 2     | 201423   | EP212632 (P-131-16) |
|                                       |        | 2-1/2 | 201424   | EP212640 (P-131-20) |
|                                       |        | 3     | 201425   | EP212648 (P-131-24) |
| <b>1-3/8 X 1-9/16 NOMINAL</b>         |        |       |          |                     |
| 1.3745                                | 1.5655 | 1-1/4 | 101672   | AA-1507-2           |
|                                       |        | 1-1/2 | 101673   | AA-1507             |
| <b>1-3/8 X 1-5/8 NOMINAL</b>          |        |       |          |                     |
| 1.376                                 | 1.628  | 1     | 101674   | AA-1608-10          |
|                                       |        | 1-1/8 | 101675   | AA-1608-1           |
|                                       |        | 1-1/4 | 101676   | AA-1608-11          |
|                                       |        | 1-1/2 | 101677   | AA-1608-12          |
|                                       |        | 1-3/4 | 101678   | AA-1608-13          |
|                                       |        | 2     | 101679   | AA-1608             |
|                                       |        | 2-1/2 | 101680   | AA-1608-3           |
| 1.378                                 | 1.628  | 1     | 301363   | B-2226-8            |
|                                       |        | 1-1/2 | 301364   | B-2226-12           |
|                                       |        | 2     | 301365   | B-2226-16           |
|                                       |        | 2-1/2 | 301366   | B-2226-20           |
|                                       |        | 3     | 301367   | B-2226-24           |
| 1.3785                                | 1.630  | 1     | 201426   | EP222616 (P-137-8)  |
|                                       |        | 1-1/8 | 201427   | EP222618 (P-137-9)  |
|                                       |        | 1-1/4 | 201428   | EP222620 (P-137-10) |
|                                       |        | 1-1/2 | 201429   | EP222624 (P-137-12) |
|                                       |        | 2     | 201430   | EP222632 (P-137-16) |
|                                       |        | 2-1/2 | 201431   | EP222640 (P-137-20) |
|                                       |        | 3     | 201432   | EP222648 (P-137-24) |
| 1.379                                 | 1.628  | 1-1/2 | 101681   | AA-1616-3           |
|                                       |        | 2     | 101682   | AA-1616-5           |
|                                       |        | 2-1/2 | 101683   | AA-1616-7           |
| 1.379                                 | 1.629  | 1     | 401435   | SS-4452-16          |
|                                       |        | 1-1/8 | 401436   | SS-4452-18          |
|                                       |        | 1-1/4 | 401437   | SS-4452-20          |
|                                       |        | 1-1/2 | 401438   | SS-4452-24          |
|                                       |        | 2     | 401439   | SS-4452-32          |
|                                       |        | 2-1/2 | 401440   | SS-4452-40          |
|                                       |        | 3     | 401441   | SS-4452-48          |
| <b>1-3/8 X 1-3/4 NOMINAL</b>          |        |       |          |                     |
| 1.378                                 | 1.753  | 1     | 301368   | B-2228-8            |
|                                       |        | 1-1/2 | 301369   | B-2228-12           |
|                                       |        | 2     | 301370   | B-2228-16           |
|                                       |        | 2-1/2 | 301371   | B-2228-20           |
|                                       |        | 3     | 301372   | B-2228-24           |

| ID                            | OD    | LGTH.  | ITEM NO. | PART NO.            |        |            |
|-------------------------------|-------|--------|----------|---------------------|--------|------------|
| 1.3785                        | 1.755 | 1      | 201433   | EP222816 (P-138-8)  |        |            |
|                               |       | 1-1/2  | 201434   | EP222824 (P-138-12) |        |            |
|                               |       | 2      | 201435   | EP222832 (P-138-16) |        |            |
|                               |       | 2-1/2  | 201436   | EP222840 (P-138-20) |        |            |
|                               |       | 3      | 201437   | EP222848 (P-138-24) |        |            |
| 1.379                         | 1.754 | 1      | 401442   | SS-4456-16          |        |            |
|                               |       | 1-1/2  | 401443   | SS-4456-24          |        |            |
|                               |       | 2      | 401444   | SS-4456-32          |        |            |
|                               |       | 2-1/2  | 401445   | SS-4456-40          |        |            |
|                               |       | 3      | 401446   | SS-4456-48          |        |            |
| 1.380                         | 1.753 | 1-1/2  | 101684   | AA-1708-5           |        |            |
|                               |       | 2      | 101685   | AA-1708-2           |        |            |
|                               |       | 2-1/2  | 101686   | AA-1708             |        |            |
| <b>1-7/16 X 1-5/8 NOMINAL</b> |       |        |          |                     |        |            |
| 1.438                         | 1.628 | 1      | 101687   | AA-1609-2           |        |            |
|                               |       | 1-1/2  | 101688   | AA-1609-4           |        |            |
|                               |       | 2      | 101689   | AA-1609             |        |            |
|                               |       | 2-1/4  | 101690   | AA-1609-6           |        |            |
| 1.441                         | 1.630 | 1      | 201438   | EP232616 (P-143-8)  |        |            |
|                               |       | 1-1/2  | 201439   | EP232624 (P-143-12) |        |            |
|                               |       | 2      | 201440   | EP232632 (P-143-16) |        |            |
| 1.442                         | 1.629 | 1      | 401447   | SS-4652-16          |        |            |
|                               |       | 1-1/2  | 401448   | SS-4652-24          |        |            |
|                               |       | 2      | 401449   | SS-4652-32          |        |            |
| <b>1-7/16 X 1-3/4 NOMINAL</b> |       |        |          |                     |        |            |
| 1.4405                        | 1.753 | 1      | 301373   | B-2328-8            |        |            |
|                               |       | 1-1/4  | 301374   | B-2328-10           |        |            |
|                               |       | 1-1/2  | 301375   | B-2328-12           |        |            |
|                               |       | 1-3/4  | 301376   | B-2328-14           |        |            |
|                               |       | 2      | 301377   | B-2328-16           |        |            |
|                               |       | 2-1/2  | 301378   | B-2328-20           |        |            |
|                               |       | 3      | 301379   | B-2328-24           |        |            |
| 1.441                         | 1.755 | 1      | 201441   | EP232816 (P-144-8)  |        |            |
|                               |       | 1-1/4  | 201442   | EP232820 (P-144-10) |        |            |
|                               |       | 1-1/2  | 201443   | EP232824 (P-144-12) |        |            |
|                               |       | 1-3/4  | 201444   | EP232828 (P-144-14) |        |            |
|                               |       | 2      | 201445   | EP232832 (P-144-16) |        |            |
|                               |       | 2-1/2  | 201446   | EP232840 (P-144-20) |        |            |
|                               |       | 3      | 201447   | EP232848 (P-144-24) |        |            |
| 1.442                         | 1.754 | 3/4    | 401450   | SS-4656-12          |        |            |
|                               |       | 1      | 401451   | SS-4656-16          |        |            |
|                               |       | 1-1/4  | 401452   | SS-4656-20          |        |            |
|                               |       | 1-1/2  | 401453   | SS-4656-24          |        |            |
|                               |       | 1-3/4  | 401454   | SS-4656-28          |        |            |
|                               |       | 2      | 401455   | SS-4656-32          |        |            |
|                               |       | 2-1/2  | 401456   | SS-4656-40          |        |            |
|                               |       | 3      | 401457   | SS-4656-48          |        |            |
|                               |       | 1.4425 | 1.7535   | 7/8                 | 101691 | AA-1703-1  |
|                               |       |        |          | 1-1/8               | 101692 | AA-1703-14 |
|                               |       | 1-1/4  | 101693   | AA-1703-4           |        |            |
|                               |       | 1-1/2  | 101694   | AA-1703-6           |        |            |

| ID                             | OD     | LGTH. | ITEM NO. | PART NO.            |
|--------------------------------|--------|-------|----------|---------------------|
| 1.4425                         | 1.7535 | 1-3/4 | 101695   | AA-1703-3           |
|                                |        | 1-7/8 | 101696   | AA-1703             |
|                                |        | 2     | 101697   | AA-1703-7           |
|                                |        | 2-1/4 | 101698   | AA-1703-10          |
|                                |        | 2-1/2 | 101699   | AA-1703-5           |
| <b>1-1/2 X 1-11/16 NOMINAL</b> |        |       |          |                     |
| 1.507                          | 1.691  | 3/4   | 101700   | AA-1612-4           |
|                                |        | 1     | 101701   | AA-1612-1           |
| <b>1-1/2 X 1-3/4 NOMINAL</b>   |        |       |          |                     |
| 1.503                          | 1.753  | 1     | 301380   | B-2428-8            |
|                                |        | 1-1/4 | 301381   | B-2428-10           |
|                                |        | 1-1/2 | 301382   | B-2428-12           |
|                                |        | 2     | 301383   | B-2428-16           |
|                                |        | 2-1/2 | 301384   | B-2428-20           |
|                                |        | 3     | 301385   | B-2428-24           |
| 1.503                          | 1.754  | 1/2   | 101702   | AA-1704-20          |
|                                |        | 5/8   | 101703   | AA-1704-21          |
|                                |        | 3/4   | 101704   | AA-1704-16          |
|                                |        | 7/8   | 101705   | AA-1704-4           |
|                                |        | 1     | 101706   | AA-1704-15          |
|                                |        | 1-1/8 | 101707   | AA-1704-17          |
|                                |        | 1-1/4 | 101708   | AA-1704-11          |
|                                |        | 1-3/8 | 101709   | AA-1704-5           |
|                                |        | 1-1/2 | 101710   | AA-1704             |
|                                |        | 1-3/4 | 101711   | AA-1704-3           |
|                                |        | 2     | 101712   | AA-1704-2           |
|                                |        | 2-1/4 | 101713   | AA-1704-7           |
|                                |        | 2-1/2 | 101714   | AA-1704-8           |
|                                |        | 3     | 101715   | AA-1704-9           |
|                                |        | 3-1/2 | 101716   | AA-1704-19          |
| 1.504                          | 1.754  | 1/2   | 401458   | SS-4856-8           |
|                                |        | 3/4   | 401459   | SS-4856-12          |
|                                |        | 1     | 401460   | SS-4856-16          |
|                                |        | 1-1/4 | 401461   | SS-4856-20          |
|                                |        | 1-3/8 | 401462   | SS-4856-22          |
|                                |        | 1-1/2 | 401463   | SS-4856-24          |
|                                |        | 1-3/4 | 401464   | SS-4856-28          |
|                                |        | 2     | 401465   | SS-4856-32          |
|                                |        | 2-1/4 | 401466   | SS-4856-36          |
|                                |        | 2-1/2 | 401467   | SS-4856-40          |
|                                |        | 3     | 401468   | SS-4856-48          |
| 1.504                          | 1.755  | 1/2   | 201580   | EP242808 (P-150-4)  |
|                                |        | 5/8   | 201581   | EP242810 (P-150-5)  |
|                                |        | 3/4   | 201448   | EP242812 (P-150-6)  |
|                                |        | 7/8   | 201449   | EP242814 (P-150-7)  |
|                                |        | 1     | 201450   | EP242816 (P-150-8)  |
|                                |        | 1-1/4 | 201451   | EP242820 (P-150-10) |
|                                |        | 1-3/8 | 201452   | EP242822 (P-150-11) |
|                                |        | 1-1/2 | 201453   | EP242824 (P-150-12) |
|                                |        | 1-3/4 | 201454   | EP242828 (P-150-14) |
|                                |        | 2     | 201455   | EP242832 (P-150-16) |

\*Other sizes, tolerances, lubricants and materials are available on special orders.



| ID                                   | OD     | LGTH. | ITEM NO. | PART NO.            |
|--------------------------------------|--------|-------|----------|---------------------|
| <b>1-1/2 X 1-3/4 NOMINAL (cont.)</b> |        |       |          |                     |
| 1.504                                | 1.755  | 2-1/4 | 201456   | EP242836 (P-150-18) |
|                                      |        | 2-1/2 | 201457   | EP242840 (P-150-20) |
|                                      |        | 3     | 201458   | EP242848 (P-150-24) |
| <b>1-1/2 X 1-13/16 NOMINAL</b>       |        |       |          |                     |
| 1.502                                | 1.815  | 1     | 101717   | AA-1801-1           |
|                                      |        | 1-5/8 | 101718   | AA-1801             |
| 1.503                                | 1.816  | 1-1/2 | 301386   | B-2429-12           |
|                                      |        | 3     | 301387   | B-2429-24           |
| 1.504                                | 1.816  | 1     | 401469   | SS-4858-16          |
|                                      |        | 1-1/2 | 401470   | SS-4858-24          |
|                                      |        | 1-5/8 | 401471   | SS-4858-26          |
|                                      |        | 2     | 401472   | SS-4858-32          |
|                                      |        | 3     | 401473   | SS-4858-48          |
| 1.504                                | 1.8175 | 1     | 201459   | EP242916 (P-151-8)  |
|                                      |        | 1-1/2 | 201460   | EP242924 (P-151-12) |
|                                      |        | 1-5/8 | 201461   | EP242926 (P-151-13) |
|                                      |        | 3     | 201462   | EP242948 (P-151-24) |
| <b>1-1/2 X 1-7/8 NOMINAL</b>         |        |       |          |                     |
| 1.503                                | 1.878  | 1-1/2 | 101719   | AA-1807-9           |
|                                      |        | 1-3/4 | 101720   | AA-1807-10          |
|                                      |        | 2     | 101721   | AA-1807             |
|                                      |        | 2-1/2 | 101722   | AA-1807-11          |
|                                      |        | 2-3/4 | 101723   | AA-1807-1           |
|                                      |        | 3     | 101724   | AA-1807-2           |
| 1.503                                | 1.878  | 1-1/2 | 301388   | B-2430-12           |
|                                      |        | 2     | 301389   | B-2430-16           |
|                                      |        | 2-1/2 | 301390   | B-2430-20           |
|                                      |        | 3     | 301391   | B-2430-24           |
| 1.504                                | 1.880  | 1-1/2 | 201463   | EP243024 (P-152-12) |
|                                      |        | 2     | 201464   | EP243032 (P-152-16) |
|                                      |        | 2-1/2 | 201465   | EP243040 (P-152-20) |
|                                      |        | 2-3/4 | 201466   | EP243044 (P-152-22) |
|                                      |        | 3     | 201467   | EP243048 (P-152-24) |
| 1.504                                | 1.879  | 1-1/2 | 401474   | SS-4860-24          |
|                                      |        | 2     | 401475   | SS-4860-32          |
|                                      |        | 2-1/2 | 401476   | SS-4860-40          |
|                                      |        | 2-3/4 | 401477   | SS-4860-44          |
|                                      |        | 3     | 401478   | SS-4860-48          |
| <b>1-1/2 X 2 NOMINAL</b>             |        |       |          |                     |
| 1.503                                | 2.004  | 1     | 101725   | AA-2007-6           |
|                                      |        | 2     | 101726   | AA-2007-2           |
|                                      |        | 2-1/2 | 101727   | AA-2007-3           |
|                                      |        | 3-1/2 | 101728   | AA-2007-5           |
| 1.503                                | 2.004  | 1     | 301392   | B-2432-8            |
|                                      |        | 1-1/2 | 301447   | B-2432-12           |
|                                      |        | 2     | 301393   | B-2432-16           |
|                                      |        | 2-1/2 | 301394   | B-2432-20           |
|                                      |        | 3     | 301395   | B-2432-24           |
| 1.504                                | 2.004  | 1     | 401479   | SS-4864-16          |
|                                      |        | 1-1/2 | 401480   | SS-4864-24          |
|                                      |        | 2     | 401481   | SS-4864-32          |

| ID                           | OD    | LGTH. | ITEM NO. | PART NO.            |
|------------------------------|-------|-------|----------|---------------------|
| 1.504                        | 2.004 | 2-1/2 | 401482   | SS-4864-40          |
|                              |       | 3     | 401483   | SS-4864-48          |
|                              |       | 3-1/2 | 401484   | SS-4864-56          |
| 1.504                        | 2.005 | 1     | 201468   | EP243216 (P-153-8)  |
|                              |       | 1-1/2 | 201469   | EP243224 (P-153-12) |
|                              |       | 2     | 201470   | EP243232 (P-153-16) |
|                              |       | 2-1/2 | 201471   | EP243240 (P-153-20) |
|                              |       | 3     | 201472   | EP243248 (P-153-24) |
|                              |       | 3-1/2 | 201473   | EP243256 (P-153-28) |
| <b>1-5/8 X 1-7/8 NOMINAL</b> |       |       |          |                     |
| 1.627                        | 1.879 | 1     | 101729   | AA-1803-10          |
|                              |       | 1-1/4 | 101730   | AA-1803-11          |
|                              |       | 1-1/2 | 101731   | AA-1803-13          |
|                              |       | 1-3/4 | 101732   | AA-1803-14          |
|                              |       | 2     | 101733   | AA-1803-7           |
|                              |       | 2-1/4 | 101734   | AA-1803-1           |
|                              |       | 2-3/4 | 101735   | AA-1803-15          |
| 1.628                        | 1.878 | 1-1/4 | 301396   | B-2630-10           |
|                              |       | 1-1/2 | 301397   | B-2630-12           |
|                              |       | 2     | 301398   | B-2630-16           |
|                              |       | 2-1/2 | 301399   | B-2630-20           |
|                              |       | 3     | 301400   | B-2630-24           |
| 1.629                        | 1.879 | 1-1/4 | 401485   | SS-5260-20          |
|                              |       | 1-1/2 | 401486   | SS-5260-24          |
|                              |       | 1-3/4 | 401487   | SS-5260-28          |
|                              |       | 2     | 401488   | SS-5260-32          |
|                              |       | 2-1/4 | 401489   | SS-5260-36          |
|                              |       | 2-1/2 | 401490   | SS-5260-40          |
|                              |       | 3     | 401491   | SS-5260-48          |
| 1.629                        | 1.880 | 1-1/4 | 201474   | EP263020 (P-162-10) |
|                              |       | 1-1/2 | 201475   | EP263024 (P-162-12) |
|                              |       | 1-3/4 | 201476   | EP263028 (P-162-14) |
|                              |       | 2     | 201477   | EP263032 (P-162-16) |
|                              |       | 2-1/4 | 201478   | EP263036 (P-162-18) |
|                              |       | 2-1/2 | 201479   | EP263040 (P-162-20) |
|                              |       | 3     | 201480   | EP263048 (P-162-24) |
| <b>1-5/8 X 2 NOMINAL</b>     |       |       |          |                     |
| 1.6265                       | 2.004 | 1-1/2 | 101736   | AA-2000-5           |
|                              |       | 2     | 101737   | AA-2000-1           |
|                              |       | 2-1/2 | 101738   | AA-2000-3           |
|                              |       | 3     | 101739   | AA-2000-4           |
| 1.628                        | 2.004 | 1     | 301401   | B-2632-8            |
|                              |       | 1-1/2 | 301402   | B-2632-12           |
|                              |       | 2     | 301403   | B-2632-16           |
|                              |       | 3     | 301404   | B-2632-24           |
| 1.629                        | 2.004 | 1     | 401492   | SS-5264-16          |
|                              |       | 1-1/2 | 401493   | SS-5264-24          |
|                              |       | 1-3/4 | 401494   | SS-5264-28          |
|                              |       | 2     | 401495   | SS-5264-32          |
|                              |       | 2-1/2 | 401496   | SS-5264-40          |
|                              |       | 3     | 401497   | SS-5264-48          |

| ID                              | OD     | LGTH. | ITEM NO. | PART NO.            |
|---------------------------------|--------|-------|----------|---------------------|
| 1.629                           | 2.005  | 1     | 201481   | EP263216 (P-163-8)  |
|                                 |        | 1-1/2 | 201482   | EP263224 (P-163-12) |
|                                 |        | 2     | 201483   | EP263232 (P-163-16) |
|                                 |        | 2-1/2 | 201484   | EP263240 (P-163-20) |
|                                 |        | 3     | 201485   | EP263248 (P-163-24) |
| <b>1-11/16 X 2-3/16 NOMINAL</b> |        |       |          |                     |
| 1.6905                          | 2.191  | 1-3/4 | 301405   | B-2735-14           |
|                                 |        | 2     | 301406   | B-2735-16           |
|                                 |        | 3     | 301407   | B-2735-24           |
|                                 |        | 4     | 301408   | B-2735-32           |
| 1.6905                          | 2.1915 | 2     | 101740   | AA-2107-1           |
|                                 |        | 4     | 101741   | AA-2107             |
| 1.6915                          | 2.1925 | 1-3/4 | 201486   | EP273528 (P-168-14) |
|                                 |        | 2     | 201487   | EP273532 (P-168-16) |
|                                 |        | 3     | 201488   | EP273548 (P-168-24) |
|                                 |        | 4     | 201489   | EP273564 (P-168-32) |
| 1.6915                          | 2.1925 | 1-3/4 | 401498   | SS-5470-28          |
|                                 |        | 2     | 401499   | SS-5470-32          |
|                                 |        | 3     | 401500   | SS-5470-48          |
|                                 |        | 4     | 401501   | SS-5470-64          |
| <b>1-3/4 X 1-15/16 NOMINAL</b>  |        |       |          |                     |
| 1.7525                          | 1.9415 | 1-1/4 | 101742   | AA-1904-2           |
|                                 |        | 1-1/2 | 101743   | AA-1904-3           |
| <b>1-3/4 X 2 NOMINAL</b>        |        |       |          |                     |
| 1.753                           | 2.004  | 1     | 101744   | AA-2001-11          |
|                                 |        | 1-1/2 | 101745   | AA-2001-3           |
|                                 |        | 1-7/8 | 101746   | AA-2001             |
|                                 |        | 2     | 101747   | AA-2001-9           |
|                                 |        | 2-1/2 | 101748   | AA-2001-1           |
|                                 |        | 2-3/4 | 101749   | AA-2001-13          |
|                                 |        | 3     | 101750   | AA-2001-2           |
| 1.753                           | 2.004  | 2     | 301409   | B-2832-16           |
|                                 |        | 2-1/2 | 301410   | B-2832-20           |
|                                 |        | 3     | 301411   | B-2832-24           |
| 1.754                           | 2.004  | 1     | 401502   | SS-5664-16          |
|                                 |        | 1-1/4 | 401503   | SS-5664-20          |
|                                 |        | 1-1/2 | 401504   | SS-5664-24          |
|                                 |        | 1-3/4 | 401505   | SS-5664-28          |
|                                 |        | 2     | 401506   | SS-5664-32          |
|                                 |        | 2-1/2 | 401507   | SS-5664-40          |
|                                 |        | 3     | 401508   | SS-5664-48          |
| 1.754                           | 2.005  | 1     | 201490   | EP283216 (P-175-8)  |
|                                 |        | 1-1/4 | 201491   | EP283220 (P-175-10) |
|                                 |        | 1-1/2 | 201492   | EP283224 (P-175-12) |
|                                 |        | 1-3/4 | 201493   | EP283228 (P-175-14) |
|                                 |        | 2     | 201494   | EP283232 (P-175-16) |
|                                 |        | 2-1/2 | 201495   | EP283240 (P-175-20) |
|                                 |        | 3     | 201496   | EP283248 (P-175-24) |
| <b>1-3/4 X 2-1/8 NOMINAL</b>    |        |       |          |                     |
| 1.753                           | 2.129  | 1-1/2 | 301412   | B-2834-12           |
|                                 |        | 2     | 301413   | B-2834-16           |
|                                 |        | 3     | 301414   | B-2834-24           |



| ID                                   | OD     | LGTH. | ITEM NO. | PART NO.            |
|--------------------------------------|--------|-------|----------|---------------------|
| <b>1-3/4 X 2-1/8 NOMINAL (cont.)</b> |        |       |          |                     |
| 1.754                                | 2.128  | 1/2   | 101751   | AA-2112-8           |
|                                      |        | 1-1/2 | 101752   | AA-2112-1           |
|                                      |        | 2     | 101753   | AA-2112-2           |
|                                      |        | 2-1/2 | 101754   | AA-2112-3           |
| 1.754                                | 2.129  | 1-3/8 | 401509   | SS-5668-22          |
|                                      |        | 1-1/2 | 401510   | SS-5668-24          |
|                                      |        | 2     | 401511   | SS-5668-32          |
|                                      |        | 3     | 401512   | SS-5668-48          |
| 1.754                                | 2.130  | 1-1/2 | 201497   | EP283424 (P-176-12) |
|                                      |        | 2     | 201498   | EP283432 (P-176-16) |
|                                      |        | 3     | 201499   | EP283448 (P-176-24) |
| <b>1-3/4 X 2-1/4 NOMINAL</b>         |        |       |          |                     |
| 1.753                                | 2.253  | 2     | 101755   | AA-2204-2           |
|                                      |        | 2-1/2 | 101756   | AA-2204-3           |
|                                      |        | 3     | 101757   | AA-2204             |
| <b>1-7/8 X 2-1/4 NOMINAL</b>         |        |       |          |                     |
| 1.878                                | 2.254  | 3/4   | 101758   | AA-2202-10          |
|                                      |        | 2     | 101759   | AA-2202             |
|                                      |        | 2-1/2 | 101760   | AA-2202-1           |
|                                      |        | 3     | 101761   | AA-2202-2           |
| <b>1-15/16 X 2-1/8 NOMINAL</b>       |        |       |          |                     |
| 1.940                                | 2.1285 | 2     | 101762   | AA-2102-3           |
|                                      |        | 2-1/2 | 101763   | AA-2102-1           |
| 1.940                                | 2.1285 | 2-1/2 | 401513   | SS-6268-40          |
| <b>1-15/16 X 2-5/16 NOMINAL</b>      |        |       |          |                     |
| 1.9405                               | 2.316  | 2     | 301415   | B-3137-16           |
|                                      |        | 3     | 301416   | B-3137-24           |
|                                      |        | 4     | 301417   | B-3137-32           |
| 1.9405                               | 2.3165 | 2     | 101764   | AA-2306-3           |
|                                      |        | 3     | 101765   | AA-2306-5           |
|                                      |        | 4     | 101766   | AA-2306             |
| 1.9405                               | 2.3165 | 2     | 401514   | SS-6274-32          |
|                                      |        | 2-1/2 | 401515   | SS-6274-40          |
|                                      |        | 3     | 401516   | SS-6274-48          |
|                                      |        | 4     | 401517   | SS-6274-64          |
| 1.9415                               | 2.3175 | 2     | 201500   | EP313732 (P-193-16) |
|                                      |        | 2-1/2 | 201501   | EP313740 (P-193-20) |
|                                      |        | 3     | 201502   | EP313748 (P-193-24) |
|                                      |        | 4     | 201503   | EP313764 (P-193-32) |
| <b>1-15/16 X 2-7/16 NOMINAL</b>      |        |       |          |                     |
| 1.942                                | 2.4415 | 1-1/2 | 101767   | AA-2403-1           |
|                                      |        | 2     | 101768   | AA-2403-2           |
| <b>2 X 2-1/4 NOMINAL</b>             |        |       |          |                     |
| 2.003                                | 2.254  | 3/4   | 101769   | AA-2203-5           |
|                                      |        | 1     | 101770   | AA-2203-6           |
|                                      |        | 1-1/2 | 101771   | AA-2203-7           |

| ID                       | OD    | LGTH. | ITEM NO. | PART NO.            |
|--------------------------|-------|-------|----------|---------------------|
| 2.003                    | 2.254 | 2     | 101772   | AA-2203             |
|                          |       | 2-1/2 | 101773   | AA-2203-9           |
|                          |       | 3     | 101774   | AA-2203-10          |
| 2.004                    | 2.254 | 1     | 401518   | SS-6472-16          |
|                          |       | 1-1/2 | 401519   | SS-6472-24          |
|                          |       | 2     | 401520   | SS-6472-32          |
|                          |       | 2-1/2 | 401521   | SS-6472-40          |
|                          |       | 3     | 401522   | SS-6472-48          |
| 2.004                    | 2.255 | 3/4   | 201582   | EP323612 (P-200-6)  |
|                          |       | 1     | 201504   | EP323616 (P-200-8)  |
|                          |       | 1-1/2 | 201505   | EP323624 (P-200-12) |
|                          |       | 2     | 201506   | EP323632 (P-200-16) |
|                          |       | 2-1/2 | 201507   | EP323640 (P-200-20) |
|                          |       | 3     | 201508   | EP323648 (P-200-24) |
| <b>2 X 2-3/8 NOMINAL</b> |       |       |          |                     |
| 2.003                    | 2.379 | 1-1/8 | 101775   | AA-2304-6           |
|                          |       | 1-1/2 | 101776   | AA-2304-7           |
|                          |       | 1-3/4 | 101777   | AA-2304             |
|                          |       | 2     | 101778   | AA-2304-1           |
|                          |       | 2-1/2 | 101779   | AA-2304-2           |
|                          |       | 3     | 101780   | AA-2304-3           |
|                          |       | 3-1/2 | 101781   | AA-2304-4           |
|                          |       | 4     | 101782   | AA-2304-5           |
| 2.003                    | 2.379 | 1-3/4 | 301418   | B-3238-14           |
|                          |       | 2     | 301419   | B-3238-16           |
|                          |       | 2-3/4 | 301420   | B-3238-22           |
|                          |       | 3     | 301421   | B-3238-24           |
|                          |       | 4     | 301422   | B-3238-32           |
| 2.004                    | 2.380 | 1-1/8 | 201583   | EP323818 (P-201-9)  |
|                          |       | 1-1/2 | 201509   | EP323824 (P-201-12) |
|                          |       | 1-3/4 | 201510   | EP323828 (P-201-14) |
|                          |       | 2     | 201511   | EP323832 (P-201-16) |
|                          |       | 2-1/2 | 201512   | EP323840 (P-201-20) |
|                          |       | 2-3/4 | 201513   | EP323844 (P-201-22) |
|                          |       | 3     | 201514   | EP323848 (P-201-24) |
|                          |       | 3-1/2 | 201515   | EP323856 (P-201-28) |
|                          |       | 4     | 201516   | EP323864 (P-201-32) |
| 2.004                    | 2.380 | 1-1/2 | 401523   | SS-6476-24          |
|                          |       | 1-3/4 | 401524   | SS-6476-28          |
|                          |       | 2     | 401525   | SS-6476-32          |
|                          |       | 2-1/2 | 401526   | SS-6476-40          |
|                          |       | 2-3/4 | 401527   | SS-6476-44          |
|                          |       | 3     | 401528   | SS-6476-48          |
|                          |       | 3-1/2 | 401529   | SS-6476-56          |
|                          |       | 4     | 401530   | SS-6476-64          |
| <b>2 X 2-1/2 NOMINAL</b> |       |       |          |                     |
| 2.003                    | 2.503 | 1-1/2 | 101783   | AA-2501-1           |
|                          |       | 2     | 101784   | AA-2501-2           |
|                          |       | 2-1/2 | 101785   | AA-2501-3           |
|                          |       | 3     | 101786   | AA-2501             |

| ID                            | OD     | LGTH. | ITEM NO. | PART NO.            |
|-------------------------------|--------|-------|----------|---------------------|
| 2.004                         | 2.504  | 1     | 301423   | B-3240-8            |
|                               |        | 2     | 301424   | B-3240-16           |
|                               |        | 3     | 301425   | B-3240-24           |
| 2.004                         | 2.505  | 1     | 201517   | EP324016 (P-202-8)  |
|                               |        | 1-1/2 | 201518   | EP324024 (P-202-12) |
|                               |        | 2     | 201519   | EP324032 (P-202-16) |
|                               |        | 2-1/2 | 201520   | EP324040 (P-202-20) |
|                               |        | 3     | 201521   | EP324048 (P-202-24) |
|                               |        | 3-1/2 | 201522   | EP324056 (P-202-28) |
|                               |        | 4     | 201523   | EP324064 (P-202-32) |
| 2.004                         | 2.505  | 1     | 401531   | SS-6480-16          |
|                               |        | 1-1/2 | 401532   | SS-6480-24          |
|                               |        | 2     | 401533   | SS-6480-32          |
|                               |        | 2-1/2 | 401534   | SS-6480-40          |
|                               |        | 3     | 401535   | SS-6480-48          |
|                               |        | 3-1/2 | 401536   | SS-6480-56          |
|                               |        | 4     | 401537   | SS-6480-64          |
| <b>2-3/16 X 2-3/8 NOMINAL</b> |        |       |          |                     |
| 2.190                         | 2.379  | 1-1/2 | 101787   | AA-2303-1           |
| <b>2-1/4 X 2-5/8 NOMINAL</b>  |        |       |          |                     |
| 2.254                         | 2.6295 | 2     | 101788   | AA-2605-3           |
|                               |        | 3     | 101789   | AA-2605-5           |
|                               |        | 3-1/2 | 101790   | AA-2605             |
|                               |        | 4-1/2 | 101791   | AA-2605-2           |
| 2.254                         | 2.630  | 2     | 401538   | SS-7284-32          |
|                               |        | 2-1/2 | 401539   | SS-7284-40          |
|                               |        | 3     | 401540   | SS-7284-48          |
| 2.254                         | 2.631  | 2     | 201524   | EP364232 (P-225-16) |
|                               |        | 2-1/2 | 201525   | EP364240 (P-225-20) |
|                               |        | 3     | 201526   | EP364248 (P-225-24) |
| <b>2-1/4 X 2-3/4 NOMINAL</b>  |        |       |          |                     |
| 2.253                         | 2.753  | 1-1/2 | 101792   | AA-2703-1           |
|                               |        | 2     | 101793   | AA-2703-2           |
|                               |        | 3     | 101794   | AA-2703             |
| 2.254                         | 2.754  | 2     | 301429   | B-3644-16           |
|                               |        | 3     | 301430   | B-3644-24           |
| 2.254                         | 2.755  | 2     | 401541   | SS-7288-32          |
|                               |        | 3     | 401542   | SS-7288-48          |
| 2.254                         | 2.756  | 2     | 201527   | EP364432 (P-226-16) |
|                               |        | 3     | 201528   | EP364448 (P-226-24) |
| <b>2-3/8 X 2-5/8 NOMINAL</b>  |        |       |          |                     |
| 2.377                         | 2.6295 | 1-1/4 | 101795   | AA-2602-3           |
|                               |        | 1-5/8 | 101796   | AA-2602             |
| <b>2-3/8 X 2-3/4 NOMINAL</b>  |        |       |          |                     |
| 2.379                         | 2.753  | 2     | 101797   | AA-2701-2           |
|                               |        | 2-1/2 | 101798   | AA-2701-6           |
|                               |        | 3     | 101799   | AA-2701             |
| 2.379                         | 2.754  | 2     | 301432   | B-3844-16           |
|                               |        | 3     | 301433   | B-3844-24           |
| 2.379                         | 2.755  | 2     | 401543   | SS-7688-32          |
|                               |        | 2-1/2 | 401544   | SS-7688-40          |
|                               |        | 3     | 401545   | SS-7688-48          |
| 2.379                         | 2.756  | 2     | 201529   | EP384432 (P-237-16) |
|                               |        | 2-1/2 | 201530   | EP384440 (P-237-20) |
|                               |        | 3     | 201531   | EP384448 (P-237-24) |

\*Other sizes, tolerances, lubricants and materials are available on special orders.





| ID                           | OD    | LGTH. | ITEM NO. | PART NO.            |
|------------------------------|-------|-------|----------|---------------------|
| <b>2-1/2 X 2-3/4 NOMINAL</b> |       |       |          |                     |
| 2.504                        | 2.754 | 2     | 401546   | SS-8088-32          |
|                              |       | 2-1/2 | 401547   | SS-8088-40          |
|                              |       | 3     | 401548   | SS-8088-48          |
|                              |       | 4     | 401549   | SS-8088-64          |
| 2.505                        | 2.754 | 2     | 101800   | AA-2702-5           |
|                              |       | 2-1/2 | 101801   | AA-2702-4           |
|                              |       | 3     | 101802   | AA-2702-1           |
| 2.505                        | 2.756 | 2     | 201532   | EP404432 (P-250-16) |
|                              |       | 3     | 201533   | EP404448 (P-250-24) |
|                              |       | 4     | 201534   | EP404464 (P-250-32) |
| <b>2-1/2 X 2-7/8 NOMINAL</b> |       |       |          |                     |
| 2.504                        | 2.880 | 2-1/4 | 101803   | AA-2803-1           |
|                              |       | 2-1/2 | 101804   | AA-2803-3           |
|                              |       | 3     | 101805   | AA-2803-2           |
| 2.504                        | 2.880 | 2-1/4 | 401550   | SS-8092-36          |
|                              |       | 2-1/2 | 401551   | SS-8092-40          |
|                              |       | 3     | 401552   | SS-8092-48          |
| 2.505                        | 2.881 | 2-1/4 | 201535   | EP404636 (P-251-18) |
|                              |       | 2-1/2 | 201536   | EP404640 (P-251-20) |
|                              |       | 3     | 201537   | EP404648 (P-251-24) |
| <b>2-1/2 X 3 NOMINAL</b>     |       |       |          |                     |
| 2.504                        | 3.005 | 2     | 101806   | AA-3005-7           |
|                              |       | 2-1/2 | 101807   | AA-3005-4           |
|                              |       | 3     | 101808   | AA-3005-1           |
|                              |       | 4     | 101809   | AA-3005             |
| 2.504                        | 3.005 | 2     | 301438   | B-4048-16           |
|                              |       | 3     | 301439   | B-4048-24           |
|                              |       | 4     | 301440   | B-4048-32           |
| 2.504                        | 3.005 | 2     | 401553   | SS-8096-32          |
|                              |       | 3     | 401554   | SS-8096-48          |
|                              |       | 4     | 401555   | SS-8096-64          |
| 2.505                        | 3.006 | 2     | 201538   | EP404832 (P-252-16) |
|                              |       | 3     | 201539   | EP404848 (P-252-24) |
|                              |       | 4     | 201540   | EP404864 (P-252-32) |
| <b>2-3/4 X 3 NOMINAL</b>     |       |       |          |                     |
| 2.753                        | 3.005 | 1-1/2 | 101810   | AA-3006-1           |
|                              |       | 2-1/2 | 101811   | AA-3006             |
| 2.754                        | 3.005 | 1-1/2 | 401556   | SS-8896-24          |
|                              |       | 2-1/2 | 401557   | SS-8896-40          |
| <b>2-3/4 X 3-1/8 NOMINAL</b> |       |       |          |                     |
| 2.753                        | 3.129 | 1-1/4 | 101812   | AA-3100-7           |
|                              |       | 2-3/4 | 101813   | AA-3100             |
|                              |       | 4     | 101814   | AA-3100-11          |
| <b>2-3/4 X 3-1/4 NOMINAL</b> |       |       |          |                     |
| 2.752                        | 3.254 | 1-1/2 | 101815   | AA-3201-1           |
|                              |       | 2     | 101816   | AA-3201-4           |
|                              |       | 3     | 101817   | AA-3201-7           |
|                              |       | 4     | 101818   | AA-3201             |

| ID                              | OD    | LGTH. | ITEM NO. | PART NO.            |
|---------------------------------|-------|-------|----------|---------------------|
| 2.754                           | 3.255 | 2     | 401558   | SS-88104-32         |
|                                 |       | 3     | 401559   | SS-88104-48         |
|                                 |       | 4     | 401560   | SS-88104-64         |
| 2.755                           | 3.255 | 2     | 301441   | B-4452-16           |
|                                 |       | 3     | 301442   | B-4452-24           |
|                                 |       | 4     | 301443   | B-4452-32           |
| 2.755                           | 3.257 | 2     | 201541   | EP445232 (P-275-16) |
|                                 |       | 3     | 201542   | EP445248 (P-275-24) |
|                                 |       | 4     | 201543   | EP445264 (P-275-32) |
| <b>2-15/16 X 3-5/16 NOMINAL</b> |       |       |          |                     |
| 2.940                           | 3.315 | 3     | 401561   | SS-94106-48         |
|                                 |       | 3     | 101819   | AA-3301-3           |
| <b>3 X 3-1/4 NOMINAL</b>        |       |       |          |                     |
| 3.002                           | 3.255 | 1-1/4 | 101820   | AA-3200-5           |
|                                 |       | 2     | 101821   | AA-3200             |
|                                 |       | 3     | 101822   | AA-3200-2           |
| 3.005                           | 3.255 | 2     | 401562   | SS-96104-32         |
|                                 |       | 3     | 401563   | SS-96104-48         |
| 3.006                           | 3.257 | 2     | 201544   | EP485232 (P-300-16) |
|                                 |       | 3     | 201545   | EP485248 (P-300-24) |
| <b>3 X 3-1/2 NOMINAL</b>        |       |       |          |                     |
| 3.004                           | 3.505 | 2-1/2 | 101823   | AA-3502-7           |
|                                 |       | 3     | 101824   | AA-3502-8           |
|                                 |       | 4     | 101825   | AA-3502-3           |
| 3.004                           | 3.505 | 2     | 301444   | B-4856-16           |
|                                 |       | 3     | 301445   | B-4856-24           |
|                                 |       | 4     | 301446   | B-4856-32           |
| 3.005                           | 3.505 | 2     | 401564   | SS-96112-32         |
|                                 |       | 2-1/2 | 401565   | SS-96112-40         |
|                                 |       | 3     | 401566   | SS-96112-48         |
|                                 |       | 4     | 401567   | SS-96112-64         |
| 3.006                           | 3.507 | 2     | 201546   | EP485632 (P-301-16) |
|                                 |       | 2-1/2 | 201547   | EP485640 (P-301-20) |
|                                 |       | 3     | 201548   | EP485648 (P-301-24) |
|                                 |       | 4     | 201549   | EP485664 (P-301-32) |
| <b>3-1/4 X 3-5/8 NOMINAL</b>    |       |       |          |                     |
| 3.253                           | 3.628 | 4     | 101826   | AA-3600-5           |
| 3.253                           | 3.628 | 4     | 401568   | SS-104116-64        |
| <b>3-1/2 X 4 NOMINAL</b>        |       |       |          |                     |
| 3.5035                          | 4.004 | 2     | 101827   | AA-4000-3           |
|                                 |       | 3     | 101828   | AA-4000-5           |
|                                 |       | 3-1/2 | 101829   | AA-4000-6           |
|                                 |       | 4     | 101830   | AA-4000             |
| 3.505                           | 4.006 | 3     | 401569   | SS-112128-48        |
|                                 |       | 3-1/2 | 401570   | SS-112128-56        |
|                                 |       | 4     | 401571   | SS-112128-64        |

| ID                           | OD     | LGTH. | ITEM NO. | PART NO.            |
|------------------------------|--------|-------|----------|---------------------|
| 3.507                        | 4.008  | 2     | 201584   | EP566432 (P-350-16) |
|                              |        | 3     | 201550   | EP566448 (P-350-24) |
|                              |        | 3-1/2 | 201551   | EP566456 (P-350-28) |
|                              |        | 4     | 201552   | EP566464 (P-350-32) |
| <b>4 X 4-1/2 NOMINAL</b>     |        |       |          |                     |
| 4.0035                       | 4.504  | 4     | 101831   | AA-4500             |
|                              |        | 6     | 101832   | AA-4500-2           |
| 4.0035                       | 4.504  | 4     | 401572   | SS-128144-64        |
|                              |        | 6     | 401573   | SS-128144-96        |
| 4.008                        | 4.509  | 4     | 201553   | EP647264 (P-400-32) |
| <b>4 X 4-5/8 NOMINAL</b>     |        |       |          |                     |
| 4.003                        | 4.628  | 4     | 101833   | AA-4600-5           |
| 4.003                        | 4.628  | 4     | 401574   | SS-128148-64        |
| <b>4-1/2 X 5-1/4 NOMINAL</b> |        |       |          |                     |
| 4.504                        | 5.2545 | 5     | 101834   | AA-5201             |
| 4.504                        | 5.2545 | 5     | 401575   | SS-144168-80        |
| <b>5 X 5-3/4 NOMINAL</b>     |        |       |          |                     |
| 5.004                        | 5.755  | 2     | 101835   | AA-5700-1           |
| 5.004                        | 5.755  | 2     | 401576   | SS-160184-32        |

\*Other sizes, tolerances, lubricants and materials are available on special orders.



| DEC. I.D.                  | DEC. O.D. | NOM. LGTH.                                                 | FLG. O.D. | FLG. THICK | ITEM. NO.                                                                    | PART. NO.                                                                                                      |
|----------------------------|-----------|------------------------------------------------------------|-----------|------------|------------------------------------------------------------------------------|----------------------------------------------------------------------------------------------------------------|
| <b>1/8 X 1/4 NOMINAL</b>   |           |                                                            |           |            |                                                                              |                                                                                                                |
| .126                       | .252      | 1/4<br>3/8                                                 | 5/16      | 1/16       | 102001<br>102002                                                             | FF-207-2<br>FF-207-3                                                                                           |
| <b>1/8 X 5/16 NOMINAL</b>  |           |                                                            |           |            |                                                                              |                                                                                                                |
| .127                       | .315      | 1/4<br>3/8                                                 | 3/8       | 3/64       | 302001<br>302002                                                             | FB-25-2<br>FB-25-3                                                                                             |
| <b>3/16 X 5/16 NOMINAL</b> |           |                                                            |           |            |                                                                              |                                                                                                                |
| .187                       | .313      | 1/4<br>3/8                                                 | 3/8       | 1/16       | 102003<br>102004                                                             | FF-313-1<br>FF-313-2                                                                                           |
| .189                       | .3145     | 1/8<br>1/4<br>3/8                                          | 3/8       | 3/64       | 302003<br>302004<br>302005                                                   | FB-35-1<br>FB-35-2<br>FB-35-3                                                                                  |
| .1895                      | .314      | 3/16<br>1/4<br>5/16<br>3/8<br>1/2                          | 7/16      | 1/16       | 102005<br>102006<br>102007<br>102008<br>102009                               | FF-303-1<br>FF-303-3<br>FF-303-2<br>FF-303<br>FF-303-4                                                         |
| .1895                      | .314      | 3/16<br>1/4<br>5/16<br>3/8<br>1/2                          | 7/16      | 1/16       | 402001<br>402002<br>402003<br>402004<br>402005                               | SF-610-3<br>SF-610-4<br>SF-610-5<br>SF-610-6<br>SF-610-8                                                       |
| .1895                      | .3155     | 3/16<br>1/4<br>5/16<br>3/8<br>1/2                          | 7/16      | 1/16       | 202088<br>202089<br>202090<br>202001<br>202091                               | EF030503 (FL-19-1.5)<br>EF030504 (FL-19-2)<br>EF030505 (FL-19-2.5)<br>EF030506 (FL-19-3)<br>EF030508 (FL-19-4) |
| <b>3/16 X 3/8 NOMINAL</b>  |           |                                                            |           |            |                                                                              |                                                                                                                |
| .1895                      | .3765     | 3/8<br>1/2                                                 | 7/16      | 1/16       | 102010<br>102011                                                             | FF-307<br>FF-307-2                                                                                             |
| <b>1/4 X 3/8 NOMINAL</b>   |           |                                                            |           |            |                                                                              |                                                                                                                |
| .250                       | .381      | 3/16<br>1/4<br>5/16<br>3/8<br>7/16<br>1/2<br>9/16<br>11/16 | 1/2       | 1/16       | 102012<br>102013<br>102014<br>102015<br>102016<br>102017<br>102018<br>102019 | FF-310<br>FF-310-3<br>FF-310-4<br>FF-310-1<br>FF-310-5<br>FF-310-2<br>FF-310-7<br>FF-310-10                    |
| .252                       | .377      | 3/16<br>1/4<br>5/16<br>3/8<br>7/16<br>1/2<br>5/8<br>3/4    | 15/32     | 1/16       | 402006<br>402007<br>402008<br>402009<br>402010<br>402011<br>402012<br>402013 | SF-812-3<br>SF-812-4<br>SF-812-5<br>SF-812-6<br>SF-812-7<br>SF-812-8<br>SF-812-10<br>SF-812-12                 |
| .252                       | .377      | 1/4<br>3/8<br>1/2<br>5/8<br>3/4                            | 1/2       | 3/64       | 302006<br>302007<br>302008<br>302009<br>302010                               | FB-46-2<br>FB-46-3<br>FB-46-4<br>FB-46-5<br>FB-46-6                                                            |
| .252                       | .3775     | 3/8                                                        | 15/32     | 3/64       | 102023                                                                       | FF-300                                                                                                         |
| .252                       | .3775     | 1/4<br>3/8<br>1/2                                          | 15/32     | 1/16       | 102020<br>102021<br>102022                                                   | FF-312<br>FF-312-1<br>FF-312-2                                                                                 |
| .252                       | .378      | 3/16<br>1/4<br>3/8                                         | 1/2       | 1/16       | 202092<br>202002<br>202003                                                   | EF040603 (FL-26-1.5)<br>EF040604 (FL-26-2)<br>EF040606 (FL-26-3)                                               |
| .252                       | .378      | 7/16<br>1/2<br>5/8<br>3/4                                  | 1/2       | 1/16       | 202093<br>202004<br>202005<br>202006                                         | EF040607 (FL-26-3.5)<br>EF040608 (FL-26-4)<br>EF040610 (FL-26-5)<br>EF040612 (FL-26-6)                         |

| DEC. I.D.                  | DEC. O.D. | NOM. LGTH.                                   | FLG. O.D. | FLG. THICK | ITEM. NO.                                                          | PART. NO.                                                                                  |
|----------------------------|-----------|----------------------------------------------|-----------|------------|--------------------------------------------------------------------|--------------------------------------------------------------------------------------------|
| .252                       | .378      | 1/4<br>3/8<br>1/2<br>5/8<br>3/4              | 1/2       | 1/16       | 402202<br>402203<br>402204<br>402205<br>402206                     | BSF-812-4<br>BSF-812-6<br>BSF-812-8<br>BSF-812-10<br>BSF-812-12                            |
| .253                       | .377      | 1/2                                          | 1/2       | 1/16       | 102024                                                             | FF-375-1                                                                                   |
| <b>1/4 X 7/16 NOMINAL</b>  |           |                                              |           |            |                                                                    |                                                                                            |
| .251                       | .4395     | 1/2                                          | 1/2       | 1/16       | 102025                                                             | FF-435-1                                                                                   |
| <b>1/4 X 1/2 NOMINAL</b>   |           |                                              |           |            |                                                                    |                                                                                            |
| .252                       | .503      | 5/8<br>3/4                                   | 5/8       | 1/16       | 102026<br>102027                                                   | FF-565-2<br>FF-565-3                                                                       |
| .252                       | .503      | 5/8<br>3/4                                   | 5/8       | 1/16       | 402014<br>402015                                                   | SF-816-10<br>SF-816-12                                                                     |
| <b>5/16 X 3/8 NOMINAL</b>  |           |                                              |           |            |                                                                    |                                                                                            |
| .314                       | .377      | 3/8                                          | 1/2       | 3/64       | 302011                                                             | FB-56-3                                                                                    |
| <b>5/16 X 7/16 NOMINAL</b> |           |                                              |           |            |                                                                    |                                                                                            |
| .3125                      | .440      | 3/8<br>1/2<br>7/8                            | 9/16      | 1/16       | 102028<br>102029<br>102030                                         | FF-411-1<br>FF-411-2<br>FF-411-4                                                           |
| .314                       | .439      | 3/8<br>1/2<br>5/8<br>3/4<br>7/8<br>1         | 5/8       | 3/32       | 302012<br>302086<br>302087<br>302013<br>302088<br>302089           | FB-57-3<br>FB-57-4<br>FB-57-5<br>FB-57-6<br>FB-57-7<br>FB-57-8                             |
| .3145                      | .4405     | 3/8<br>1/2<br>3/4                            | 9/16      | 1/16       | 202007<br>202008<br>202009                                         | EF050706 (FL-32-3)<br>EF050708 (FL-32-4)<br>EF050712 (FL-32-6)                             |
| .315                       | .440      | 3/8<br>1/2<br>5/8<br>3/4<br>7/8<br>1         | 9/16      | 1/16       | 402016<br>402017<br>402018<br>402019<br>402020<br>402021           | SF-1014-6<br>SF-1014-8<br>SF-1014-10<br>SF-1014-12<br>SF-1014-14<br>SF-1014-16             |
| <b>5/16 X 1/2 NOMINAL</b>  |           |                                              |           |            |                                                                    |                                                                                            |
| .3135                      | .502      | 3/8<br>3/8<br>1/2<br>5/8                     | 9/16      | 1/16       | 102031<br>302014<br>302015<br>302016                               | FF-501-2<br>FB-58-3<br>FB-58-4<br>FB-58-5                                                  |
| .3145                      | .503      | 3/8                                          | 11/16     | 1/16       | 202010                                                             | EF050806 (FL-33-3)                                                                         |
| .3145                      | .503      | 3/8                                          | 11/16     | 1/16       | 402022                                                             | SF-1016-6                                                                                  |
| <b>3/8 X 1/2 NOMINAL</b>   |           |                                              |           |            |                                                                    |                                                                                            |
| .3765                      | .502      | 1/4<br>5/16<br>3/8<br>1/2                    | 5/8       | 1/16       | 102032<br>102033<br>102034<br>102035                               | FF-520-15<br>FF-520-9<br>FF-520-10<br>FF-520-5                                             |
| .3765                      | .503      | 1/2<br>5/8                                   | 5/8       | 3/32       | 102036<br>102037                                                   | FF-512-2<br>FF-512-3                                                                       |
| .377                       | .502      | 1/4<br>5/16<br>3/8<br>1/2<br>5/8<br>3/4<br>1 | 5/8       | 1/16       | 402023<br>402024<br>402025<br>402026<br>402027<br>402028<br>402029 | SF-1216-4<br>SF-1216-5<br>SF-1216-6<br>SF-1216-8<br>SF-1216-10<br>SF-1216-12<br>SF-1216-16 |
| .377                       | .502      | 3/8<br>13/32                                 | 11/16     | 3/32       | 302017<br>302018                                                   | FB-68-3<br>FB-68-3-1/4                                                                     |
| .377                       | .502      | 1/2<br>5/8<br>3/4                            | 11/16     | 3/32       | 302019<br>302020<br>302021                                         | FB-68-4<br>FB-68-5<br>FB-68-6                                                              |

\*Other sizes, tolerances, lubricants and materials are available on special orders.



| DEC. I.D.                  | DEC. O.D. | NOM. LGTH. | FLG. O.D. | FLG. THICK | ITEM. NO. | PART. NO.   |            |
|----------------------------|-----------|------------|-----------|------------|-----------|-------------|------------|
|                            |           | 7/8        |           |            | 302090    | FB-68-7     |            |
|                            |           | 1          |           |            | 302022    | FB-68-8     |            |
|                            |           | 1-1/4      |           |            | 302023    | FB-68-10    |            |
| .377                       | .503      | 1/4        | 11/16     | 1/16       | 202094    | EF060804    | (FL-38-2)  |
|                            |           | 3/8        |           |            | 202095    | EF060806    | (FL-38-3)  |
|                            |           | 1/2        |           |            | 202011    | EF060808    | (FL-38-4)  |
|                            |           | 3/4        |           |            | 202012    | EF060812    | (FL-38-6)  |
|                            |           | 1          |           |            | 202013    | EF060816    | (FL-38-8)  |
| .377                       | .503      | 1/2        | 11/16     | 1/16       | 402211    | BSF-1216-8  |            |
|                            |           | 3/4        |           |            | 402212    | BSF-1216-12 |            |
|                            |           | 1          |           |            | 402213    | BSF-1216-16 |            |
| .378                       | .503      | 1/2        | 3/4       | 3/32       | 102038    | FF-519-2    |            |
| <b>3/8 X 9/16 NOMINAL</b>  |           |            |           |            |           |             |            |
| .376                       | .564      | 1/2        | .740      | 1/16       | 102039    | FF-503-6    |            |
|                            |           | 11/16      |           |            | 102040    | FF-503-4    |            |
|                            |           | 13/16      |           |            | 102041    | FF-503      |            |
| .377                       | .5645     | 1/2        | 3/4       | 1/8        | 302091    | FB-69-4     |            |
|                            |           | 3/4        |           |            | 302024    | FB-69-6     |            |
|                            |           | 1-1/4      |           |            | 302025    | FB-69-10    |            |
| .377                       | .5655     | 1/2        | 11/16     | 1/16       | 202014    | EF060908    | (FL-39-4)  |
|                            |           | 3/4        |           |            | 202015    | EF060912    | (FL-39-6)  |
| .377                       | .5655     | 1/2        | 11/16     | 1/16       | 402030    | SF-1218-8   |            |
| <b>3/8 X 5/8 NOMINAL</b>   |           |            |           |            |           |             |            |
| .376                       | .627      | 1/2        | 7/8       | 1/16       | 102042    | FF-607-2    |            |
|                            |           | 3/4        |           |            | 102043    | FF-607-3    |            |
|                            |           | 1-1/4      |           |            | 102044    | FF-607-1    |            |
| .377                       | .627      | 1/2        | 7/8       | 1/16       | 402031    | SF-1220-8   |            |
|                            |           | 3/4        |           |            | 402032    | SF-1220-12  |            |
|                            |           | 1          |           |            | 402033    | SF-1220-16  |            |
|                            |           | 1-1/4      |           |            | 402034    | SF-1220-20  |            |
| .377                       | .627      | 3/8        | 7/8       | 1/8        | 302092    | FB-610-3    |            |
|                            |           | 1/2        |           |            | 302026    | FB-610-4    |            |
|                            |           | 5/8        |           |            | 302093    | FB-610-5    |            |
|                            |           | 3/4        |           |            | 302027    | FB-610-6    |            |
|                            |           | 1          |           |            | 302028    | FB-610-8    |            |
|                            |           | 1-1/4      |           |            | 302029    | FB-610-10   |            |
| .377                       | .628      | 1/2        | 7/8       | 1/16       | 202016    | EF061008    | (FL-40-4)  |
|                            |           | 3/4        |           |            | 202017    | EF061012    | (FL-40-6)  |
|                            |           | 1          |           |            | 202018    | EF061016    | (FL-40-8)  |
|                            |           | 1-1/4      |           |            | 202019    | EF061020    | (FL-40-10) |
| <b>3/8 X 3/4 NOMINAL</b>   |           |            |           |            |           |             |            |
| .377                       | .753      | 1/2        | 1         | 1/8        | 302030    | FB-612-4    |            |
| <b>7/16 X 9/16 NOMINAL</b> |           |            |           |            |           |             |            |
| .439                       | .565      | 1/2        | 11/16     | 1/16       | 102045    | FF-504-3    |            |
|                            |           | 5/8        |           |            | 102046    | FF-504      |            |
|                            |           | 3/4        |           |            | 102047    | FF-504-1    |            |
| .439                       | .565      | 1/2        | 11/16     | 1/16       | 402035    | SF-1418-8   |            |
|                            |           | 5/8        |           |            | 402036    | SF-1418-10  |            |
|                            |           | 3/4        |           |            | 402037    | SF-1418-12  |            |
| .4395                      | .5655     | 1/2        | 11/16     | 1/16       | 202020    | EF070908    | (FL-43-4)  |
|                            |           | 3/4        |           |            | 202021    | EF070912    | (FL-43-6)  |
| <b>7/16 X 5/8 NOMINAL</b>  |           |            |           |            |           |             |            |
| .4385                      | .627      | 3/4        | 7/8       | 1/8        | 102048    | FF-608-3    |            |
|                            |           | 1-1/4      |           |            | 102049    | FF-608      |            |
| .439                       | .628      | 5/8        | 7/8       | 1/8        | 302031    | FB-710-5    |            |
|                            |           | 3/4        |           |            | 302094    | FB-710-6    |            |
|                            |           | 1-1/4      |           |            | 302032    | FB-710-10   |            |
| .439                       | .628      | 5/8        | 7/8       | 1/8        | 402038    | SF-1420-10  |            |
| .439                       | .628      | 3/4        | 7/8       | 1/8        | 402039    | SF-1420-12  |            |
|                            |           | 1          |           |            | 402040    | SF-1420-16  |            |
|                            |           | 1-1/4      |           |            | 402041    | SF-1420-20  |            |
| .4395                      | .628      | 3/4        | 7/8       | 1/8        | 202022    | EF071012    | (FL-44-6)  |
|                            |           | 1-1/4      |           |            | 202023    | EF071020    | (FL-44-10) |

| DEC. I.D.                  | DEC. O.D. | NOM. LGTH. | FLG. O.D. | FLG. THICK | ITEM. NO. | PART. NO.   |             |
|----------------------------|-----------|------------|-----------|------------|-----------|-------------|-------------|
| <b>1/2 X 5/8 NOMINAL</b>   |           |            |           |            |           |             |             |
| .502                       | .627      | 5/16       | 3/4       | 3/32       | 102053    | FF-636-3    |             |
|                            |           | 3/8        |           |            | 102161    | FF-636-2    |             |
| .502                       | .627      | 3/16       | 7/8       | 1/16       | 102054    | FF-620-9    |             |
|                            |           | 1/2        |           |            | 102055    | FF-620-1    |             |
|                            |           | 9/16       |           |            | 102056    | FF-620-5    |             |
|                            |           | 5/8        |           |            | 102057    | FF-620-7    |             |
|                            |           | 11/16      |           |            | 102058    | FF-620      |             |
|                            |           | 3/4        |           |            | 102059    | FF-620-2    |             |
|                            |           | 15/16      |           |            | 102060    | FF-620-6    |             |
|                            |           | 1          |           |            | 102061    | FF-620-3    |             |
|                            |           | 1-1/8      |           |            | 102062    | FF-620-4    |             |
| .502                       | .627      | 1/4        | 7/8       | 1/16       | 402042    | SF-1620-4   |             |
|                            |           | 3/8        |           |            | 402043    | SF-1620-6   |             |
|                            |           | 1/2        |           |            | 402044    | SF-1620-8   |             |
|                            |           | 9/16       |           |            | 402045    | SF-1620-9   |             |
|                            |           | 5/8        |           |            | 402046    | SF-1620-10  |             |
|                            |           | 11/16      |           |            | 402047    | SF-1620-11  |             |
|                            |           | 3/4        |           |            | 402048    | SF-1620-12  |             |
|                            |           | 1          |           |            | 402049    | SF-1620-16  |             |
|                            |           | 1-1/4      |           |            | 402050    | SF-1620-20  |             |
|                            |           | 1-1/2      |           |            | 402138    | SF-1620-24  |             |
| .502                       | .627      | 1/2        | 31/32     | 3/32       | 102050    | FF-600-5    |             |
|                            |           | 1          |           |            | 102051    | FF-600-2    |             |
|                            |           | 1-3/4      |           |            | 102052    | FF-600      |             |
| .502                       | .628      | 1/2        | 7/8       | 1/8        | 302033    | FB-810-4    |             |
|                            |           | 5/8        |           |            | 302034    | FB-810-5    |             |
|                            |           | 3/4        |           |            | 302035    | FB-810-6    |             |
|                            |           | 7/8        |           |            | 302095    | FB-810-7    |             |
|                            |           | 1          |           |            | 302036    | FB-810-8    |             |
|                            |           | 1-1/4      |           |            | 302037    | FB-810-10   |             |
|                            |           | 1-1/2      |           |            | 302038    | FB-810-12   |             |
|                            |           | 1-3/4      |           |            | 302039    | FB-810-14   |             |
| .502                       | .628      | 5/16       | 7/8       | 1/8        | 202096    | EF081005    | (FL-50-2.5) |
|                            |           | 3/8        |           |            | 202024    | EF081006    | (FL-50-3)   |
|                            |           | 1/2        |           |            | 202025    | EF081008    | (FL-50-4)   |
|                            |           | 5/8        |           |            | 202097    | EF081010    | (FL-50-5)   |
|                            |           | 3/4        |           |            | 202026    | EF081012    | (FL-50-6)   |
|                            |           | 1          |           |            | 202027    | EF081016    | (FL-50-8)   |
|                            |           | 1-1/4      |           |            | 202028    | EF081020    | (FL-50-10)  |
|                            |           | 1-1/2      |           |            | 202029    | EF081024    | (FL-50-12)  |
| .502                       | .628      | 3/8        | 7/8       | 1/8        | 402224    | BSF-1620-6  |             |
|                            |           | 1/2        |           |            | 402225    | BSF-1620-8  |             |
|                            |           | 3/4        |           |            | 402226    | BSF-1620-12 |             |
|                            |           | 1          |           |            | 402227    | BSF-1620-16 |             |
|                            |           | 1-1/4      |           |            | 402228    | BSF-1620-20 |             |
|                            |           | 1-1/2      |           |            | 402229    | BSF-1620-24 |             |
| <b>1/2 X 11/16 NOMINAL</b> |           |            |           |            |           |             |             |
| .502                       | .690      | 1/2        | 15/16     | 1/8        | 302040    | FB-811-4    |             |
|                            |           | 5/8        |           |            | 302096    | FB-811-5    |             |
|                            |           | 3/4        |           |            | 302041    | FB-811-6    |             |
| .502                       | .6905     | 5/16       | 7/8       | 1/8        | 202098    | EF081105    | (FL-51-2.5) |
|                            |           | 1/2        |           |            | 202030    | EF081108    | (FL-51-4)   |
|                            |           | 3/4        |           |            | 202031    | EF081112    | (FL-51-6)   |
| .502                       | .6905     | 5/16       | 7/8       | 1/8        | 402051    | SF-1622-5   |             |
|                            |           | 1/2        |           |            | 402052    | SF-1622-8   |             |
|                            |           | 3/4        |           |            | 402053    | SF-1622-12  |             |
|                            |           | 7/8        |           |            | 402054    | SF-1622-14  |             |
| .502                       | .691      | 5/16       | 13/16     | 1/16       | 102066    | FF-609-1    |             |
|                            |           | 1/2        |           |            | 102067    | FF-609-3    |             |
|                            |           | 3/4        |           |            | 102068    | FF-609-4    |             |
|                            |           | 13/16      |           |            | 102069    | FF-609      |             |

\*Other sizes, tolerances, lubricants and materials are available on special orders.



| DEC. I.D.                  | DEC. O.D. | NOM. LGTH. | FLG. O.D. | FLG. THICK | ITEM. NO. | PART. NO.           |
|----------------------------|-----------|------------|-----------|------------|-----------|---------------------|
| <b>1/2 X 11/16 NOMINAL</b> |           |            |           |            |           |                     |
| .502                       | .691      | 1/2        | 31/32     | 3/32       | 102063    | FF-604-2            |
|                            |           | 3/4        |           |            | 102064    | FF-604-1            |
|                            |           | 13/16      |           |            | 102065    | FF-604              |
| <b>1/2 X 3/4 NOMINAL</b>   |           |            |           |            |           |                     |
| .502                       | .753      | 1/2        | 15/16     | 1/8        | 102070    | FF-707-5            |
|                            |           | 3/4        |           |            | 102071    | FF-707-2            |
|                            |           | 1          |           |            | 102072    | FF-707-3            |
| .502                       | .753      | 3/8        | 15/16     | 1/8        | 402055    | SF-1624-6           |
|                            |           | 1/2        |           |            | 402056    | SF-1624-8           |
|                            |           | 5/8        |           |            | 402057    | SF-1624-10          |
|                            |           | 3/4        |           |            | 402058    | SF-1624-12          |
|                            |           | 1          |           |            | 402059    | SF-1624-16          |
|                            |           | 1-1/4      |           |            | 402060    | SF-1624-20          |
|                            |           | 1-1/2      |           |            | 402061    | SF-1624-24          |
| .502                       | .753      | 1/2        | 1         | 1/8        | 302042    | FB-812-4            |
|                            |           | 5/8        |           |            | 302097    | FB-812-5            |
|                            |           | 3/4        |           |            | 302043    | FB-812-6            |
|                            |           | 7/8        |           |            | 302044    | FB-812-7            |
|                            |           | 1          |           |            | 302045    | FB-812-8            |
|                            |           | 1-1/4      |           |            | 302046    | FB-812-10           |
|                            |           | 1-1/2      |           |            | 302047    | FB-812-12           |
| .502                       | .753      | 1/2        | 1         | 1/8        | 202032    | EF081208 (FL-52-4)  |
|                            |           | 5/8        |           |            | 202087    | EF081210 (FL-52-5)  |
|                            |           | 3/4        |           |            | 202033    | EF081212 (FL-52-6)  |
|                            |           | 1          |           |            | 202034    | EF081216 (FL-52-8)  |
|                            |           | 1-1/4      |           |            | 202035    | EF081220 (FL-52-10) |
| .502                       | .753      | 1/2        | 1         | 1/8        | 402232    | BSF-1624-8          |
|                            |           | 5/8        |           |            | 402287    | BSF-1624-10         |
|                            |           | 3/4        |           |            | 402233    | BSF-1624-12         |
|                            |           | 1          |           |            | 402234    | BSF-1624-16         |
|                            |           | 1-1/4      |           |            | 402235    | BSF-1624-20         |
| .503                       | .753      | 3/4        | 15/16     | 1/8        | 102073    | FF-710              |
| .505                       | .753      | 3/8        | 1         | 1/8        | 102074    | FF-723-5            |
|                            |           | 1/2        |           |            | 102075    | FF-723-1            |
|                            |           | 5/8        |           |            | 102076    | FF-723              |
| <b>9/16 X 3/4 NOMINAL</b>  |           |            |           |            |           |                     |
| .565                       | .753      | 1/2        | 1         | 1/8        | 302098    | FB-912-4            |
|                            |           | 3/4        |           |            | 302099    | FB-912-6            |
|                            |           | 1          |           |            | 302048    | FB-912-8            |
| <b>5/8 X 3/4 NOMINAL</b>   |           |            |           |            |           |                     |
| .626                       | .753      | 1/2        | 1         | 1/8        | 302049    | FB-1012-4           |
|                            |           | 5/8        |           |            | 302050    | FB-1012-5           |
|                            |           | 3/4        |           |            | 302051    | FB-1012-6           |
|                            |           | 1          |           |            | 302052    | FB-1012-8           |
|                            |           | 1-1/4      |           |            | 302053    | FB-1012-10          |
| .6265                      | .7525     | 5/8        | 1         | 3/32       | 102077    | FF-703-3            |
|                            |           | 3/4        |           |            | 102078    | FF-703-7            |
|                            |           | 1          |           |            | 102079    | FF-703-1            |
|                            |           | 1-1/8      |           |            | 102080    | FF-703              |
|                            |           | 1-1/4      |           |            | 102081    | FF-703-6            |
| .627                       | .753      | 1/2        | 1         | 3/32       | 402062    | SF-2024-8           |
|                            |           | 5/8        |           |            | 402063    | SF-2024-10          |
|                            |           | 3/4        |           |            | 402064    | SF-2024-12          |
|                            |           | 1          |           |            | 402065    | SF-2024-16          |
|                            |           | 1-1/8      |           |            | 402066    | SF-2024-18          |
|                            |           | 1-1/4      |           |            | 402067    | SF-2024-20          |
|                            |           | 1-1/2      |           |            | 402068    | SF-2024-24          |
| .627                       | .753      | 5/8        | 1         | 1/8        | 202036    | EF101210 (FL-62-5)  |
|                            |           | 3/4        |           |            | 202037    | EF101212 (FL-62-6)  |

| DEC. I.D.                  | DEC. O.D. | NOM. LGTH. | FLG. O.D. | FLG. THICK | ITEM. NO. | PART. NO.           |
|----------------------------|-----------|------------|-----------|------------|-----------|---------------------|
| <b>5/8 x 3/4 NOMINAL</b>   |           |            |           |            |           |                     |
|                            |           | 1          |           |            | 202038    | EF101216 (FL-62-8)  |
|                            |           | 1-1/8      |           |            | 202039    | EF101218 (FL-62-9)  |
| .627                       | .753      | 5/8        | 1         | 1/8        | 402236    | BSF-2024-10         |
|                            |           | 3/4        |           |            | 402237    | BSF-2024-12         |
|                            |           | 1          |           |            | 402238    | BSF-2024-16         |
|                            |           | 1-1/8      |           |            | 402239    | BSF-2024-18         |
| .6275                      | .7525     | 1/2        | 7/8       | 1/16       | 102082    | FF-718-1            |
|                            |           | 1          |           |            | 102083    | FF-718-3            |
|                            |           | 1-1/8      |           |            | 102084    | FF-718-6            |
| <b>5/8 X 13/16 NOMINAL</b> |           |            |           |            |           |                     |
| .625                       | .815      | 1          | 1         | 1/8        | 102085    | FF-823-3            |
|                            |           | 1-1/4      |           |            | 102086    | FF-823              |
| .626                       | .815      | 1/2        | 1         | 1/8        | 102087    | FF-842-1            |
|                            |           | 3/4        |           |            | 102088    | FF-842-2            |
|                            |           | 1          |           |            | 102089    | FF-842-3            |
| .627                       | .815      | 5/8        | 1-1/16    | 5/32       | 302100    | FB-1013-5           |
|                            |           | 3/4        |           |            | 302054    | FB-1013-6           |
|                            |           | 1          |           |            | 302055    | FB-1013-8           |
|                            |           | 1-1/4      |           |            | 302056    | FB-1013-10          |
|                            |           | 1-7/16     |           |            | 302057    | FB-1013-11.5        |
|                            |           | 1-1/2      |           |            | 302058    | FB-1013-12          |
|                            |           | 2          |           |            | 302059    | FB-1013-16          |
| .627                       | .8165     | 3/4        | 1         | 1/8        | 202040    | EF101312 (FL-63-6)  |
|                            |           | 1          |           |            | 202041    | EF101316 (FL-63-8)  |
|                            |           | 1-1/4      |           |            | 202042    | EF101320 (FL-63-10) |
|                            |           | 1-1/2      |           |            | 202043    | EF101324 (FL-63-12) |
| .628                       | .815      | 3/4        | 1         | 1/8        | 402069    | SF-2026-12          |
|                            |           | 1          |           |            | 402070    | SF-2026-16          |
|                            |           | 1-1/4      |           |            | 402071    | SF-2026-20          |
|                            |           | 1-1/2      |           |            | 402072    | SF-2026-24          |
| .628                       | .816      | 3/4        | 1-1/4     | 1/8        | 102090    | FF-806-1            |
|                            |           | 1-7/16     |           |            | 102091    | FF-806              |
| .6295                      | .8155     | 1/2        | 1         | 1/8        | 102092    | FF-805-2            |
|                            |           | 3/4        |           |            | 102093    | FF-805              |
|                            |           | 1          |           |            | 102094    | FF-805-3            |
| <b>5/8 X 7/8 NOMINAL</b>   |           |            |           |            |           |                     |
| .627                       | .877      | 5/8        | 1         | 1/8        | 102095    | FF-843-4            |
|                            |           | 3/4        |           |            | 102096    | FF-843              |
|                            |           | 1          |           |            | 102097    | FF-843-2            |
|                            |           | 1-1/4      |           |            | 102098    | FF-843-3            |
| .627                       | .878      | 5/8        | 1-1/8     | 5/32       | 302101    | FB-1014-5           |
|                            |           | 3/4        |           |            | 302060    | FB-1014-6           |
|                            |           | 1          |           |            | 302061    | FB-1014-8           |
|                            |           | 1-3/4      |           |            | 302062    | FB-1014-14          |
| .627                       | .879      | 1/2        | 1-1/8     | 1/8        | 202044    | EF101408 (FL-64-4)  |
|                            |           | 5/8        |           |            | 202100    | EF101410 (FL-64-5)  |
|                            |           | 3/4        |           |            | 202045    | EF101412 (FL-64-6)  |
|                            |           | 1          |           |            | 202046    | EF101416 (FL-64-8)  |
|                            |           | 1-1/4      |           |            | 202047    | EF101420 (FL-64-10) |
| .627                       | .879      | 1/2        | 1-1/8     | 1/8        | 402244    | BSF-2028-8          |
|                            |           | 3/4        |           |            | 402245    | BSF-2028-12         |
|                            |           | 1          |           |            | 402246    | BSF-2028-16         |
|                            |           | 1-1/4      |           |            | 402247    | BSF-2028-20         |
| .628                       | .878      | 5/8        | 1-1/8     | 1/8        | 402073    | SF-2028-10          |
|                            |           | 3/4        |           |            | 402074    | SF-2028-12          |
|                            |           | 1          |           |            | 402075    | SF-2028-16          |
|                            |           | 1-1/4      |           |            | 402076    | SF-2028-20          |
|                            |           | 1-1/2      |           |            | 402077    | SF-2028-24          |

\*Other sizes, tolerances, lubricants and materials are available on special orders.



| DEC. I.D.                  | DEC. O.D. | NOM. LGTH. | FLG. O.D. | FLG. THICK | ITEM. NO. | PART. NO.  |             |
|----------------------------|-----------|------------|-----------|------------|-----------|------------|-------------|
| <b>5/8 X 1 NOMINAL</b>     |           |            |           |            |           |            |             |
| .627                       | 1.003     | 3/4        | 1-1/4     | 5/32       | 302102    | FB-1016-6  |             |
|                            |           | 1          |           |            | 302063    | FB-1016-8  |             |
| .627                       | 1.003     | 1          | 1-1/4     | 3/16       | 402078    | SF-2032-16 |             |
| .627                       | 1.004     | 1          | 1-1/4     | 3/16       | 202048    | EF101616   | (FL-66-8)   |
| <b>3/4 X 7/8 NOMINAL</b>   |           |            |           |            |           |            |             |
| .751                       | .877      | 1/2        | 1         | 1/16       | 102099    | FF-838-1   |             |
|                            |           | 1          |           |            | 102100    | FF-838-3   |             |
| .752                       | .878      | 3/4        | 1-1/8     | 5/32       | 302064    | FB-1214-6  |             |
|                            |           | 1          |           |            | 302065    | FB-1214-8  |             |
|                            |           | 1-1/4      |           |            | 302103    | FB-1214-10 |             |
| .752                       | .879      | 1/2        | 1-1/8     | 1/8        | 202049    | EF121408   | (FL-75-4)   |
|                            |           | 3/4        |           |            | 202050    | EF121412   | (FL-75-6)   |
| <b>3/4 X 7/8 NOMINAL</b>   |           |            |           |            |           |            |             |
| .753                       | .878      | 1/2        | 1-1/8     | 1/8        | 402079    | SF-2428-8  |             |
|                            |           | 3/4        |           |            | 402080    | SF-2428-12 |             |
|                            |           | 1          |           |            | 402081    | SF-2428-16 |             |
|                            |           | 1-1/2      |           |            | 402082    | SF-2428-24 |             |
| <b>3/4 X 15/16 NOMINAL</b> |           |            |           |            |           |            |             |
| .7505                      | .941      | 3/4        | 1-1/8     | 3/32       | 102101    | FF-911-3   |             |
|                            |           |            |           |            | 102102    | FF-911-4   |             |
| .752                       | .940      | 1          | 1-3/16    | 5/32       | 302066    | FB-1215-8  |             |
|                            |           | 1-1/4      |           |            | 302104    | FB-1215-10 |             |
|                            |           | 1-1/2      |           |            | 302067    | FB-1215-12 |             |
| .752                       | .9415     | 9/16       | 1-1/4     | 1/8        | 202101    | EF121509   | (FL-76-4.5) |
|                            |           | 3/4        |           |            | 202051    | EF121512   | (FL-76-6)   |
|                            |           | 1          |           |            | 202052    | EF121516   | (FL-76-8)   |
|                            |           | 1-1/8      |           |            | 202053    | EF121518   | (FL-76-9)   |
|                            |           | 1-1/4      |           |            | 202054    | EF121520   | (FL-76-10)  |
|                            |           | 1-1/2      |           |            | 202055    | EF121524   | (FL-76-12)  |
| .753                       | .938      | 9/16       | 1-5/16    | 1/8        | 102103    | FF-901-4   |             |
|                            |           | 3/4        |           |            | 102104    | FF-901-6   |             |
|                            |           | 1-1/4      |           |            | 102105    | FF-901-8   |             |
|                            |           | 1-9/16     |           |            | 102106    | FF-901     |             |
| .753                       | .940      | 3/4        | 1-1/4     | 1/8        | 402083    | SF-2430-12 |             |
|                            |           | 1          |           |            | 402084    | SF-2430-16 |             |
|                            |           | 1-1/8      |           |            | 402085    | SF-2430-18 |             |
|                            |           | 1-1/4      |           |            | 402086    | SF-2430-20 |             |
|                            |           | 1-1/2      |           |            | 402087    | SF-2430-24 |             |
| .753                       | .9405     | 1-1/8      | 1.175     | 1/8        | 102107    | FF-905     |             |
| <b>3/4 X 1 NOMINAL</b>     |           |            |           |            |           |            |             |
| .7505                      | 1.002     | 1/2        | 1-7/16    | 1/8        | 102108    | FF-1011-2  |             |
|                            |           | 5/8        |           |            | 102109    | FF-1011    |             |
|                            |           | 1          |           |            | 102110    | FF-1011-4  |             |
|                            |           | 1-1/8      |           |            | 102111    | FF-1011-1  |             |
| .751                       | 1.002     | 3/4        | 1-1/2     | 1/8        | 102112    | FF-1013-2  |             |
|                            |           | 1          |           |            | 102113    | FF-1013    |             |
|                            |           | 1-1/4      |           |            | 102114    | FF-1013-3  |             |
|                            |           | 1-1/2      |           |            | 102115    | FF-1013-4  |             |
| .752                       | 1.002     | 3/4        | 1-5/16    | 1/8        | 102116    | FF-1014-2  |             |
|                            |           | 1          |           |            | 102117    | FF-1014    |             |
| .752                       | 1.003     | 5/8        | 1-1/4     | 5/32       | 302105    | FB-1216-5  |             |
|                            |           | 3/4        |           |            | 302068    | FB-1216-6  |             |
|                            |           | 1-1/2      |           |            | 302069    | FB-1216-8  |             |
|                            |           | 1-2/4      |           |            | 302070    | FB-1216-10 |             |
|                            |           |            |           |            | 302071    | FB-1216-12 |             |
|                            |           |            |           |            | 302072    | FB-1216-16 |             |

| DEC. I.D.                   | DEC. O.D. | NOM. LGTH. | FLG. O.D. | FLG. THICK | ITEM. NO. | PART. NO.   |            |
|-----------------------------|-----------|------------|-----------|------------|-----------|-------------|------------|
| <b>3/4 X 1 NOMINAL</b>      |           |            |           |            |           |             |            |
| .752                        | 1.004     | 5/8        | 1-1/4     | 3/16       | 202056    | EF121610    | (FL-77-5)  |
|                             |           | 3/4        |           |            | 202057    | EF121612    | (FL-77-6)  |
|                             |           | 1          |           |            | 202058    | EF121616    | (FL-77-8)  |
|                             |           | 1-1/8      |           |            | 202059    | EF121618    | (FL-77-9)  |
|                             |           | 1-1/4      |           |            | 202060    | EF121620    | (FL-77-10) |
|                             |           | 1-1/2      |           |            | 202061    | EF121624    | (FL-77-12) |
| .752                        | 1.004     | 5/8        | 1-1/4     | 3/16       | 402256    | BSF-2432-10 |            |
|                             |           | 3/4        |           |            | 402257    | BSF-2432-12 |            |
|                             |           | 1          |           |            | 402258    | BSF-2432-16 |            |
|                             |           | 1-1/8      |           |            | 402259    | BSF-2432-18 |            |
|                             |           | 1-1/4      |           |            | 402260    | BSF-2432-20 |            |
|                             |           | 1-1/2      |           |            | 402261    | BSF-2432-24 |            |
| .753                        | 1.003     | 1/2        | 1-1/8     | 1/8        | 102118    | FF-1015-1   |            |
|                             |           | 3/4        |           |            | 102119    | FF-1015-2   |            |
|                             |           | 1          |           |            | 102120    | FF-1015     |            |
| .753                        | 1.003     | 1/2        | 1-1/8     | 1/8        | 402088    | SF-2432-8   |            |
|                             |           | 5/8        |           |            | 402089    | SF-2432-10  |            |
|                             |           | 3/4        |           |            | 402090    | SF-2432-12  |            |
|                             |           | 1          |           |            | 402091    | SF-2432-16  |            |
|                             |           | 1-1/8      |           |            | 402092    | SF-2432-18  |            |
|                             |           | 1-1/4      |           |            | 402093    | SF-2432-20  |            |
|                             |           | 1-1/2      |           |            | 402094    | SF-2432-24  |            |
| <b>3/4 X 1-1/16 NOMINAL</b> |           |            |           |            |           |             |            |
| .752                        | 1.0655    | 1-3/16     | 1-3/16    | 1/8        | 102121    | FF-1010     |            |
| <b>7/8 X 1 NOMINAL</b>      |           |            |           |            |           |             |            |
| .8765                       | 1.003     | 5/8        | 1-1/4     | 1/8        | 102122    | FF-1001-2   |            |
|                             |           | 3/4        |           |            | 102123    | FF-1001-1   |            |
|                             |           | 1          |           |            | 102124    | FF-1001     |            |
| .877                        | 1.003     | 1/2        | 1-1/4     | 1/8        | 402095    | SF-2832-8   |            |
|                             |           | 3/4        |           |            | 402096    | SF-2832-12  |            |
|                             |           | 1          |           |            | 402097    | SF-2832-16  |            |
|                             |           | 1-1/4      |           |            | 402098    | SF-2832-20  |            |
|                             |           | 1-1/2      |           |            | 402099    | SF-2832-24  |            |
| .877                        | 1.003     | 3/4        | 1-1/4     | 5/32       | 302073    | FB-1416-6   |            |
|                             |           | 1          |           |            | 302106    | FB-1416-8   |            |
|                             |           | 1-1/4      |           |            | 302074    | FB-1416-10  |            |
| .877                        | 1.004     | 1/2        | 1-1/4     | 3/16       | 202062    | EF141608    | (FL-87-4)  |
|                             |           | 3/4        |           |            | 202063    | EF141612    | (FL-87-6)  |
|                             |           | 1          |           |            | 202064    | EF141616    | (FL-87-8)  |
| .877                        | 1.004     | 1/2        | 1-1/4     | 3/16       | 402262    | BSF-2832-8  |            |
|                             |           | 3/4        |           |            | 402263    | BSF-2832-12 |            |
|                             |           | 1          |           |            | 402264    | BSF-2832-16 |            |
| <b>7/8 X 1-1/8 NOMINAL</b>  |           |            |           |            |           |             |            |
| .877                        | 1.128     | 1          | 1-3/8     | 5/32       | 302075    | FB-1418-8   |            |
|                             |           | 1-1/4      |           |            | 302107    | FB-1418-10  |            |
|                             |           | 1-1/2      |           |            | 302076    | FB-1418-12  |            |
| .877                        | 1.128     | 5/8        | 1-1/2     | 1/8        | 102125    | FF-1102-6   |            |
|                             |           | 1          |           |            | 102126    | FF-1102-2   |            |
|                             |           | 1-1/4      |           |            | 102127    | FF-1102-3   |            |
|                             |           | 1-3/4      |           |            | 102128    | FF-1102     |            |
| .877                        | 1.129     | 3/4        | 1-1/2     | 1/8        | 202065    | EF141812    | (FL-89-6)  |
|                             |           | 1          |           |            | 202066    | EF141816    | (FL-89-8)  |
|                             |           | 1-1/4      |           |            | 202067    | EF141820    | (FL-89-10) |
|                             |           | 1-1/2      |           |            | 202068    | EF141824    | (FL-89-12) |
|                             |           | 1-3/4      |           |            | 202069    | EF141828    | (FL-89-14) |
| .878                        | 1.128     | 5/8        | 1-1/2     | 1/8        | 402100    | SF-2836-10  |            |
|                             |           | 3/4        |           |            | 402101    | SF-2836-12  |            |

\*Other sizes, tolerances, lubricants and materials are available on special orders.





| DEC. I.D.                    | DEC. O.D. | NOM. LGTH. | FLG. O.D. | FLG. THICK | ITEM. NO. | PART. NO.            |
|------------------------------|-----------|------------|-----------|------------|-----------|----------------------|
| <b>7/8 X 1-1/8 NOMINAL</b>   |           |            |           |            |           |                      |
|                              |           | 1          |           |            | 402102    | SF-2836-16           |
|                              |           | 1-1/4      |           |            | 402103    | SF-2836-20           |
|                              |           | 1-1/2      |           |            | 402104    | SF-2836-24           |
|                              |           | 1-3/4      |           |            | 402105    | SF-2836-28           |
| <b>1 X 1-1/4 NOMINAL</b>     |           |            |           |            |           |                      |
| 1.001                        | 1.252     | 3/4        | 1-1/2     | 1/8        | 102129    | FF-1213-1            |
|                              |           | 1-1/2      |           |            | 102130    | FF-1213-4            |
| 1.001                        | 1.253     | 3/4        | 1-7/8     | 1/8        | 102131    | FF-1202-4            |
|                              |           | 1          |           |            | 102132    | FF-1202-3            |
|                              |           | 1-1/4      |           |            | 102133    | FF-1202              |
| 1.002                        | 1.252     | 3/4        | 1-5/8     | 1/8        | 102134    | FF-1207-5            |
|                              |           | 1-1/4      |           |            | 102135    | FF-1207-7            |
|                              |           | 1-1/2      |           |            | 102136    | FF-1207-3            |
|                              |           | 1-3/4      |           |            | 102137    | FF-1207              |
| 1.002                        | 1.253     | 3/4        | 1-1/2     | 3/16       | 302077    | FB-1620-6            |
|                              |           | 1          |           |            | 302078    | FB-1620-8            |
|                              |           | 1-1/4      |           |            | 302079    | FB-1620-10           |
|                              |           | 1-1/2      |           |            | 302080    | FB-1620-12           |
|                              |           | 2          |           |            | 302081    | FB-1620-16           |
| 1.003                        | 1.253     | 3/4        | 1-5/8     | 1/8        | 402106    | SF-3240-12           |
|                              |           | 1          |           |            | 402107    | SF-3240-16           |
|                              |           | 1-1/4      |           |            | 402108    | SF-3240-20           |
|                              |           | 1-1/2      |           |            | 402109    | SF-3240-24           |
|                              |           | 1-3/4      |           |            | 402110    | SF-3240-28           |
|                              |           | 2          |           |            | 402111    | SF-3240-32           |
| 1.003                        | 1.254     | 3/4        | 1-1/2     | 1/8        | 202070    | EF162012 (FL-102-6)  |
|                              |           | 1          |           |            | 202071    | EF162016 (FL-102-8)  |
| 1.003                        | 1.254     | 1-1/4      | 1-1/2     | 1/8        | 202072    | EF162020 (FL-102-10) |
|                              |           | 1-1/2      |           |            | 202073    | EF162024 (FL-102-12) |
| 1.003                        | 1.254     | 3/4        | 1-1/2     | 1/8        | 402270    | BSF-3240-12          |
|                              |           | 1          |           |            | 402271    | BSF-3240-16          |
|                              |           | 1-1/4      |           |            | 402272    | BSF-3240-20          |
|                              |           | 1-1/2      |           |            | 402273    | BSF-3240-24          |
| <b>1 X 1-5/16 NOMINAL</b>    |           |            |           |            |           |                      |
| 1.001                        | 1.316     | 1-1/4      | 1-3/4     | 7/32       | 102138    | FF-1302              |
|                              |           | 1-1/2      |           |            | 102139    | FF-1302-3            |
| 1.0015                       | 1.3155    | 1-1/2      | 1-7/8     | 1/8        | 102140    | FF-1301              |
| <b>1 X 1-3/8 NOMINAL</b>     |           |            |           |            |           |                      |
| 1.000                        | 1.3785    | 1-3/4      | 1-3/4     | 3/16       | 102141    | FF-1304              |
|                              |           | 2          |           |            | 102142    | FF-1304-1            |
| 1.002                        | 1.378     | 1          | 1-5/8     | 3/16       | 302082    | FB-1622-8            |
|                              |           | 1-1/2      |           |            | 302108    | FB-1622-12           |
|                              |           | 1-3/4      |           |            | 302083    | FB-1622-14           |
| 1.003                        | 1.378     | 3/4        | 1-5/8     | 3/16       | 402112    | SF-3244-12           |
|                              |           | 1          |           |            | 402113    | SF-3244-16           |
|                              |           | 1-1/2      |           |            | 402114    | SF-3244-24           |
|                              |           | 1-3/4      |           |            | 402115    | SF-3244-28           |
|                              |           | 2          |           |            | 402116    | SF-3244-32           |
| 1.003                        | 1.379     | 3/4        | 1-5/8     | 3/16       | 202074    | EF162212 (FL-104-6)  |
|                              |           | 1          |           |            | 202075    | EF162216 (FL-104-8)  |
|                              |           | 1-1/2      |           |            | 202076    | EF162224 (FL-104-12) |
|                              |           | 1-3/4      |           |            | 202077    | EF162228 (FL-104-14) |
|                              |           | 2          |           |            | 202078    | EF162232 (FL-104-16) |
| <b>1-1/8 X 1-3/8 NOMINAL</b> |           |            |           |            |           |                      |
| 1.127                        | 1.377     | 3/4        | 1-3/4     | 1/8        | 102143    | FF-1314-1            |
|                              |           | 1          |           |            | 102144    | FF-1314-2            |
|                              |           | 1-1/4      |           |            | 102145    | FF-1314-3            |
| 1.127                        | 1.377     | 3/4        | 1-3/4     | 1/8        | 402117    | SF-3644-12           |
|                              |           | 1          |           |            | 402118    | SF-3644-16           |
|                              |           | 1-1/4      |           |            | 402119    | SF-3644-20           |

| DEC. I.D.                    | DEC. O.D. | NOM. LGTH. | FLG. O.D. | FLG. THICK | ITEM. NO. | PART. NO.            |
|------------------------------|-----------|------------|-----------|------------|-----------|----------------------|
| <b>1-1/4 X 1-1/2 NOMINAL</b> |           |            |           |            |           |                      |
| 1.2515                       | 1.503     | 1/2        | 1-11/16   | 1/8        | 102146    | FF-1505-5            |
|                              |           | 1-1/4      |           |            | 102147    | FF-1505              |
| 1.252                        | 1.503     | 1/2        | 1-11/16   | 1/8        | 402120    | SF-4048-8            |
|                              |           | 3/4        |           |            | 402121    | SF-4048-12           |
|                              |           | 1          |           |            | 402122    | SF-4048-16           |
|                              |           | 1-1/4      |           |            | 402123    | SF-4048-20           |
|                              |           | 1-1/2      |           |            | 402124    | SF-4048-24           |
|                              |           | 1-3/4      |           |            | 402125    | SF-4048-28           |
| 1.252                        | 1.503     | 1          | 1-3/4     | 3/16       | 302109    | FB-2024-8            |
|                              |           | 1-1/4      |           |            | 302084    | FB-2024-10           |
|                              |           | 1-1/2      |           |            | 302110    | FB-2024-12           |
| 1.252                        | 1.503     | 1-1/2      | 2         | 3/32       | 102148    | FF-1506-4            |
|                              |           | 1-3/4      |           |            | 102149    | FF-1506-5            |
| 1.2535                       | 1.504     | 1          | 1-3/4     | 3/16       | 202079    | EF202416 (FL-125-8)  |
|                              |           | 1-1/4      |           |            | 202080    | EF202420 (FL-125-10) |
|                              |           | 1-1/2      |           |            | 202081    | EF202424 (FL-125-12) |
|                              |           | 1-3/4      |           |            | 202082    | EF202428 (FL-125-14) |
| 1.2535                       | 1.504     | 1-1/4      | 1-3/4     | 3/16       | 402280    | BSF-4048-20          |
|                              |           | 1-1/2      |           |            | 402281    | BSF-4048-24          |
|                              |           | 1-3/4      |           |            | 402282    | BSF-4048-28          |
| <b>1-3/8 X 1-5/8 NOMINAL</b> |           |            |           |            |           |                      |
| 1.377                        | 1.628     | 3/4        | 2         | 1/8        | 102150    | FF-1618              |
|                              |           | 1          |           |            | 102151    | FF-1618-1            |
| 1.377                        | 1.628     | 3/4        | 2         | 1/8        | 402126    | SF-4452-12           |
|                              |           | 1          |           |            | 402127    | SF-4452-16           |
| <b>1-1/2 X 1-3/4 NOMINAL</b> |           |            |           |            |           |                      |
| 1.503                        | 1.752     | 1-1/2      | 2         | 3/32       | 102152    | FF-1704-4            |
| 1.503                        | 1.752     | 1-1/2      | 2         | 3/32       | 402128    | SF-4856-24           |
| 1.503                        | 1.754     | 1-1/2      | 2-1/16    | 3/16       | 302085    | FB-2428-12           |
| 1.504                        | 1.755     | 1-1/2      | 2         | 3/16       | 202083    | EF242824 (FL-150-12) |
| 1.504                        | 1.755     | 1-1/2      | 2         | 3/16       | 402283    | BSF-4856-24          |
| <b>1-5/8 X 2 NOMINAL</b>     |           |            |           |            |           |                      |
| 1.6265                       | 2.004     | 2          | 2-1/4     | 3/16       | 102153    | FF-2000              |
| 1.6265                       | 2.004     | 2          | 2-1/4     | 3/16       | 402129    | SF-5264-32           |
| 1.629                        | 2.005     | 2          | 2-1/4     | 3/16       | 202084    | EF263232 (FL-163-16) |
| <b>1-3/4 X 2-1/4 NOMINAL</b> |           |            |           |            |           |                      |
| 1.753                        | 2.254     | 2-1/2      | 3         | 1/4        | 102154    | FF-2204-3            |
| 1.753                        | 2.254     | 2-1/2      | 3         | 1/4        | 402130    | SF-5672-40           |
| 1.754                        | 2.255     | 2-1/2      | 3         | 1/4        | 202085    | EF283640 (FL-177-20) |
| <b>2 X 2-1/4 NOMINAL</b>     |           |            |           |            |           |                      |
| 2.003                        | 2.254     | 3/4        | 2-1/2     | 1/8        | 102155    | FF-2203-2            |
|                              |           | 1          |           |            | 102156    | FF-2203-3            |
|                              |           | 1-1/4      |           |            | 102157    | FF-2203-4            |
| 2.003                        | 2.254     | 3/4        | 2-1/2     | 1/8        | 402131    | SF-6472-12           |
|                              |           | 1          |           |            | 402132    | SF-6472-16           |
|                              |           | 1-1/4      |           |            | 402133    | SF-6472-20           |
|                              |           | 2          | 2-1/2     | 1/8        | 402134    | SF-6472-32           |
| 2.004                        | 2.255     | 2          | 2-1/2     | 1/8        | 202086    | EF323632 (FL-200-16) |
| <b>2 X 2-1/2 NOMINAL</b>     |           |            |           |            |           |                      |
| 2.002                        | 2.501     | 2-3/8      | 3         | 3/8        | 102158    | FF-2501              |
| 2.002                        | 2.501     | 2-3/8      | 3         | 3/8        | 402135    | SF-6480-38           |
| <b>2-3/4 X 3-1/4 NOMINAL</b> |           |            |           |            |           |                      |
| 2.752                        | 3.250     | 1-1/2      | 4-1/2     | 3/16       | 102159    | FF-3200-4            |
| <b>3 X 3-1/2 NOMINAL</b>     |           |            |           |            |           |                      |
| 3.002                        | 3.502     | 2-3/8      | 4         | 3/8        | 102160    | FF-3500              |
| 3.002                        | 3.502     | 2-3/8      | 4         | 3/8        | 402137    | SF-96112-38          |

\*Other sizes, tolerances, lubricants and materials are available on special orders.

| DECIMAL I.D.              | DECIMAL O.D. | THICKNESS | ITEM NO. | PART NO.   |           |
|---------------------------|--------------|-----------|----------|------------|-----------|
| <b>1/4 X 7/16 NOMINAL</b> |              |           |          |            |           |
| .255                      | .4375        | 1/16      | 102401   | TT-400     |           |
| .255                      | .4375        | 1/16      | 402401   | ST-814-2   |           |
| <b>1/4 X 1/2 NOMINAL</b>  |              |           |          |            |           |
| .255                      | .500         | 1/16      | 102402   | TT-504     |           |
| .255                      | .500         | 1/16      | 402402   | ST-816-2   |           |
| <b>1/4 X 5/8 NOMINAL</b>  |              |           |          |            |           |
| .252                      | .628         | 1/16      | 202401   | EW041001   | (TW-25)   |
| .255                      | .625         | 1/16      | 102403   | TT-601     |           |
| .255                      | .625         | 1/16      | 302401   | TB-410     |           |
| .255                      | .625         | 1/16      | 402403   | ST-820-2   |           |
| <b>5/16 X 5/8 NOMINAL</b> |              |           |          |            |           |
| .3145                     | .625         | 1/16      | 102404   | TT-602     |           |
| .315                      | .625         | 1/16      | 402404   | ST-1020-2  |           |
| <b>5/16 X 3/4 NOMINAL</b> |              |           |          |            |           |
| .3145                     | .753         | 1/16      | 202402   | EW051201   | (TW-31)   |
| .315                      | .750         | 1/16      | 102405   | TT-709-1   |           |
| .315                      | .750         | 1/16      | 302402   | TB-512     |           |
| .315                      | .750         | 1/16      | 402405   | ST-1024-2  |           |
| <b>3/8 X 5/8 NOMINAL</b>  |              |           |          |            |           |
| .385                      | .625         | 1/16      | 102406   | TT-604     |           |
| .385                      | .625         | 1/16      | 402406   | ST-1220-2  |           |
| <b>3/8 X 3/4 NOMINAL</b>  |              |           |          |            |           |
| .377                      | .753         | 1/16      | 202403   | EW061201   | (TW-37)   |
|                           |              | 1/8       | 202429   | EW061202   | (TW-38)   |
| .3775                     | .750         | 1/16      | 102407   | TT-710-1   |           |
|                           |              | 1/8       | 102408   | TT-710-2   |           |
| .380                      | .750         | 1/32      | 402407   | ST-1224-1  |           |
|                           |              | 1/16      | 402408   | ST-1224-2  |           |
|                           |              | 1/8       | 402409   | ST-1224-4  |           |
| .390                      | .750         | 1/32      | 102409   | TT-703     |           |
| .390                      | .750         | 1/32      | 302403   | TB-612     |           |
| <b>7/16 X 3/4 NOMINAL</b> |              |           |          |            |           |
| .4385                     | .750         | 1/16      | 102410   | TT-705-1   |           |
| .439                      | .750         | 1/16      | 302418   | TB-712     |           |
| .4395                     | .753         | 1/16      | 202404   | EW071201   | (TW-43)   |
| .440                      | .750         | 1/16      | 402410   | ST-1424-2  |           |
|                           |              | 1/8       | 402411   | ST-1424-4  |           |
| <b>1/2 X 3/4 NOMINAL</b>  |              |           |          |            |           |
| .502                      | .753         | 1/16      | 202405   | EW081201   | (TW-50)   |
| .505                      | .750         | 1/16      | 402412   | ST-1624-2  |           |
| .507                      | .750         | 1/16      | 102411   | TT-706     |           |
| .507                      | .750         | 1/16      | 302404   | TB-812     |           |
| <b>1/2 X 7/8 NOMINAL</b>  |              |           |          |            |           |
| .505                      | .875         | 3/16      | 102412   | TT-801     |           |
| .505                      | .875         | 3/16      | 302405   | TB-814     |           |
| .505                      | .875         | 3/16      | 402413   | ST-1628-6  |           |
| <b>1/2 X 1 NOMINAL</b>    |              |           |          |            |           |
| .502                      | 1.004        | 1/16      | 202406   | EW081601   | (TW-51)   |
|                           |              | 3/32      | 202430   | EW081601.5 | (TW-51.5) |
|                           |              | 1/8       | 202407   | EW081602   | (TW-52)   |
| .510                      | 1.000        | 1/16      | 102413   | TT-1001    |           |
|                           |              | 3/32      | 102414   | TT-1001-2  |           |

| DECIMAL I.D.                 | DECIMAL O.D. | THICKNESS | ITEM NO. | PART NO.  |           |
|------------------------------|--------------|-----------|----------|-----------|-----------|
| .510                         | 1.000        | 1/8       | 102415   | TT-1001-1 |           |
| .510                         | 1.000        | 1/16      | 302406   | TB-816    |           |
| .510                         | 1.000        | 1/16      | 402414   | ST-1632-2 |           |
|                              |              | 3/32      | 402415   | ST-1632-3 |           |
|                              |              | 1/8       | 402416   | ST-1632-4 |           |
| <b>9/16 X 1-1/4 NOMINAL</b>  |              |           |          |           |           |
| .5645                        | 1.254        | 1/16      | 202431   | EW092001  | (TW-55)   |
|                              |              | 1/8       | 202408   | EW092002  | (TW-56)   |
| .565                         | 1.250        | 1/16      | 102416   | TT-1200-1 |           |
|                              |              | 1/8       | 102417   | TT-1200   |           |
| .565                         | 1.250        | 1/8       | 302407   | TB-920    |           |
| .565                         | 1.250        | 1/16      | 402417   | ST-1840-2 |           |
|                              |              | 1/8       | 402418   | ST-1840-4 |           |
| <b>5/8 X 1 NOMINAL</b>       |              |           |          |           |           |
| .627                         | 1.004        | 1/16      | 202409   | EW101601  | (TW-62)   |
|                              |              | 1/8       | 202410   | EW101602  | (TW-63)   |
| .628                         | 1.000        | 1/16      | 102418   | TT-1002-1 |           |
|                              |              | 1/8       | 102419   | TT-1002   |           |
| .628                         | 1.000        | 1/8       | 302408   | TB-1016   |           |
| .628                         | 1.000        | 1/16      | 402419   | ST-2032-2 |           |
|                              |              | 1/8       | 402420   | ST-2032-4 |           |
| <b>5/8 X 1-3/16 NOMINAL</b>  |              |           |          |           |           |
| .627                         | 1.187        | 3/32      | 302409   | TB-1019   |           |
| .627                         | 1.1875       | 1/16      | 102420   | TT-1102-1 |           |
|                              |              | 3/32      | 102421   | TT-1102   |           |
|                              |              | 1/8       | 102422   | TT-1102-2 |           |
| .627                         | 1.1915       | 1/16      | 202432   | EW101901  | (TW-63.5) |
|                              |              | 3/32      | 202411   | EW101902  | (TW-64)   |
|                              |              | 1/8       | 202433   | EW101903  | (TW-64.5) |
| .628                         | 1.1875       | 1/16      | 402421   | ST-2038-2 |           |
|                              |              | 3/32      | 402422   | ST-2038-3 |           |
|                              |              | 1/8       | 402423   | ST-2038-4 |           |
| <b>5/8 X 1-1/4 NOMINAL</b>   |              |           |          |           |           |
| .627                         | 1.254        | 1/16      | 202434   | EW102001  | (TW-64.7) |
|                              |              | 1/8       | 202412   | EW102002  | (TW-65)   |
| .628                         | 1.250        | 1/16      | 102423   | TT-1204   |           |
|                              |              | 1/8       | 102424   | TT-1204-1 |           |
| .628                         | 1.250        | 1/16      | 402424   | ST-2040-2 |           |
|                              |              | 1/8       | 402425   | ST-2040-4 |           |
| .6285                        | 1.250        | 1/8       | 302419   | TB-1020   |           |
| <b>5/8 X 1-1/2 NOMINAL</b>   |              |           |          |           |           |
| .6265                        | 1.500        | 1/8       | 302420   | TB-1024   |           |
| <b>21/32 X 1-1/2 NOMINAL</b> |              |           |          |           |           |
| .656                         | 1.500        | 1/16      | 102425   | TT-1508-1 |           |
|                              |              | 1/8       | 102426   | TT-1508-2 |           |
| .656                         | 1.500        | 1/16      | 402426   | ST-2148-2 |           |
|                              |              | 1/8       | 402427   | ST-2148-4 |           |
| <b>3/4 X 1-1/4 NOMINAL</b>   |              |           |          |           |           |
| .7515                        | 1.250        | 1/8       | 302421   | TB-1220   |           |
| .752                         | 1.254        | 1/16      | 202413   | EW122001  | (TW-75)   |
|                              |              | 1/8       | 202414   | EW122002  | (TW-76)   |
| .753                         | 1.250        | 1/16      | 102427   | TT-1205   |           |
|                              |              | 1/8       | 102428   | TT-1205-1 |           |
| .753                         | 1.250        | 1/16      | 402428   | ST-2440-2 |           |
|                              |              | 1/8       | 402429   | ST-2440-4 |           |

\*Other sizes, tolerances, lubricants and materials are available on special orders.

| DECIMAL I.D.                | DECIMAL O.D. | THICKNESS | ITEM NO. | PART NO.            |
|-----------------------------|--------------|-----------|----------|---------------------|
| <b>3/4 X 1-3/8 NOMINAL</b>  |              |           |          |                     |
| .752                        | 1.375        | 1/8       | 302422   | TB-1222             |
| .752                        | 1.379        | 1/8       | 202415   | EW122202 (TW-77)    |
| .753                        | 1.375        | 1/16      | 102429   | TT-1303-1           |
|                             |              | 1/8       | 102430   | TT-1303-2           |
|                             |              | 1/4       | 102431   | TT-1303-4           |
| .753                        | 1.375        | 1/16      | 402430   | ST-2444-2           |
|                             |              | 1/8       | 402431   | ST-2444-4           |
|                             |              | 1/4       | 402432   | ST-2444-8           |
| <b>3/4 X 1-9/16 NOMINAL</b> |              |           |          |                     |
| .752                        | 1.5675       | 3/32      | 202416   | EW122502 (TW-78)    |
| .765                        | 1.562        | 3/32      | 302410   | TB-1225             |
| .765                        | 1.5625       | 3/32      | 102432   | TT-1501-1           |
| .765                        | 1.5625       | 3/32      | 402433   | ST-2450-3           |
| <b>3/4 X 1-3/4 NOMINAL</b>  |              |           |          |                     |
| .752                        | 1.755        | 1/8       | 202417   | EW122802 (TW-79)    |
| .765                        | 1.750        | 1/8       | 102433   | TT-1701             |
| .765                        | 1.750        | 1/8       | 302411   | TB-1228             |
| .765                        | 1.750        | 1/8       | 402434   | ST-2456-4           |
| <b>7/8 X 1-1/2 NOMINAL</b>  |              |           |          |                     |
| .877                        | 1.504        | 1/16      | 202435   | EW142401 (TW-86)    |
| .877                        | 1.504        | 1/8       | 202418   | EW142402 (TW-87)    |
| .890                        | 1.500        | 1/8       | 302412   | TB-1424             |
| .8905                       | 1.500        | 1/16      | 102434   | TT-1503-2           |
|                             |              | 1/8       | 102435   | TT-1503             |
| .8905                       | 1.500        | 1/16      | 402435   | ST-2848-2           |
|                             |              | 1/8       | 402436   | ST-2848-4           |
| <b>7/8 X 2 NOMINAL</b>      |              |           |          |                     |
| .880                        | 2.000        | 1/8       | 102436   | TT-2007             |
| .880                        | 2.000        | 1/8       | 402437   | ST-2864-4           |
| <b>7/8 X 2-1/8 NOMINAL</b>  |              |           |          |                     |
| .890                        | 2.125        | 1/8       | 302413   | TB-1434             |
| .8905                       | 2.125        | 1/8       | 102437   | TT-2101-1           |
| .8905                       | 2.125        | 1/8       | 402438   | ST-2868-4           |
| <b>1 X 1-1/2 NOMINAL</b>    |              |           |          |                     |
| 1.003                       | 1.500        | 1/16      | 402439   | ST-3248-2           |
|                             |              | 1/8       | 402440   | ST-3248-4           |
|                             |              | 3/16      | 402441   | ST-3248-6           |
| 1.003                       | 1.504        | 1/16      | 102438   | TT-1502-2           |
|                             |              | 1/8       | 102439   | TT-1502             |
|                             |              | 3/16      | 102440   | TT-1502-1           |
| 1.003                       | 1.504        | 1/8       | 302414   | TB-1624             |
| 1.003                       | 1.504        | 1/16      | 202436   | EW162401 (TW-99)    |
| 1.003                       | 1.504        | 1/8       | 202419   | EW162402 (TW-100)   |
| <b>1 X 1-5/8 NOMINAL</b>    |              |           |          |                     |
| 1.003                       | 1.630        | 1/16      | 202437   | EW16260 (TW-100.5)  |
|                             |              | 1/8       | 202420   | EW162602 (TW-101)   |
|                             |              | 1/4       | 202438   | EW162604 (TW-101.5) |
| 1.0155                      | 1.625        | 1/16      | 102441   | TT-1603-3           |
|                             |              | 1/8       | 102442   | TT-1603             |
|                             |              | 1/4       | 102443   | TT-1603-4           |
| 1.0155                      | 1.625        | 1/16      | 402442   | ST-3252-2           |
|                             |              | 1/8       | 402443   | ST-3252-4           |
|                             |              | 1/4       | 402444   | ST-3252-8           |

| DECIMAL I.D.                   | DECIMAL O.D. | THICKNESS                | ITEM NO. | PART NO.            |
|--------------------------------|--------------|--------------------------|----------|---------------------|
| <b>1 X 1-3/4 NOMINAL</b>       |              |                          |          |                     |
| 1.012                          | 1.750        | 1/8                      | 302426   | TB-1628             |
| 1.012                          | 1.750        | 1/16                     | 102444   | TT-1709-1           |
|                                |              | 1/8                      | 102445   | TT-1709             |
| 1.012                          | 1.750        | 1/16                     | 402445   | ST-3256-2           |
|                                |              | 1/8                      | 402446   | ST-3256-4           |
| <b>1 X 2 NOMINAL</b>           |              |                          |          |                     |
| 1.003                          | 2.005        | 1/8                      | 202421   | EW163202 (TW-102)   |
|                                |              | 3/16                     | 202439   | EW163203 (TW-103)   |
| 1.016                          | 2.000        | 1/8                      | 102446   | TT-2001             |
|                                |              | 3/16                     | 102447   | TT-2001-1           |
| 1.016                          | 2.000        | 1/8                      | 302415   | TB-1632             |
|                                |              | 1/8                      | 402447   | ST-3264-4           |
| 1.016                          | 2.000        | 3/16                     | 402448   | ST-3264-6           |
|                                |              | <b>1 X 2-7/8 NOMINAL</b> |          |                     |
| 1.0155                         | 2.875        | 1/8                      | 102448   | TT-2800             |
| 1.0155                         | 2.875        | 1/8                      | 402449   | ST-3292-4           |
| <b>1-1/16 X 2-3/8 NOMINAL</b>  |              |                          |          |                     |
| 1.0625                         | 2.375        | 1/16                     | 102449   | TT-2301-4           |
|                                |              | 1/8                      | 102450   | TT-2301-3           |
| 1.0625                         | 2.375        | 1/16                     | 402450   | ST-3476-2           |
|                                |              | 1/8                      | 402451   | ST-3476-4           |
| <b>1-1/8 X 1-7/8 NOMINAL</b>   |              |                          |          |                     |
| 1.140                          | 1.875        | 1/8                      | 102451   | TT-1800-1           |
| 1.140                          | 1.875        | 1/8                      | 402452   | ST-3660-4           |
| <b>1-1/4 X 1-11/16 NOMINAL</b> |              |                          |          |                     |
| 1.253                          | 1.690        | 1/8                      | 102452   | TT-1602             |
| 1.253                          | 1.690        | 1/8                      | 402453   | ST-4054-4           |
| 1.2535                         | 1.6925       | 1/8                      | 202422   | EW202702 (TW-125)   |
| <b>1-1/4 X 1-3/4 NOMINAL</b>   |              |                          |          |                     |
| 1.253                          | 1.750        | 1/8                      | 302416   | TB-2028             |
| <b>1-1/4 X 2 NOMINAL</b>       |              |                          |          |                     |
| 1.2535                         | 2.005        | 1/16                     | 202440   | EW203201 (TW-126.5) |
|                                |              | 1/8                      | 202423   | EW203202 (TW-126)   |
| 1.265                          | 2.000        | 1/16                     | 102453   | TT-2006             |
|                                |              | 1/8                      | 102454   | TT-2006-1           |
| 1.265                          | 2.000        | 1/16                     | 402454   | ST-4064-2           |
|                                |              | 1/8                      | 402455   | ST-4064-4           |
| <b>1-1/4 X 2-3/8 NOMINAL</b>   |              |                          |          |                     |
| 1.265                          | 2.375        | 1/16                     | 102455   | TT-2304-1           |
|                                |              | 1/8                      | 102456   | TT-2304-2           |
| 1.265                          | 2.375        | 1/16                     | 402456   | ST-4076-2           |
|                                |              | 1/8                      | 402457   | ST-4076-4           |
| <b>1-1/4 X 3-5/16 NOMINAL</b>  |              |                          |          |                     |
| 1.255                          | 3.312        | 1/16                     | 102457   | TT-3301             |
|                                |              | 1/8                      | 102458   | TT-3301-1           |
| 1.255                          | 3.312        | 1/16                     | 402458   | ST-40106-2          |
|                                |              | 1/8                      | 402459   | ST-40106-4          |
| <b>1-3/8 X 1-15/16 NOMINAL</b> |              |                          |          |                     |
| 1.379                          | 1.940        | 1/8                      | 102459   | TT-1900             |
| 1.379                          | 1.940        | 1/8                      | 402460   | ST-4462-4           |

\*Other sizes, tolerances, lubricants and materials are available on special orders.

| DECIMAL I.D.                   | DECIMAL O.D. | THICKNESS | ITEM NO. | PART NO.          |
|--------------------------------|--------------|-----------|----------|-------------------|
| <b>1-1/2 X 2 NOMINAL</b>       |              |           |          |                   |
| 1.503                          | 2.000        | 1/8       | 102460   | TT-2008           |
| 1.503                          | 2.000        | 1/8       | 402461   | ST-4864-4         |
| <b>1-1/2 X 2-1/2 NOMINAL</b>   |              |           |          |                   |
| 1.504                          | 2.505        | 1/8       | 202424   | EW244002 (TW-150) |
| 1.505                          | 2.505        | 1/8       | 302434   | TB-2440           |
| 1.505                          | 2.505        | 1/8       | 402462   | ST-4880-4         |
| <b>1-1/2 X 3-1/2 NOMINAL</b>   |              |           |          |                   |
| 1.504                          | 3.507        | 3/16      | 202425   | EW245603 (TW-151) |
| 1.510                          | 3.500        | 3/16      | 102461   | TT-3500-1         |
| 1.510                          | 3.500        | 3/16      | 302417   | TB-2456           |
| 1.510                          | 3.500        | 3/16      | 402463   | ST-48112-6        |
| <b>1-9/16 X 2-7/16 NOMINAL</b> |              |           |          |                   |
| 1.578                          | 2.4375       | 1/8       | 102462   | TT-2402           |
| 1.578                          | 2.4375       | 1/8       | 402464   | ST-5078-4         |
| <b>1-3/4 X 2-7/16 NOMINAL</b>  |              |           |          |                   |
| 1.755                          | 2.440        | 1/8       | 102463   | TT-2400-1         |
| 1.755                          | 2.440        | 1/8       | 402465   | ST-5678-4         |
| <b>1-3/4 X 2-5/8 NOMINAL</b>   |              |           |          |                   |
| 1.754                          | 2.631        | 1/8       | 202426   | EW284202 (TW-175) |
| 1.765                          | 2.625        | 1/8       | 102464   | TT-2601           |
| 1.765                          | 2.625        | 1/8       | 402466   | ST-5684-4         |
| <b>1-15/16 X 2-5/8 NOMINAL</b> |              |           |          |                   |
| 1.953                          | 2.625        | 1/8       | 102465   | TT-2600           |
| 1.953                          | 2.625        | 1/8       | 402467   | ST-6284-4         |
| <b>2 X 3 NOMINAL</b>           |              |           |          |                   |
| 2.004                          | 3.00         | 1/8       | 202427   | EW324802 (TW-200) |
|                                |              | 1/4       | 202428   | EW324804 (TW-201) |
| 2.010                          | 3.000        | 1/8       | 102467   | TT-3001-3         |
|                                |              | 3/16      | 102466   | TT-3001           |
|                                |              | 1/4       | 102468   | TT-3001-1         |
| 2.011                          | 3.000        | 1/8       | 402468   | ST-6496-4         |
|                                |              | 3/16      | 402469   | ST-6496-6         |
|                                |              | 1/4       | 402470   | ST-6496-8         |
| <b>2 X 3-5/8 NOMINAL</b>       |              |           |          |                   |
| 2.031                          | 3.625        | 3/16      | 102469   | TT-3600           |
| 2.031                          | 3.625        | 3/16      | 402471   | ST-64116-6        |
| <b>2-1/16 X 4 NOMINAL</b>      |              |           |          |                   |
| 2.062                          | 4.000        | 1/8       | 102470   | TT-4002-1         |
| 2.062                          | 4.000        | 1/4       | 102471   | TT-4002           |
| 2.062                          | 4.000        | 1/8       | 402472   | ST-66128-4        |
| 2.062                          | 4.000        | 1/4       | 402473   | ST-66128-8        |
| <b>2-1/2 X 3-1/4 NOMINAL</b>   |              |           |          |                   |
| 2.502                          | 3.250        | 1/8       | 102472   | TT-3200           |
| 2.502                          | 3.250        | 1/8       | 402474   | ST-80104-4        |
| <b>2-3/4 X 3-7/8 NOMINAL</b>   |              |           |          |                   |
| 2.766                          | 3.875        | 1/4       | 102473   | TT-3800           |
| 2.766                          | 3.875        | 1/4       | 402475   | ST-88124-8        |

\*Other sizes, tolerances, lubricants and materials are available on special orders.



### CORED BAR STOCK

| I.D.  | O.D.  | LENGTH | ITEM NO. | PART NO.  |
|-------|-------|--------|----------|-----------|
| 1/2   | 1     | 6-1/2  | 102601   | CC-1000-2 |
|       | 1-1/8 | 6-1/2  | 102602   | CC-1103   |
|       | 1-1/4 | 6-1/2  | 102603   | CC-1203   |
|       | 1-1/2 | 6-1/2  | 102604   | CC-1502   |
|       | 2     | 6-1/2  | 102605   | CC-2005   |
| 5/8   | 1     | 6-1/2  | 102606   | CC-1001   |
|       | 1-1/8 | 6-1/2  | 102607   | CC-1101-1 |
|       | 1-1/4 | 6-1/2  | 102608   | CC-1200-1 |
|       | 1-3/8 | 6-1/2  | 102609   | CC-1302   |
|       | 1-1/2 | 6-1/2  | 102610   | CC-1503   |
|       | 1-3/4 | 6-1/2  | 102611   | CC-1703   |
|       | 2     | 6-1/2  | 102612   | CC-2006   |
|       | 3/4   | 1-1/4  | 6-1/2    | 102613    |
| 1-1/2 |       | 6-1/2  | 102614   | CC-1500-1 |
| 1-3/4 |       | 6-1/2  | 102615   | CC-1702   |
| 2     |       | 6-1/2  | 102616   | CC-2001   |
| 2-1/4 |       | 6-1/2  | 102617   | CC-2206   |
| 2-1/2 |       | 6-1/2  | 102618   | CC-2504   |
| 2-3/4 |       | 6-1/2  | 102619   | CC-2704   |
| 7/8   | 1-3/8 | 6-1/2  | 102620   | CC-1301   |
|       | 1-1/2 | 6-1/2  | 102621   | CC-1504   |
|       | 2     | 6-1/2  | 102622   | CC-2007   |
|       | 2-1/4 | 6-1/2  | 102623   | CC-2207   |
| 1     | 1-1/2 | 6-1/2  | 102624   | CC-1501   |
|       | 1-5/8 | 6-1/2  | 102625   | CC-1600-1 |
|       | 1-3/4 | 6-1/2  | 102626   | CC-1700-2 |
|       | 2     | 6-1/2  | 102627   | CC-2002   |
|       | 2-1/4 | 6-1/2  | 102628   | CC-2202-2 |
|       | 2-1/2 | 6-1/2  | 102629   | CC-2501   |
|       | 3     | 6-1/2  | 102630   | CC-3001   |
|       | 3-1/2 | 6-1/2  | 102631   | CC-3504   |
| 1-1/8 | 2-1/8 | 6-1/2  | 102633   | CC-2102   |
|       | 1-1/4 | 1-3/4  | 6-1/2    | 102634    |
| 2     |       | 6-1/2  | 102635   | CC-2000-1 |
| 2-1/4 |       | 6-1/2  | 102636   | CC-2203   |
| 2-1/2 |       | 6-1/2  | 102637   | CC-2502   |
| 3     |       | 6-1/2  | 102638   | CC-3003   |
| 1-3/8 | 2     | 6-1/2  | 102639   | CC-3505   |
|       | 4     | 6-1/2  | 102640   | CC-4005   |
|       | 2     | 6-1/2  | 102641   | CC-2003   |
|       | 2-3/4 | 6-1/2  | 102642   | CC-2702   |
| 1-1/2 | 2     | 6-1/2  | 102643   | CC-2004   |
|       | 2-1/4 | 6-1/2  | 102644   | CC-2200-1 |
|       | 2-1/2 | 6-1/2  | 102645   | CC-2503   |
|       | 2-3/4 | 6-1/2  | 102646   | CC-2701   |
|       | 3     | 6-1/2  | 102647   | CC-3002   |
|       | 3-1/2 | 6-1/2  | 102648   | CC-3502   |
|       | 4     | 6-1/2  | 102649   | CC-4007   |
| 1-3/4 | 2-1/4 | 6-1/2  | 102650   | CC-2201-3 |
|       | 2-1/2 | 6-1/2  | 102651   | CC-2500-1 |
|       | 2-5/8 | 6-1/2  | 102652   | CC-2604   |
|       | 2-3/4 | 6-1/2  | 102653   | CC-2703   |
|       | 3     | 6-1/2  | 102654   | CC-3005   |
|       | 3-1/2 | 6-1/2  | 102655   | CC-3503   |
|       | 4-1/4 | 6-1/2  | 102656   | CC-4202   |
| 4-1/2 | 6-1/2 | 102657 | CC-4502  |           |

### SOLID BAR STOCK

| I.D.  | O.D.  | LENGTH | ITEM NO. | PART NO.  |           |
|-------|-------|--------|----------|-----------|-----------|
| 2     | 2-3/4 | 6-1/2  | 102658   | CC-2700-1 |           |
|       | 3     | 6-1/2  | 102659   | CC-3000   |           |
|       | 3-1/4 | 6-1/2  | 102660   | CC-3201-2 |           |
|       | 4     | 6-1/2  | 102661   | CC-4003   |           |
|       | 4-1/2 | 6-1/2  | 102662   | CC-4501   |           |
|       | 5     | 6-1/2  | 102663   | CC-5000   |           |
|       | 5-1/2 | 6-1/2  | 102664   | CC-5500   |           |
|       | 2-1/4 | 3      | 6-1/2    | 102665    | CC-3006   |
|       |       | 3-1/4  | 6-1/2    | 102666    | CC-3202-1 |
|       |       | 3-1/2  | 6-1/2    | 102667    | CC-3500-1 |
| 3-3/4 |       | 6-1/2  | 102668   | CC-3703   |           |
| 4     |       | 6-1/2  | 102669   | CC-4008   |           |
| 2-3/8 | 4-1/2 | 6-1/2  | 102670   | CC-4503   |           |
|       | 3     | 6-1/2  | 102671   | CC-3007   |           |
|       | 3-1/2 | 6-1/2  | 102672   | CC-3507   |           |
|       | 4     | 6-1/2  | 102673   | CC-4009   |           |
|       | 4-1/2 | 6-1/2  | 102674   | CC-4504   |           |
| 2-1/2 | 3-1/2 | 6-1/2  | 102675   | CC-3501   |           |
|       | 3-3/4 | 6-1/2  | 102676   | CC-3702   |           |
|       | 4     | 6-1/2  | 102677   | CC-4010   |           |
|       | 4-1/4 | 6-1/2  | 102678   | CC-4203   |           |
|       | 4-1/2 | 6-1/2  | 102679   | CC-4505   |           |
| 2-3/4 | 5     | 6-1/2  | 102680   | CC-5001   |           |
|       | 3-3/4 | 6-1/2  | 102681   | CC-3700-1 |           |
|       | 3     | 6-1/2  | 102682   | CC-3701-1 |           |
|       | 4     | 6-1/2  | 102683   | CC-4001   |           |
|       | 4-1/2 | 6-1/2  | 102684   | CC-4506   |           |
|       | 5     | 6-1/2  | 102685   | CC-5002   |           |
| 3-1/4 | 6     | 6-1/2  | 102686   | CC-6000   |           |
|       | 4-1/4 | 6-1/2  | 102688   | CC-4200-1 |           |
|       | 4-3/4 | 6-1/2  | 102689   | CC-4700-2 |           |
| 3-1/2 | 5     | 6-1/2  | 102690   | CC-5003   |           |
|       | 6     | 6-1/2  | 102691   | CC-6002   |           |
|       | 3-3/4 | 5      | 6-1/2    | 102692    | CC-5004   |
| 4     | 5-1/2 | 6-1/2  | 102693   | CC-5501   |           |
|       | 6     | 6-1/2  | 102694   | CC-6001   |           |
|       | 7     | 6-1/2  | 102695   | CC-7001   |           |
|       | 8     | 6-1/2  | 102696   | CC-8000   |           |
|       | 4-1/2 | 6      | 6-1/2    | 102697    | CC-6003   |
| 5     | 7     | 6-1/2  | 102698   | CC-7000   |           |
|       | 6     | 8      | 6-1/2    | 102699    | CC-8001   |
|       | 7-3/4 | 10-3/8 | 6-1/8†   | 102702    | CC-10301  |

† Modified Lengths

| O.D.  | LENGTH | ITEM NO. | PART NO.  |
|-------|--------|----------|-----------|
| 1/4   | 2      | 102801   | BB-200    |
| 3/8   | 3      | 102802   | BB-302    |
| 1/2   | 6-1/2  | 102803   | BB-500    |
| 5/8   | 6-1/2  | 102804   | BB-600-1  |
| 3/4   | 6-1/2  | 102805   | BB-700-1  |
| 7/8   | 6-1/2  | 102806   | BB-800-1  |
| 1     | 6-1/2  | 102807   | BB-1000-2 |
| 1-1/8 | 6-1/2  | 102808   | BB-1100   |
| 1-1/4 | 6-1/2  | 102809   | BB-1200-1 |
| 1-3/8 | 6-1/2  | 102810   | BB-1300   |
| 1-1/2 | 6-1/2  | 102811   | BB-1500-2 |
| 1-5/8 | 6-1/2  | 102812   | BB-1600   |
| 1-3/4 | 6-1/2  | 102813   | BB-1700-1 |
| 2     | 6-1/2  | 102814   | BB-2000-1 |
| 2-1/4 | 6-1/2  | 102815   | BB-2200   |
| 2-1/2 | 6-1/2  | 102816   | BB-2500-1 |
| 2-3/4 | 6-1/2  | 102817   | BB-2700-1 |
| 3     | 6-1/2  | 102818   | BB-3000-1 |
| 3-1/4 | 6-1/2  | 102819   | BB-3200-2 |
| 3-1/2 | 6-1/2  | 102820   | BB-3500-1 |
| 4     | 6-1/2  | 102821   | BB-4000-1 |
| 4-1/2 | 6-1/2  | 102822   | BB-4500   |
| 5     | 6-1/2  | 102823   | BB-5000   |
| 5-1/2 | 6-1/2  | 102824   | BB-5500   |
| 6     | 6-1/2  | 102825   | BB-6000   |
| 7     | 6-1/2  | 102826   | BB-7000   |

All sintered bars will finish to size shown.



ISOSTATIC INDUSTRIES INC., CHICAGO, IL

800-621-5500

**POWDERED METAL BRONZE BEARINGS STOCK SIZES  
(Discs - Circular Bearing Plates)**



| I.D.  | O.D.  | THICKNESS<br>± .010" | ITEM<br>NO. | PART<br>NO. |
|-------|-------|----------------------|-------------|-------------|
|       | 3     | 1/4                  | 103001      | DD-3000     |
|       | 3     | 3/8                  | 103002      | DD-3000-1   |
|       | 4     | 1/4                  | 103003      | DD-4000     |
|       | 5-5/8 | †1/4                 | 103004      | DD-5602-1   |
|       | 6     | ‡5/16                | 103005      | DD-6000     |
|       | 7     | ‡5/16                | 103006      | DD-7001     |
|       | 8     | ‡5/16                | 103007      | DD-8000     |
|       | 8     | ‡3/8                 | 103008      | DD-8000-3   |
| 1     | 3     | 1/4                  | 103101      | CD-3001     |
| 1     | 4     | 1/4                  | 103102      | CD-4001     |
| 2     | 4     | 1/4                  | 103103      | CD-4002     |
| 2     | 5-1/2 | †1/4                 | 103104      | CD-5500     |
| 2-1/4 | 4-1/2 | †1/4                 | 103105      | CD-4502     |
| 2-1/4 | 7     | †1/4                 | 103106      | CD-7000-2   |
| 3     | 9     | ‡5/16                | 103107      | CD-9001     |
| 4     | 6     | ‡5/16                | 103108      | CD-6003     |

†Thickness ± .0035"

‡Thickness ± .005"

I.D. and O.D. will finish to dimensions shown.

**RECTANGULAR PLATE STOCK**



| W            | L     | THICKNESS<br>± .010" | ITEM<br>NO. | PART<br>NO. |
|--------------|-------|----------------------|-------------|-------------|
| <b>PLATE</b> |       |                      |             |             |
| 1/2          | 2-1/2 | 1/4                  | 102901      | PP-2500     |
| 2            | 8-1/8 | 1/4                  | 102903      | PP-8100-1   |
| 2            | 8-1/8 | 1/2                  | 102904      | PP-8100     |
| 3            | 12    | 1/4                  | 102905      | PP-12100    |
| 3            | 12    | 1/2                  | 102906      | PP-12100-1  |
| 3            | 12    | 3/4                  | 102907      | PP-12100-2  |
| 3            | 12    | 1                    | 102908      | PP-12100-3  |
| 5            | 6     | 1/8                  | 102909      | PP-6000     |
| 5            | 6     | 3/16                 | 102910      | PP-6000-1   |
| 5            | 6     | 1/4                  | 102911      | PP-6000-2   |
| 5            | 6     | 3/8                  | 102912      | PP-6000-4   |
| 5            | 6     | 1/2                  | 102913      | PP-6000-5   |
| 5            | 6     | 5/8                  | 102914      | PP-6000-6   |
| 5            | 6     | 3/4                  | 102915      | PP-6000-7   |
| 5            | 6     | 1                    | 102916      | PP-6000-8   |
| 5            | 8     | 1/8                  | 102917      | PP-8000-7   |
| 5            | 8     | 1/4                  | 102919      | PP-8000-1   |
| 5            | 8     | 1/2                  | 102920      | PP-8000-4   |
| 5            | 8     | 3/4                  | 102921      | PP-8000-5   |
| 5            | 8     | 1                    | 102922      | PP-8000-6   |
| 6            | 12    | 1/8                  | 102923      | PP-12000-6  |
| 6            | 12    | 3/16                 | 102924      | PP-12000-7  |
| 6            | 12    | 1/4                  | 102925      | PP-12000    |
| 6            | 12    | 3/8                  | 102926      | PP-12000-1  |
| 6            | 12    | 1/2                  | 102927      | PP-12000-2  |
| 6            | 12    | 5/8                  | 102928      | PP-12000-3  |
| 6            | 12    | 3/4                  | 102929      | PP-12000-4  |
| 6            | 12    | 1                    | 102930      | PP-12000-5  |

Width & length will finish to size shown.

**SUPER OILUBE BAR STOCK - 5" LENGTH SAE 863  
18-22% COPPER - BALANCE IRON**

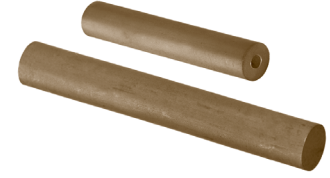

| I.D.         | O.D.    | LENGTH | ITEM<br>NO. | PART<br>NO. |
|--------------|---------|--------|-------------|-------------|
| <b>CORED</b> |         |        |             |             |
| 1/2          | 1       | 5      | 103301      | SSC-1000    |
| 1/2          | 1-7/16  | 5      | 103302      | SSC-1402    |
| 3/4          | 1-3/16  | 5      | 103304      | SSC-1102    |
| 3/4          | 1-9/16  | 5      | 103305      | SSC-1500    |
| 3/4          | 1-15/16 | 5      | 103306      | SSC-1900    |
| 1            | 1-11/16 | 5      | 103310      | SSC-1601    |
| 1            | 2-3/16  | 5      | 103311      | SSC-2100    |
| 1-1/4        | 1-11/16 | 5      | 103312      | SSC-1602    |
| 1-1/4        | 2-3/16  | 5      | 103313      | SSC-2103    |
| 1-1/4        | 2-7/8   | 5      | 103314      | SSC-2803    |
| 1-1/2        | 1-15/16 | 5      | 103316      | SSC-1904    |
| 1-1/2        | 3-7/8   | 5      | 103319      | SSC-3805    |
| 1-3/4        | 2-1/2   | 5      | 103320      | SSC-2504    |
| 1-3/4        | 3       | 5      | 103321      | SSC-3004    |
| 2            | 2-5/8   | 5      | 103323      | SSC-2600    |
| 2            | 3       | 5      | 103324      | SSC-3005    |
| 2-1/2        | 3-3/8   | 5      | 103327      | SSC-3301    |
| 2-1/2        | 4-1/8   | 5      | 103328      | SSC-4102    |
| 3            | 4-7/8   | 5      | 103331      | SSC-4802    |
| <b>SOLID</b> |         |        |             |             |
|              | 3/8     | 2-1/2  | 103401      | SSS-300     |
|              | 1/2     | 6-1/2  | 103402      | SSS-500     |
|              | 5/8     | 5      | 103403      | SSS-600     |
|              | 3/4     | 5      | 103404      | SSS-700     |
|              | 7/8     | 5      | 103405      | SSS-800     |
|              | 1       | 5      | 103406      | SSS-1000    |
|              | 1-3/16  | 5      | 103407      | SSS-1100    |
|              | 1-5/16  | 5      | 103408      | SSS-1300    |
|              | 1-7/16  | 5      | 103409      | SSS-1400    |
|              | 1-9/16  | 5      | 103410      | SSS-1500    |
|              | 1-13/16 | 5      | 103411      | SSS-1800    |
|              | 2-1/16  | 5      | 103412      | SSS-2000    |
|              | 2-7/8   | 5      | 103413      | SSS-2800    |

Bar stock will finish to sizes shown.

\*Other sizes, tolerances, lubricants and materials are available on special orders.

## LOADS and SPEEDS

The normal load carrying capacity of OILUBE bearings is expressed as a PV factor (Pressure x Surface Velocity) where —

P = the load in psi on the projected bearing area (Bearing ID x Length).

V = surface velocity of the shaft in feet per minute (sfm)

$$PV = \frac{W}{LD} \times \frac{\pi DN}{12} = \frac{3.14 WN}{12L}$$

W = total load on bearing (pound)

L = bearing length (inches)

D = ID of bearing (inches)

N = shaft speed (rpm)

## Normal Upper Limits of OILUBE Bearing Material

| PV     | Static (psi) | Dynamic (psi) | Velocity (sfm) |
|--------|--------------|---------------|----------------|
| 50,000 | 8,000        | 2,000         | 1,200          |

## Normal Limits of Bearing Length

| Material                                                     | Length to I.D. Ratio | Length to Wall Thickness Ratio |
|--------------------------------------------------------------|----------------------|--------------------------------|
| Oilube Bronze                                                | 4 to 1               | 24 to 1                        |
| For ratios greater than those shown above please contact us. |                      |                                |

## OILUBE BRONZE METRIC TOLERANCES

| Nominal Sizes (mm)             |    | Tolerances (in 0.001mm) |            |
|--------------------------------|----|-------------------------|------------|
| Over                           | To | I.D.                    | O.D.       |
| 3                              | 5  | +20<br>+0               | +40<br>+19 |
| 6                              | 10 | +30<br>+05              | +40<br>+19 |
| 10                             | 18 | +30<br>+05              | +50<br>+28 |
| 18                             | 30 | +30<br>+05              | +60<br>+35 |
| 30                             | 50 | +40<br>+09              | +70<br>+40 |
| 50                             | 65 | +40<br>+10              | +83<br>+50 |
| <b>Overall Length</b>          |    |                         |            |
| Up                             | to | 40mm                    | ± 0.12mm   |
| 40mm                           | to | 55mm                    | ± 0.19mm   |
| 55mm                           | to | 76mm                    | ± 0.25mm   |
| <b>Flange Outside diameter</b> |    |                         |            |
| Up                             | to | 30mm                    | ± 0.12mm   |
| 30mm                           | to | 70mm                    | ± 0.25mm   |
| <b>Flange Thickness</b>        |    |                         |            |
| Up                             | to | 3mm                     | ± 0.07mm   |
| 3mm                            | to | 5mm                     | ± 0.13mm   |
| <b>Concentricity</b>           |    |                         |            |
| Up                             | to | 40mm                    | 0.07mm     |
| 40mm                           | to | 65mm                    | 0.10mm     |
| 65mm                           | to | 100mm                   | 0.13mm     |
| OVER                           | to | 100mm                   | 0.18mm     |

These manufacturing tolerances are the result of a compromise between ASTM-B438-73, and common ISO tolerances for G7-s7. Consider housing bores H7, assembly arbors n6, and shafts f7.

## OILUBE MATERIAL SPECIFICATIONS

| Composition %                                                                          | Density (gm/cc) | Porosity (% by Volume) | K Strength Constant | Tensile Strength | Elongation (in 1"%) | Yield Strength PSI | Comparable Designations                                                                       |
|----------------------------------------------------------------------------------------|-----------------|------------------------|---------------------|------------------|---------------------|--------------------|-----------------------------------------------------------------------------------------------|
| Copper 87.5-90.5<br>Tin 9.5-10.5<br>Iron 1.0 max.<br>Carbon 1.75<br>Other Elements 0.5 | 6.4-6.8         | 19 min.                | 26500               | 14000            | 1                   | 11000              | ASTM B-438-70<br>GR1 Type II<br>MPIF CT-1000-K26<br>Mil-B-5687C<br>Type I, Comp. A<br>SAE-841 |

\*Other sizes, tolerances, lubricants and materials are available on special orders.



| I.D.<br>(mm) | O.D.<br>(mm) | Length<br>(mm) | Item<br>Number | Part<br>Number |
|--------------|--------------|----------------|----------------|----------------|
| 2            | 5            | 2              | 601003         | AM-205-2       |
|              |              | 3              | 601004         | AM-205-3       |
| 3            | 6            | 4              | 601006         | AM-306-4       |
|              |              | 5              | 601007         | AM-306-5       |
|              |              | 6              | 601008         | AM-306-6       |
|              |              | 10             | 601009         | AM-306-10      |
| 4            | 6            | 8              | 601012         | AM-406-8       |
|              |              | 10             | 601013         | AM-406-10      |
|              |              | 17             | 601014         | AM-406-17      |
| 4            | 7            | 4              | 601015         | AM-407-4       |
|              |              | 8              | 601016         | AM-407-8       |
|              |              | 10             | 601017         | AM-407-10      |
|              |              | 12             | 601018         | AM-407-12      |
| 4            | 8            | 4              | 601020         | AM-408-4       |
|              |              | 6              | 601021         | AM-408-6       |
|              |              | 8              | 601022         | AM-408-8       |
|              |              | 10             | 601023         | AM-408-10      |
|              |              | 12             | 601024         | AM-408-12      |
| 5            | 7            | 7              | 601028         | AM-507-7       |
| 5            | 8            | 5              | 601029         | AM-508-5       |
|              |              | 8              | 601030         | AM-508-8       |
|              |              | 10             | 601031         | AM-508-10      |
|              |              | 12             | 601032         | AM-508-12      |
|              |              | 15             | 601033         | AM-508-15      |
|              |              | 16             | 601034         | AM-508-16      |
| 5            | 9            | 4              | 601035         | AM-509-4       |
|              |              | 5              | 601036         | AM-509-5       |
|              |              | 8              | 601037         | AM-509-8       |
| 6            | 9            | 4              | 601047         | AM-609-4       |
|              |              | 6              | 601048         | AM-609-6       |
|              |              | 8              | 601049         | AM-609-8       |
|              |              | 10             | 601050         | AM-609-10      |
|              |              | 12             | 601051         | AM-609-12      |
|              |              | 15             | 601052         | AM-609-15      |
| 6            | 10           | 4              | 601055         | AM-610-4       |
|              |              | 6              | 601056         | AM-610-6       |
|              |              | 10             | 601058         | AM-610-10      |
|              |              | 12             | 601059         | AM-610-12      |
|              |              | 14             | 601060         | AM-610-14      |
|              |              | 16             | 601061         | AM-610-16      |
| 6            | 12           | 6              | 601062         | AM-612-6       |
|              |              | 8              | 601063         | AM-612-8       |
|              |              | 10             | 601064         | AM-612-10      |
|              |              | 11             | 601065         | AM-612-11      |
|              |              | 12             | 601066         | AM-612-12      |
|              |              | 15             | 601067         | AM-612-15      |
|              |              | 16             | 601068         | AM-612-16      |
|              |              | 25             | 601069         | AM-612-25      |
|              |              | 7              | 10             | 5              |
| 8            | 601073       |                |                | AM-710-8       |
| 10           | 601074       |                |                | AM-710-10      |
| 8            | 10           | 8              | 601080         | AM-810-8       |
|              |              | 10             | 601081         | AM-810-10      |
| 8            | 11           | 8              | 601083         | AM-811-8       |
|              |              | 12             | 601084         | AM-811-12      |
|              |              | 16             | 601085         | AM-811-16      |
|              |              | 20             | 601086         | AM-811-20      |
| 8            | 12           | 6              | 601087         | AM-812-6       |
|              |              | 8              | 601088         | AM-812-8       |
|              |              | 10             | 601089         | AM-812-10      |
|              |              | 12             | 601090         | AM-812-12      |
|              |              | 14             | 601091         | AM-812-14      |

| I.D.<br>(mm) | O.D.<br>(mm) | Length<br>(mm) | Item<br>Number | Part<br>Number |
|--------------|--------------|----------------|----------------|----------------|
| 8            | 12           | 16             | 601092         | AM-812-16      |
|              |              | 20             | 601093         | AM-812-20      |
| 8            | 14           | 8              | 601097         | AM-814-8       |
|              |              | 12             | 601098         | AM-814-12      |
|              |              | 14             | 601099         | AM-814-14      |
|              |              | 16             | 601100         | AM-814-16      |
|              |              | 20             | 601101         | AM-814-20      |
| 9            | 12           | 6              | 601105         | AM-912-6       |
|              |              | 10             | 601106         | AM-912-10      |
|              |              | 14             | 601107         | AM-912-14      |
| 10           | 12           | 10             | 601113         | AM-1012-10     |
|              |              | 11             | 601114         | AM-1012-11     |
|              |              | 20             | 601115         | AM-1012-20     |
| 10           | 13           | 10             | 601116         | AM-1013-10     |
|              |              | 12             | 601117         | AM-1013-12     |
|              |              | 16             | 601118         | AM-1013-16     |
|              |              | 18             | 601119         | AM-1013-18     |
|              |              | 20             | 601120         | AM-1013-20     |
|              |              | 25             | 601121         | AM-1013-25     |
| 10           | 14           | 8              | 601122         | AM-1014-8      |
|              |              | 10             | 601123         | AM-1014-10     |
|              |              | 14             | 601124         | AM-1014-14     |
|              |              | 15             | 601125         | AM-1014-15     |
|              |              | 16             | 601126         | AM-1014-16     |
|              |              | 18             | 601127         | AM-1014-18     |
| 10           | 15           | 20             | 601128         | AM-1014-20     |
|              |              | 25             | 601129         | AM-1014-25     |
|              |              | 10             | 601130         | AM-1015-10     |
|              |              | 16             | 601131         | AM-1015-16     |
|              |              | 20             | 601132         | AM-1015-20     |
| 10           | 16           | 25             | 601133         | AM-1015-25     |
|              |              | 8              | 601134         | AM-1016-8      |
|              |              | 10             | 601135         | AM-1016-10     |
|              |              | 15             | 601136         | AM-1016-15     |
|              |              | 16             | 601137         | AM-1016-16     |
|              |              | 20             | 601138         | AM-1016-20     |
| 12           | 14           | 25             | 601139         | AM-1016-25     |
|              |              | 30             | 601140         | AM-1016-30     |
|              |              | 9              | 601145         | AM-1214-9      |
|              |              | 12             | 601146         | AM-1214-12     |
|              |              | 14             | 601147         | AM-1214-14     |
| 12           | 15           | 16             | 601148         | AM-1214-16     |
|              |              | 8              | 601149         | AM-1215-8      |
|              |              | 12             | 601150         | AM-1215-12     |
|              |              | 16             | 601153         | AM-1215-16     |
|              |              | 18             | 601154         | AM-1215-18     |
|              |              | 20             | 601155         | AM-1215-20     |
|              |              | 25             | 601156         | AM-1215-25     |
|              |              | 8              | 601157         | AM-1216-8      |
| 12           | 16           | 12             | 601158         | AM-1216-12     |
|              |              | 15             | 601159         | AM-1216-15     |
|              |              | 16             | 601160         | AM-1216-16     |
|              |              | 20             | 601161         | AM-1216-20     |
|              |              | 25             | 601162         | AM-1216-25     |
| 12           | 17           | 27             | 601163         | AM-1216-27     |
|              |              | 10             | 601165         | AM-1217-10     |
|              |              | 12             | 601166         | AM-1217-12     |
|              |              | 16             | 601167         | AM-1217-16     |
|              |              | 18             | 601168         | AM-1217-18     |
|              |              | 20             | 601169         | AM-1217-20     |
| 12           | 18           | 25             | 601171         | AM-1217-25     |
|              |              | 8              | 601172         | AM-1218-8      |
|              |              | 10             | 601173         | AM-1218-10     |
|              |              | 12             | 601174         | AM-1218-12     |

\*Other sizes, tolerances, lubricants and materials are available on special orders.



| I.D. (mm) | I.D. (mm) | Length (mm) | Item Number | Part Number |
|-----------|-----------|-------------|-------------|-------------|
| 12        | 18        | 16          | 601175      | AM-1218-16  |
|           |           | 18          | 601176      | AM-1218-18  |
|           |           | 20          | 601177      | AM-1218-20  |
|           |           | 25          | 601178      | AM-1218-25  |
| 14        | 18        | 10          | 601184      | AM-1418-10  |
|           |           | 14          | 601185      | AM-1418-14  |
|           |           | 15          | 601186      | AM-1418-15  |
|           |           | 18          | 601187      | AM-1418-18  |
|           |           | 19          | 601188      | AM-1418-19  |
|           |           | 20          | 601189      | AM-1418-20  |
|           |           | 22          | 601190      | AM-1418-22  |
|           |           | 26          | 601191      | AM-1418-26  |
|           |           | 28          | 601192      | AM-1418-28  |
| 14        | 20        | 10          | 601193      | AM-1420-10  |
|           |           | 12          | 601194      | AM-1420-12  |
|           |           | 14          | 601195      | AM-1420-14  |
|           |           | 15          | 601196      | AM-1420-15  |
|           |           | 18          | 601197      | AM-1420-18  |
|           |           | 20          | 601198      | AM-1420-20  |
|           |           | 22          | 601199      | AM-1420-22  |
|           |           | 25          | 601200      | AM-1420-25  |
|           |           | 28          | 601201      | AM-1420-28  |
|           |           | 15          | 19          | 10          |
| 15        | 601209    |             |             | AM-1519-15  |
| 16        | 601210    |             |             | AM-1519-16  |
| 20        | 601211    |             |             | AM-1519-20  |
| 25        | 601212    |             |             | AM-1519-25  |
| 32        | 601213    |             |             | AM-1519-32  |
| 15        | 21        | 10          | 601223      | AM-1521-10  |
|           |           | 15          | 601224      | AM-1521-15  |
|           |           | 16          | 601225      | AM-1521-16  |
|           |           | 20          | 601226      | AM-1521-20  |
|           |           | 21          | 601227      | AM-1521-21  |
|           |           | 25          | 601228      | AM-1521-25  |
|           |           | 30          | 601229      | AM-1521-30  |
|           |           | 32          | 601230      | AM-1521-32  |
|           |           | 16          | 20          | 12          |
| 16        | 601244    |             |             | AM-1620-16  |
| 20        | 601245    |             |             | AM-1620-20  |
| 25        | 601246    |             |             | AM-1620-25  |
| 28        | 601247    |             |             | AM-1620-28  |
| 30        | 601248    |             |             | AM-1620-30  |
| 32        | 601249    |             |             | AM-1620-32  |
| 16        | 22        | 16          | 601252      | AM-1622-16  |
|           |           | 20          | 601253      | AM-1622-20  |
|           |           | 22          | 601254      | AM-1622-22  |
|           |           | 25          | 601255      | AM-1622-25  |
|           |           | 32          | 601257      | AM-1622-32  |
| 17        | 22        | 17          | 601262      | AM-1722-17  |
| 18        | 22        | 12          | 601264      | AM-1822-12  |
|           |           | 18          | 601265      | AM-1822-18  |
|           |           | 22          | 601266      | AM-1822-22  |
|           |           | 28          | 601267      | AM-1822-28  |
|           |           | 36          | 601269      | AM-1822-36  |
| 18        | 24        | 12          | 601271      | AM-1824-12  |
|           |           | 17          | 601272      | AM-1824-17  |
|           |           | 18          | 601273      | AM-1824-18  |
|           |           | 22          | 601274      | AM-1824-22  |
|           |           | 24          | 601275      | AM-1824-24  |
|           |           | 25          | 601276      | AM-1824-25  |
|           |           | 28          | 601277      | AM-1824-28  |
|           |           | 30          | 601278      | AM-1824-30  |
|           |           | 36          | 601279      | AM-1824-36  |

| I.D. (mm) | I.D. (mm) | Length (mm) | Item Number | Part Number |
|-----------|-----------|-------------|-------------|-------------|
| 18        | 25        | 22          | 601284      | AM-1825-22  |
|           |           | 28          | 601285      | AM-1825-28  |
|           |           | 36          | 601287      | AM-1825-36  |
| 20        | 23        | 24          | 601291      | AM-2023-24  |
| 20        | 24        | 16          | 601292      | AM-2024-16  |
|           |           | 20          | 601293      | AM-2024-20  |
|           |           | 24          | 601294      | AM-2024-24  |
|           |           | 25          | 601295      | AM-2024-25  |
|           |           | 27          | 601296      | AM-2024-27  |
|           |           | 30          | 601297      | AM-2024-30  |
| 20        | 25        | 32          | 601298      | AM-2024-32  |
|           |           | 15          | 601299      | AM-2025-15  |
|           |           | 16          | 601300      | AM-2025-16  |
|           |           | 20          | 601301      | AM-2025-20  |
|           |           | 22          | 601302      | AM-2025-22  |
|           |           | 25          | 601303      | AM-2025-25  |
| 20        | 26        | 28          | 601304      | AM-2025-28  |
|           |           | 30          | 601305      | AM-2025-30  |
|           |           | 32          | 601306      | AM-2025-32  |
|           |           | 15          | 601310      | AM-2026-15  |
|           |           | 16          | 601311      | AM-2026-16  |
|           |           | 20          | 601312      | AM-2026-20  |
| 20        | 27        | 25          | 601313      | AM-2026-25  |
|           |           | 32          | 601316      | AM-2026-32  |
|           |           | 16          | 601318      | AM-2027-16  |
|           |           | 20          | 601319      | AM-2027-20  |
| 20        | 28        | 25          | 601320      | AM-2027-25  |
|           |           | 32          | 601321      | AM-2027-32  |
|           |           | 16          | 601322      | AM-2028-16  |
|           |           | 20          | 601323      | AM-2028-20  |
| 20        | 28        | 25          | 601324      | AM-2028-25  |
|           |           | 28          | 601325      | AM-2028-28  |
|           |           | 30          | 601326      | AM-2028-30  |
|           |           | 32          | 601327      | AM-2028-32  |
|           |           | 15          | 601338      | AM-2227-15  |
|           |           | 18          | 601340      | AM-2227-18  |
| 22        | 27        | 20          | 601341      | AM-2227-20  |
|           |           | 22          | 601342      | AM-2227-22  |
|           |           | 25          | 601343      | AM-2227-25  |
|           |           | 28          | 601344      | AM-2227-28  |
|           |           | 36          | 601345      | AM-2227-36  |
|           |           | 18          | 601346      | AM-2228-18  |
|           |           | 20          | 601347      | AM-2228-20  |
| 22        | 28        | 22          | 601348      | AM-2228-22  |
|           |           | 28          | 601349      | AM-2228-28  |
|           |           | 30          | 601350      | AM-2228-30  |
|           |           | 36          | 601351      | AM-2228-36  |
|           |           | 18          | 601353      | AM-2229-18  |
| 22        | 29        | 22          | 601355      | AM-2229-22  |
|           |           | 28          | 601356      | AM-2229-28  |
|           |           | 36          | 601357      | AM-2229-36  |
|           |           | 20          | 601364      | AM-2530-20  |
| 25        | 30        | 25          | 601365      | AM-2530-25  |
|           |           | 28          | 601366      | AM-2530-28  |
|           |           | 30          | 601367      | AM-2530-30  |
|           |           | 32          | 601368      | AM-2530-32  |
|           |           | 35          | 601369      | AM-2530-35  |
|           |           | 40          | 601370      | AM-2530-40  |
|           |           | 45          | 601371      | AM-2530-45  |
|           |           | 50          | 601372      | AM-2530-50  |

\*Other sizes, tolerances, lubricants and materials are available on special orders.



| I.D.<br>( mm ) | O.D.<br>( mm ) | Length<br>( mm ) | Item<br>Number | Part<br>Number |
|----------------|----------------|------------------|----------------|----------------|
| 25             | 32             | 20               | 601373         | AM-2532-20     |
|                |                | 25               | 601374         | AM-2532-25     |
|                |                | 30               | 601375         | AM-2532-30     |
|                |                | 32               | 601376         | AM-2532-32     |
|                |                | 35               | 601377         | AM-2532-35     |
|                |                | 40               | 601378         | AM-2532-40     |
| 28             | 32             | 22               | 601390         | AM-2832-22     |
|                |                | 25               | 601391         | AM-2832-25     |
|                |                | 28               | 601392         | AM-2832-28     |
|                |                | 30               | 601393         | AM-2832-30     |
|                |                | 36               | 601394         | AM-2832-36     |
|                |                | 45               | 601395         | AM-2832-45     |
| 28             | 33             | 22               | 601396         | AM-2833-22     |
|                |                | 28               | 601397         | AM-2833-28     |
|                |                | 36               | 601398         | AM-2833-36     |
|                |                | 45               | 601399         | AM-2833-45     |
| 28             | 36             | 22               | 601401         | AM-2836-22     |
|                |                | 28               | 601402         | AM-2836-28     |
|                |                | 36               | 601403         | AM-2836-36     |
|                |                | 45               | 601404         | AM-2836-45     |
| 30             | 35             | 15               | 601408         | AM-3035-15     |
|                |                | 20               | 601409         | AM-3035-20     |
|                |                | 25               | 601410         | AM-3035-25     |
|                |                | 30               | 601411         | AM-3035-30     |
| 30             | 38             | 15               | 601415         | AM-3038-15     |
|                |                | 20               | 601416         | AM-3038-20     |
|                |                | 24               | 601417         | AM-3038-24     |
|                |                | 25               | 601418         | AM-3038-25     |
|                |                | 30               | 601419         | AM-3038-30     |
|                |                | 38               | 601420         | AM-3038-38     |
| 32             | 38             | 20               | 601434         | AM-3238-20     |
|                |                | 25               | 601435         | AM-3238-25     |
|                |                | 28               | 601436         | AM-3238-28     |
|                |                | 32               | 601437         | AM-3238-32     |
|                |                | 40               | 601438         | AM-3238-40     |
|                |                | 50               | 601439         | AM-3238-50     |
| 32             | 40             | 20               | 601440         | AM-3240-20     |
|                |                | 25               | 601441         | AM-3240-25     |
|                |                | 32               | 601442         | AM-3240-32     |
|                |                | 40               | 601443         | AM-3240-40     |
|                |                | 50               | 601444         | AM-3240-50     |
|                |                | 35               | 44             | 22             |
| 28             | 601459         |                  |                | AM-3544-28     |
| 35             | 601460         |                  |                | AM-3544-35     |
| 35             | 45             |                  |                | 25             |
|                |                | 35               | 601462         | AM-3545-35     |
|                |                | 40               | 601463         | AM-3545-40     |
|                |                | 45               | 601464         | AM-3545-45     |
|                |                | 50               | 601465         | AM-3545-50     |
| 36             | 42             | 22               | 601468         | AM-3642-22     |
|                |                | 28               | 601469         | AM-3642-28     |
|                |                | 36               | 601470         | AM-3642-36     |
|                |                | 45               | 601471         | AM-3642-45     |
|                |                | 36               | 45             | 22             |
| 28             | 601473         |                  |                | AM-3645-28     |
| 36             | 601474         |                  |                | AM-3645-36     |
| 45             | 601475         |                  |                | AM-3645-45     |
| 38             | 44             |                  |                | 25             |
|                |                | 35               | 601478         | AM-3844-35     |
|                |                | 45               | 601479         | AM-3844-45     |
|                |                | 40               | 46             | 25             |
| 30             | 601484         |                  |                | AM-4046-30     |
| 32             | 601485         |                  |                | AM-4046-32     |
| 40             | 601486         |                  |                | AM-4046-40     |
| 50             | 601487         |                  |                | AM-4046-50     |
| 40             | 50             | 25               | 601488         | AM-4050-25     |
|                |                | 30               | 601489         | AM-4050-30     |
|                |                | 32               | 601490         | AM-4050-32     |

| I.D.<br>( mm ) | O.D.<br>( mm ) | Length<br>( mm ) | Item<br>Number | Part<br>Number |        |            |
|----------------|----------------|------------------|----------------|----------------|--------|------------|
| 40             | 50             | 35               | 601491         | AM-4050-35     |        |            |
|                |                | 40               | 601492         | AM-4050-40     |        |            |
|                |                | 50               | 601493         | AM-4050-50     |        |            |
|                |                | 60               | 601494         | AM-4050-60     |        |            |
|                |                | 80               | 601495         | AM-4050-80     |        |            |
|                |                | 45               | 51             | 28             | 601497 | AM-4551-28 |
| 35             | 601498         |                  |                | AM-4551-35     |        |            |
| 36             | 601499         |                  |                | AM-4551-36     |        |            |
| 45             | 601500         |                  |                | AM-4551-45     |        |            |
| 55             | 601501         |                  |                | AM-4551-55     |        |            |
| 56             | 601502         |                  |                | AM-4551-56     |        |            |
| 45             | 55             |                  |                | 35             | 601504 | AM-4555-35 |
|                |                | 40               | 601505         | AM-4555-40     |        |            |
|                |                | 45               | 601506         | AM-4555-45     |        |            |
|                |                | 50               | 601507         | AM-4555-50     |        |            |
|                |                | 55               | 601508         | AM-4555-55     |        |            |
|                |                | 60               | 601509         | AM-4555-60     |        |            |
|                |                | 65               | 601510         | AM-4555-65     |        |            |
| 45             | 56             | 28               | 601512         | AM-4556-28     |        |            |
|                |                | 36               | 601513         | AM-4556-36     |        |            |
|                |                | 45               | 601514         | AM-4556-45     |        |            |
|                |                | 56               | 601515         | AM-4556-56     |        |            |
| 50             | 56             | 32               | 601518         | AM-5056-32     |        |            |
|                |                | 40               | 601519         | AM-5056-40     |        |            |
|                |                | 50               | 601520         | AM-5056-50     |        |            |
|                |                | 63               | 601522         | AM-5056-63     |        |            |
| 50             | 60             | 32               | 601523         | AM-5060-32     |        |            |
|                |                | 35               | 601524         | AM-5060-35     |        |            |
|                |                | 40               | 601525         | AM-5060-40     |        |            |
|                |                | 50               | 601526         | AM-5060-50     |        |            |
|                |                | 60               | 601527         | AM-5060-60     |        |            |
|                |                | 63               | 601528         | AM-5060-63     |        |            |
|                |                | 55               | 65             | 40             | 601533 | AM-5565-40 |
|                |                |                  |                | 55             | 601534 | AM-5565-55 |
| 60             | 601535         |                  |                | AM-5565-60     |        |            |
| 65             | 601536         |                  |                | AM-5565-65     |        |            |
| 70             | 601537         |                  |                | AM-5565-70     |        |            |
| 60             | 70             | 50               | 601543         | AM-6070-50     |        |            |
|                |                | 60               | 601544         | AM-6070-60     |        |            |
|                |                | 90               | 601545         | AM-6070-90     |        |            |
|                |                | 120              | 601546         | AM-6070-120    |        |            |
|                |                | 60               | 72             | 50             | 601547 | AM-6072-50 |
| 60             | 601548         |                  |                | AM-6072-60     |        |            |
| 63             | 601549         |                  |                | AM-6072-63     |        |            |
| 70             | 601550         |                  |                | AM-6072-70     |        |            |
| 60             | 80             |                  |                | 90             | 601553 | AM-6080-90 |
|                |                | 120              | 601554         | AM-6080-120    |        |            |
|                |                | 63               | 70             | 40             | 601556 | AM-6370-40 |
| 50             | 601557         |                  |                | AM-6370-50     |        |            |
| 70             | 80             | 60               | 601564         | AM-7080-60     |        |            |
|                |                | 90               | 601565         | AM-7080-90     |        |            |
|                |                | 120              | 601566         | AM-7080-120    |        |            |
| 80             | 100            | 120              | 601583         | AM-80100-120   |        |            |
| 100            | 120            | 80               | 601590         | AM-100120-80   |        |            |
|                |                | 120              | 601591         | AM-100120-120  |        |            |
| 110            | 125            | 120              | 601594         | AM-110125-120  |        |            |
| 125            | 150            | 120              | 601596         | AM-125150-120  |        |            |

\*Other sizes, tolerances, lubricants and materials are available on special orders.





| I.D.<br>(mm) | O.D.<br>(mm) | Length<br>(mm) | Flange<br>O.D.<br>(mm) | Flange<br>Thick<br>(mm) | Item<br>Number | Part<br>Number |
|--------------|--------------|----------------|------------------------|-------------------------|----------------|----------------|
| 3            | 6            | 4              | 9                      | 1.5                     | 602003         | FM-306-4       |
|              |              | 6              |                        |                         | 602004         | FM-306-6       |
|              |              | 10             |                        |                         | 602005         | FM-306-10      |
| 4            | 7            | 6              | 12                     | 2                       | 602008         | FM-407-6       |
|              |              | 10             |                        |                         | 602009         | FM-407-10      |
| 4            | 8            | 4              | 12                     | 2                       | 602012         | FM-408-4       |
|              |              | 6              |                        |                         | 602013         | FM-408-6       |
|              |              | 8              |                        |                         | 602014         | FM-408-8       |
|              |              | 12             |                        |                         | 602015         | FM-408-12      |
| 5            | 8            | 5              | 12                     | 2                       | 602017         | FM-508-5       |
|              |              | 6              |                        |                         | 602018         | FM-508-6       |
| 6            | 9            | 6              | 12                     | 1.5                     | 602026         | FM-609-6       |
|              |              | 10             |                        |                         | 602027         | FM-609-10      |
|              |              | 12             |                        |                         | 602028         | FM-609-12      |
| 6            | 9            | 5              | 14                     | 1.5                     | 602029         | FM-609-5-1     |
|              |              | 6              |                        |                         | 602030         | FM-609-6-1     |
|              |              | 10             |                        |                         | 602031         | FM-609-10-1    |
|              |              | 12             |                        |                         | 602032         | FM-609-12-1    |
| 6            | 10           | 4              | 14                     | 2                       | 602035         | FM-610-4       |
|              |              | 6              |                        |                         | 602036         | FM-610-6       |
|              |              | 10             |                        |                         | 602037         | FM-610-10      |
|              |              | 14             |                        |                         | 602038         | FM-610-14      |
|              |              | 16             |                        |                         | 602039         | FM-610-16      |
| 8            | 11           | 6              | 12                     | 1.5                     | 602045         | FM-811-6       |
|              |              | 10             |                        |                         | 602046         | FM-811-10      |
| 8            | 11           | 6              | 14                     | 1.5                     | 602048         | FM-811-6-1     |
|              |              | 10             |                        |                         | 602049         | FM-811-10-1    |
|              |              | 12             |                        |                         | 602050         | FM-811-12-1    |
| 8            | 12           | 6              | 16                     | 2                       | 602051         | FM-812-6       |
|              |              | 8              |                        |                         | 602052         | FM-812-8       |
|              |              | 12             |                        |                         | 602053         | FM-812-12      |
|              |              | 14             |                        |                         | 602054         | FM-812-14      |
|              |              | 16             |                        |                         | 602055         | FM-812-16      |
| 9            | 14           | 6              | 19                     | 2.5                     | 602062         | FM-914-6       |
|              |              | 10             |                        |                         | 602063         | FM-914-10      |
|              |              | 14             |                        |                         | 602064         | FM-914-14      |
| 10           | 13           | 6              | 16                     | 1.5                     | 602067         | FM-1013-6      |
|              |              | 8              |                        |                         | 602068         | FM-1013-8      |
|              |              | 10             |                        |                         | 602069         | FM-1013-10     |
|              |              | 12             |                        |                         | 602070         | FM-1013-12     |
|              |              | 16             |                        |                         | 602071         | FM-1013-16     |
|              |              | 20             |                        |                         | 602072         | FM-1013-20     |
| 10           | 15           | 10             | 20                     | 2.5                     | 602078         | FM-1015-10     |
|              |              | 16             |                        |                         | 602079         | FM-1015-16     |
|              |              | 20             |                        |                         | 602080         | FM-1015-20     |

| I.D.<br>(mm) | O.D.<br>(mm) | Length<br>(mm) | Flange<br>O.D.<br>(mm) | Flange<br>Thick<br>(mm) | Item<br>Number | Part<br>Number |
|--------------|--------------|----------------|------------------------|-------------------------|----------------|----------------|
| 10           | 16           | 8              | 20                     | 3                       | 602082         | FM-1016-8      |
|              |              | 10             |                        |                         | 602083         | FM-1016-10     |
|              |              | 16             |                        |                         | 602084         | FM-1016-16     |
| 10           | 16           | 8              | 22                     | 3                       | 602087         | FM-1016-8-1    |
|              |              | 10             |                        |                         | 602088         | FM-1016-10-1   |
|              |              | 16             |                        |                         | 602090         | FM-1016-16-1   |
| 12           | 15           | 7              | 18                     | 1.5                     | 602092         | FM-1215-7      |
|              |              | 12             |                        |                         | 602093         | FM-1215-12     |
|              |              | 16             |                        |                         | 602094         | FM-1215-16     |
|              |              | 20             |                        |                         | 602095         | FM-1215-20     |
| 12           | 16           | 12             | 20                     | 2                       | 602098         | FM-1216-12     |
|              |              | 16             |                        |                         | 602099         | FM-1216-16     |
|              |              | 25             |                        |                         | 602100         | FM-1216-25     |
| 12           | 17           | 12             | 22                     | 2.5                     | 602102         | FM-1217-12     |
|              |              | 16             |                        |                         | 602103         | FM-1217-16     |
|              |              | 20             |                        |                         | 602104         | FM-1217-20     |
|              |              | 25             |                        |                         | 602105         | FM-1217-25     |
| 12           | 18           | 8              | 24                     | 3                       | 602111         | FM-1218-8      |
|              |              | 10             |                        |                         | 602112         | FM-1218-10     |
|              |              | 12             |                        |                         | 602113         | FM-1218-12     |
|              |              | 16             |                        |                         | 602114         | FM-1218-16     |
|              |              | 20             |                        |                         | 602115         | FM-1218-20     |
| 14           | 18           | 12             | 22                     | 2                       | 602119         | FM-1418-12     |
|              |              | 14             |                        |                         | 602120         | FM-1418-14     |
|              |              | 18             |                        |                         | 602121         | FM-1418-18     |
|              |              | 20             |                        |                         | 602122         | FM-1418-20     |
|              |              | 22             |                        |                         | 602123         | FM-1418-22     |
| 14           | 20           | 10             | 26                     | 3                       | 602128         | FM-1420-10     |
|              |              | 14             |                        |                         | 602129         | FM-1420-14     |
|              |              | 18             |                        |                         | 602130         | FM-1420-18     |
|              |              | 22             |                        |                         | 602132         | FM-1420-22     |
| 15           | 19           | 15             | 23                     | 2                       | 602135         | FM-1519-15     |
|              |              | 16             |                        |                         | 602136         | FM-1519-16     |
|              |              | 20             |                        |                         | 602137         | FM-1519-20     |
|              |              | 25             |                        |                         | 602138         | FM-1519-25     |
| 15           | 21           | 10             | 27                     | 3                       | 602142         | FM-1521-10     |
|              |              | 15             |                        |                         | 602143         | FM-1521-15     |
|              |              | 16             |                        |                         | 602144         | FM-1521-16     |
|              |              | 20             |                        |                         | 602145         | FM-1521-20     |
|              |              | 25             |                        |                         | 602146         | FM-1521-25     |
|              |              | 32             |                        |                         | 602147         | FM-1521-32     |
| 15           | 22           | 12             | 28                     | 3                       | 602148         | FM-1522-12     |
|              |              | 15             |                        |                         | 602149         | FM-1522-15     |
| 16           | 20           | 12             | 24                     | 2                       | 602154         | FM-1620-12     |

\*Other sizes, tolerances, lubricants and materials are available on special orders.



| I.D.<br>(mm) | O.D.<br>(mm) | Length<br>(mm) | Flange       |               | Item<br>Number | Part<br>Number |
|--------------|--------------|----------------|--------------|---------------|----------------|----------------|
|              |              |                | O.D.<br>(mm) | Thick<br>(mm) |                |                |
| 16           | 20           | 16             | 24           | 2             | 602155         | FM-1620-16     |
|              |              | 20             |              |               | 602156         | FM-1620-20     |
|              |              | 25             |              |               | 602157         | FM-1620-25     |
| 16           | 22           | 12             | 28           | 3             | 602158         | FM-1622-12     |
|              |              | 16             |              |               | 602159         | FM-1622-16     |
|              |              | 20             |              |               | 602160         | FM-1622-20     |
|              |              | 25             |              |               | 602161         | FM-1622-25     |
|              |              | 32             |              |               | 602162         | FM-1622-32     |
| 18           | 22           | 18             | 26           | 2             | 602169         | FM-1822-18     |
|              |              | 20             |              |               | 602170         | FM-1822-20     |
|              |              | 22             |              |               | 602171         | FM-1822-22     |
| 18           | 24           | 12             | 30           | 3             | 602175         | FM-1824-12     |
|              |              | 18             |              |               | 602176         | FM-1824-18     |
|              |              | 22             |              |               | 602177         | FM-1824-22     |
|              |              | 28             |              |               | 602178         | FM-1824-28     |
| 20           | 24           | 12             | 28           | 2             | 602187         | FM-2024-12     |
|              |              | 16             |              |               | 602188         | FM-2024-16     |
|              |              | 20             |              |               | 602189         | FM-2024-20     |
|              |              | 25             |              |               | 602190         | FM-2024-25     |
| 20           | 26           | 15             | 32           | 3             | 602193         | FM-2026-15     |
|              |              | 16             |              |               | 602194         | FM-2026-16     |
|              |              | 20             |              |               | 602195         | FM-2026-20     |
|              |              | 25             |              |               | 602196         | FM-2026-25     |
|              |              | 30             |              |               | 602197         | FM-2026-30     |
| 22           | 27           | 18             | 32           | 2.5           | 602206         | FM-2227-18     |
|              |              | 22             |              |               | 602207         | FM-2227-22     |
|              |              | 28             |              |               | 602208         | FM-2227-28     |
| 22           | 28           | 15             | 34           | 3             | 602209         | FM-2228-15     |
|              |              | 16             |              |               | 602210         | FM-2228-16     |
|              |              | 20             |              |               | 602211         | FM-2228-20     |
|              |              | 25             |              |               | 602212         | FM-2228-25     |
|              |              | 30             |              |               | 602213         | FM-2228-30     |
| 22           | 29           | 18             | 36           | 3.5           | 602214         | FM-2229-18     |
|              |              | 22             |              |               | 602215         | FM-2229-22     |
|              |              | 28             |              |               | 602216         | FM-2229-28     |
|              |              | 36             |              |               | 602217         | FM-2229-36     |
| 25           | 30           | 20             | 35           | 2.5           | 602222         | FM-2530-20     |
|              |              | 25             |              |               | 602223         | FM-2530-25     |
|              |              | 30             |              |               | 602224         | FM-2530-30     |
|              |              | 32             |              |               | 602225         | FM-2530-32     |
| 25           | 32           | 20             | 39           | 3.5           | 602228         | FM-2532-20     |
|              |              | 25             |              |               | 602229         | FM-2532-25     |
|              |              | 30             |              |               | 602230         | FM-2532-30     |
|              |              | 32             |              |               | 602231         | FM-2532-32     |

| I.D.<br>(mm) | O.D.<br>(mm) | Length<br>(mm) | Flange       |               | Item<br>Number | Part<br>Number |
|--------------|--------------|----------------|--------------|---------------|----------------|----------------|
|              |              |                | O.D.<br>(mm) | Thick<br>(mm) |                |                |
| 28           | 33           | 22             | 38           | 2.5           | 602242         | FM-2833-22     |
|              |              | 28             |              |               | 602243         | FM-2833-28     |
|              |              | 36             |              |               | 602244         | FM-2833-36     |
| 28           | 36           | 22             | 44           | 4             | 602245         | FM-2836-22     |
|              |              | 28             |              |               | 602246         | FM-2836-28     |
|              |              | 36             |              |               | 602247         | FM-2836-36     |
| 30           | 38           | 20             | 46           | 4             | 602256         | FM-3038-20     |
|              |              | 25             |              |               | 602257         | FM-3038-25     |
|              |              | 30             |              |               | 602258         | FM-3038-30     |
| 32           | 38           | 20             | 44           | 3             | 602264         | FM-3238-20     |
|              |              | 25             |              |               | 602265         | FM-3238-25     |
|              |              | 32             |              |               | 602266         | FM-3238-32     |
| 32           | 40           | 20             | 48           | 4             | 602269         | FM-3240-20     |
|              |              | 25             |              |               | 602270         | FM-3240-25     |
|              |              | 30             |              |               | 602271         | FM-3240-30     |
|              |              | 32             |              |               | 602272         | FM-3240-32     |
| 36           | 42           | 22             | 48           | 3             | 602279         | FM-3642-22     |
|              |              | 28             |              |               | 602280         | FM-3642-28     |
|              |              | 36             |              |               | 602281         | FM-3642-36     |
| 36           | 45           | 22             | 54           | 4.5           | 602282         | FM-3645-22     |
|              |              | 28             |              |               | 602283         | FM-3645-28     |
|              |              | 36             |              |               | 602284         | FM-3645-36     |
| 40           | 46           | 25             | 52           | 3             | 602285         | FM-4046-25     |
|              |              | 32             |              |               | 602286         | FM-4046-32     |
|              |              | 40             |              |               | 602287         | FM-4046-40     |
| 40           | 50           | 30             | 60           | 5             | 602288         | FM-4050-30     |
|              |              | 32             |              |               | 602289         | FM-4050-32     |
|              |              | 40             |              |               | 602290         | FM-4050-40     |
| 45           | 51           | 28             | 57           | 3             | 602296         | FM-4551-28     |
|              |              | 36             |              |               | 602297         | FM-4551-36     |
|              |              | 45             |              |               | 602298         | FM-4551-45     |
| 45           | 56           | 28             | 67           | 5.5           | 602304         | FM-4556-28     |
|              |              | 36             |              |               | 602305         | FM-4556-36     |
|              |              | 45             |              |               | 602306         | FM-4556-45     |
| 50           | 56           | 30             | 62           | 3             | 602307         | FM-5056-30     |
|              |              | 32             |              |               | 602308         | FM-5056-32     |
|              |              | 40             |              |               | 602309         | FM-5056-40     |
| 50           | 60           | 50             | 70           | 5             | 602310         | FM-5056-50     |
|              |              | 32             |              |               | 602311         | FM-5060-32     |
|              |              | 35             |              |               | 602312         | FM-5060-35     |
| 50           | 60           | 40             | 70           | 5             | 602313         | FM-5060-40     |
|              |              | 50             |              |               | 602314         | FM-5060-50     |
|              |              | 60             |              |               | 602319         | FM-6070-50     |
| 60           | 70           | 50             | 80           | 5             | 602320         | FM-6070-60     |
|              |              | 60             |              |               | 602320         | FM-6070-60     |

\*Other sizes, tolerances, lubricants and materials are available on special orders.

## Isostatic Century® Cast Bronze Bearings

### SPECIAL SIZES & ALLOYS

Our Cast Bearings are made to exacting dimensions and a full range of bronze bearing alloys is available to suit your requirements. Orders placed in quantities from one to thousands are handled economically and fast.

### Graphiting

Graphite lubrication on the ID face of the bearing will enable you to obtain long bearing life both at high operating temperatures, and in applications lacking a supplemental lubrication. Graphiting is accomplished by grooving the I.D. and then pressing Graphite into the cavities under extremely high pressure.

When using a Graphite lubrication bearing, an allowance of .001 " to .002" additional clearance is suggested. This extra clearance can be obtained by ordering the bearing with a larger I.D. or by reaming. These bearings should be lubricated prior to assembly.

## Oil and Grease Grooves



### SINGLE LOOP

Johnson A Boston Gear III  
 Bunting 1 Buckeye A  
 Randall A



### FIGURE EIGHT

Johnson B Boston Gear IV  
 Bunting 4 Buckeye D  
 Randall B

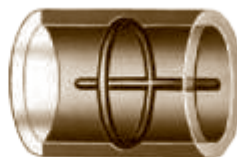

### ONE STRAIGHT and ONE CIRCULAR

Johnson C Boston Gear V  
 Bunting 3 Buckeye C



### DOUBLE LOOP

Johnson D Boston Gear VI  
 Bunting 2 Buckeye B  
 Randall D



### DOUBLE FIGURE EIGHT

Johnson E Boston Gear VII  
 Bunting 5 Buckeye E  
 Randall E



### R.H. and L.H. SPIRAL

Johnson F Boston Gear VIII  
 Bunting 11 Buckeye F  
 Randall F

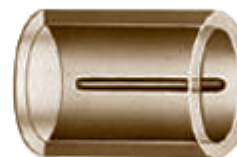

### STRAIGHT GROOVE

Johnson G  
 Randall G  
 Boston Gear I

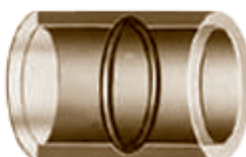

### CIRCULAR GROOVE

Johnson H  
 Randall H  
 Boston Gear II

### AIDS IN GROOVE SELECTION

Groove selection can be influenced by many things such as operating environment, type of lubricant, supplemental lubrication feed system, load etc.. The following information is intended as a guide. Consideration must be given to all factors.

Boundary lubrication is where none of the load is supported by the lubricant. Bearings which are only periodically lubricated will at some time operate under these conditions. Speeds which are 10 s.f.m. or less will cause boundary lubrication.

Suggested Grooving:  
 Double loop – Double figure 8

**Mixed film lubrication.** Load is partially supported by lubrication. Speeds from 10 to 25 s.f.m. will induce this condition. Most cast bronze bearing applications are in this category.

Suggested Grooving:  
 Straight. – Good for long bearings. It should be located in the unloaded area of the bearing. Circular – is used when the direction of load varies and a pressure fed lubricant system is present.

Straight Circular. – is applied in cases where the direction of the load varies and the lubricant is not pressure fed.

**Full film lubrication.** The load is separated from the bearing by a film of lubricant. A minimum speed of 25 s.f.m. will generally be needed.

Suggested Grooving:  
 The same types of grooving used in mixed film will work in the full film application.

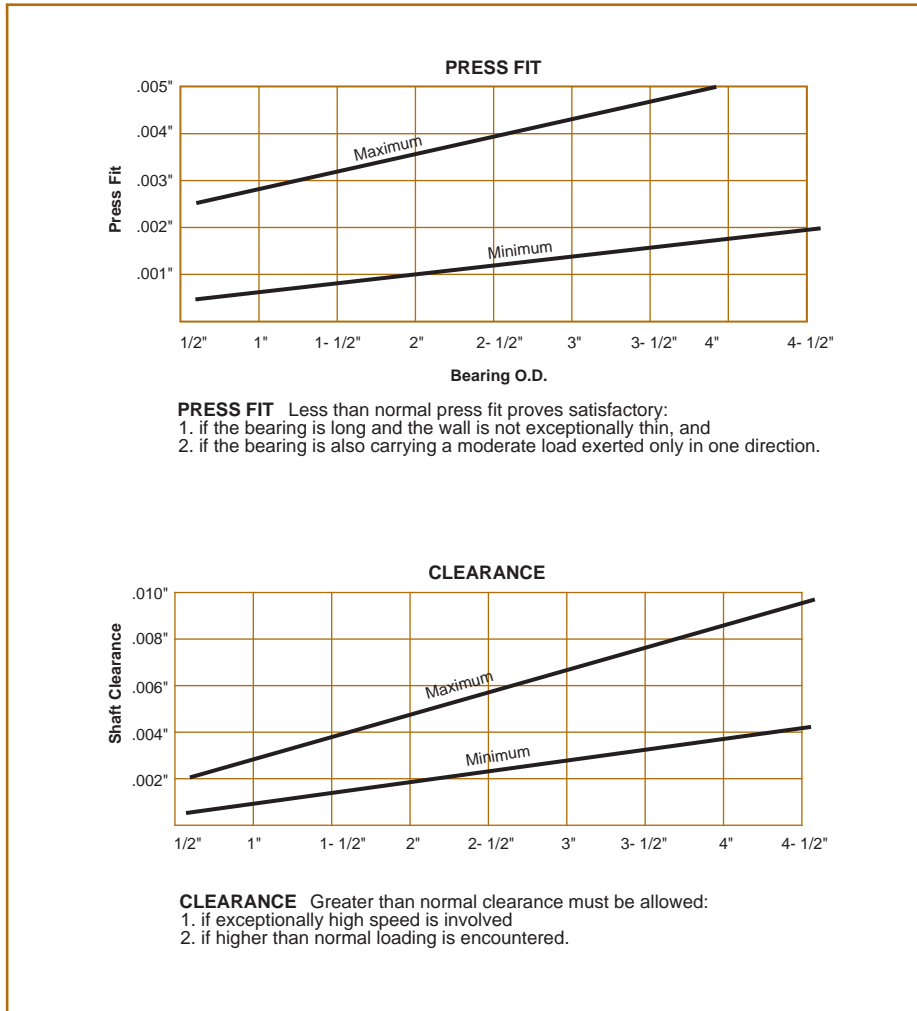

### CENTURY CAST BRONZE MATERIAL SPECIFICATIONS

| Chemical Composition                       | Tensile Strength | Yield Strength | Elongation in 2" | Brinell Hardness | Equivalent Specifications                          |
|--------------------------------------------|------------------|----------------|------------------|------------------|----------------------------------------------------|
| Copper 83%<br>Tin 7%<br>Lead 7%<br>Zinc 3% | 35000 P.S.I.     | 20000 P.S.I.   | 10%              | 72               | CDA 932<br>SAE 660<br>ASTM B505<br>ASTM B144-52-3B |

Typical Properties - not to be used for specification purposes

### TOLERANCES

|                 |                  |
|-----------------|------------------|
| I.D. 3" or less | ± .001"          |
| Over 3"         | ± .0015"         |
| O.D. 3" or less | + .002" to .003" |
| Over 3"         | + .003" to .005" |
| Length          | ± .005"          |
| Concentricity   | .003" T.I.R.     |



| I.D. | O.D.  | LENGTH | ITEM NO. | PART NO.   |
|------|-------|--------|----------|------------|
| 3/16 | 5/16  | 1/2    | 104004   | CB-0305-04 |
|      |       | 3/4    | 104005   | CB-0305-06 |
|      |       | 1      | 104006   | CB-0305-08 |
| 1/4  | 3/8   | 1/4    | 104007   | CB-0406-02 |
|      |       | 3/8    | 104008   | CB-0406-03 |
|      |       | 1/2    | 104009   | CB-0406-04 |
|      |       | 3/4    | 104010   | CB-0406-06 |
|      |       | 1      | 104011   | CB-0406-08 |
|      |       | 1-1/4  | 104012   | CB-0406-10 |
| 1/4  | 7/16  | 3/4    | 304010   | M46-6      |
|      |       | 3/4    | 104013   | CB-0407-06 |
|      |       | 1      | 104014   | CB-0407-08 |
|      |       | 1-1/4  | 104015   | CB-0407-10 |
| 5/16 | 7/16  | 3/8    | 104016   | CB-0507-03 |
|      |       | 1/2    | 104017   | CB-0507-04 |
|      |       | 3/4    | 104018   | CB-0507-06 |
|      |       | 1      | 104019   | CB-0507-08 |
|      |       | 1-1/4  | 104020   | CB-0507-10 |
| 5/16 | 1/2   | 3/4    | 104021   | CB-0508-06 |
|      |       | 1      | 104022   | CB-0508-08 |
|      |       | 1-1/4  | 104023   | CB-0508-10 |
| 3/8  | 1/2   | 3/8    | 104024   | CB-0608-03 |
|      |       | 1/2    | 104025   | CB-0608-04 |
|      |       | 3/4    | 104026   | CB-0608-06 |
|      |       | 1      | 104027   | CB-0608-08 |
|      |       | 1-1/4  | 104028   | CB-0608-10 |
|      |       | 1-1/2  | 104029   | CB-0608-12 |
| 3/8  | 9/16  | 3/4    | 104030   | CB-0609-06 |
|      |       | 1      | 104031   | CB-0609-08 |
|      |       | 1-1/4  | 104032   | CB-0609-10 |
| 3/8  | 5/8   | 3/4    | 104034   | CB-0610-06 |
|      |       | 1      | 104035   | CB-0610-08 |
|      |       | 1-1/4  | 104036   | CB-0610-10 |
|      |       | 1-1/2  | 104037   | CB-0610-12 |
|      |       | 1      | 304035   | M610-8     |
| 7/16 | 9/16  | 1      | 104038   | CB-0709-08 |
|      |       | 1-1/4  | 104039   | CB-0709-10 |
|      |       | 1-1/2  | 104040   | CB-0709-12 |
|      |       | 1-3/4  | 104042   | CB-0709-14 |
|      |       | 2      | 104043   | CB-0709-16 |
| 7/16 | 5/8   | 1      | 104044   | CB-0710-08 |
|      |       | 1-1/4  | 104045   | CB-0710-10 |
|      |       | 1-1/2  | 104046   | CB-0710-12 |
|      |       | 2      | 104047   | CB-0710-16 |
|      |       |        |          |            |
| 7/16 | 11/16 | 1-1/2  | 104048   | CB-0711-12 |
| 7/16 | 3/4   | 1      | 104049   | CB-0712-08 |
|      |       | 1-1/4  | 104050   | CB-0712-10 |
|      |       | 1-1/2  | 104051   | CB-0712-12 |
| 7/16 | 13/16 | 1-1/2  | 104052   | CB-0713-12 |
| 1/2  | 5/8   | 1/2    | 104053   | CB-0810-04 |
|      |       | 5/8    | 104054   | CB-0810-05 |

| I.D. | O.D.  | LENGTH | ITEM NO. | PART NO.   |        |            |
|------|-------|--------|----------|------------|--------|------------|
| 1/2  | 5/8   | 3/4    | 104055   | CB-0810-06 |        |            |
|      |       | 7/8    | 104056   | CB-0810-07 |        |            |
|      |       | 1      | 104057   | CB-0810-08 |        |            |
|      |       | 1-1/4  | 104058   | CB-0810-10 |        |            |
|      |       | 1-3/8  | 104059   | CB-0810-11 |        |            |
|      |       | 1-1/2  | 104060   | CB-0810-12 |        |            |
|      |       | 1-3/4  | 104061   | CB-0810-14 |        |            |
|      |       | 2      | 104062   | CB-0810-16 |        |            |
|      |       | 2-1/4  | 104063   | CB-0810-18 |        |            |
|      |       |        |          |            |        |            |
|      |       | 1/2    | 11/16    | 3/4        | 104064 | CB-0811-06 |
|      |       | 1      | 104065   | CB-0811-08 |        |            |
|      |       | 1-1/4  | 104066   | CB-0811-10 |        |            |
|      |       | 1-1/2  | 104067   | CB-0811-12 |        |            |
|      |       | 1-3/4  | 104068   | CB-0811-14 |        |            |
|      |       | 2      | 104069   | CB-0811-16 |        |            |
|      |       | 2-1/4  | 104070   | CB-0811-18 |        |            |
|      |       | 2-1/2  | 104071   | CB-0811-20 |        |            |
| 1/2  | 3/4   | 3/4    | 104073   | CB-0812-06 |        |            |
|      |       | 1      | 104074   | CB-0812-08 |        |            |
|      |       | 1-1/4  | 104075   | CB-0812-10 |        |            |
|      |       | 1-1/2  | 104076   | CB-0812-12 |        |            |
|      |       | 1-3/4  | 104078   | CB-0812-14 |        |            |
|      |       | 2      | 104079   | CB-0812-16 |        |            |
|      |       | 2-1/4  | 104080   | CB-0812-18 |        |            |
|      |       | 2-1/2  | 104081   | CB-0812-20 |        |            |
|      |       | 2-3/4  | 104082   | CB-0812-22 |        |            |
|      |       | 1      | 304074   | M812-8     |        |            |
|      |       |        |          |            |        |            |
| 1/2  | 13/16 | 1      | 104083   | CB-0813-08 |        |            |
|      |       | 1-1/2  | 104084   | CB-0813-12 |        |            |
|      |       | 2-1/4  | 104085   | CB-0813-18 |        |            |
| 1/2  | 7/8   | 1      | 104086   | CB-0814-08 |        |            |
|      |       | 1-1/4  | 104087   | CB-0814-10 |        |            |
|      |       | 1-1/2  | 104088   | CB-0814-12 |        |            |
|      |       | 1-3/4  | 104089   | CB-0814-14 |        |            |
|      |       | 2      | 104090   | CB-0814-16 |        |            |
|      |       |        |          |            |        |            |
| 1/2  | 1     | 1      | 104091   | CB-0816-08 |        |            |
|      |       | 1-1/2  | 104092   | CB-0816-12 |        |            |
|      |       | 2      | 104093   | CB-0816-16 |        |            |
|      |       | 2-1/4  | 104094   | CB-0816-18 |        |            |
| 9/16 | 11/16 | 1      | 104095   | CB-0911-08 |        |            |
|      |       | 1-1/4  | 104096   | CB-0911-10 |        |            |
|      |       | 1-1/2  | 104097   | CB-0911-12 |        |            |
|      |       | 1-3/4  | 104099   | CB-0911-14 |        |            |
|      |       | 2      | 104100   | CB-0911-16 |        |            |
|      |       | 2-1/4  | 104101   | CB-0911-18 |        |            |
|      |       | 2-1/2  | 104102   | CB-0911-20 |        |            |
| 9/16 | 3/4   | 1      | 104103   | CB-0912-08 |        |            |
|      |       | 1-1/4  | 104104   | CB-0912-10 |        |            |
|      |       | 1-1/2  | 104105   | CB-0912-12 |        |            |
|      |       | 1-3/4  | 104107   | CB-0912-14 |        |            |
|      |       | 2      | 104108   | CB-0912-16 |        |            |
|      |       | 2-1/4  | 104110   | CB-0912-18 |        |            |
|      |       |        |          |            |        |            |

| I.D. | O.D.  | LENGTH | ITEM NO. | PART NO.   |  |  |
|------|-------|--------|----------|------------|--|--|
| 9/16 | 3/4   | 2-1/2  | 104111   | CB-0912-20 |  |  |
| 9/16 | 13/16 | 1      | 104112   | CB-0913-08 |  |  |
|      |       | 1-1/4  | 104113   | CB-0913-10 |  |  |
|      |       | 1-1/2  | 104114   | CB-0913-12 |  |  |
|      |       | 1-3/4  | 104115   | CB-0913-14 |  |  |
|      |       | 2      | 104116   | CB-0913-16 |  |  |
|      |       | 2-1/2  | 104118   | CB-0913-20 |  |  |
| 9/16 | 7/8   | 1      | 104119   | CB-0914-08 |  |  |
|      |       | 1-1/2  | 104120   | CB-0914-12 |  |  |
|      |       | 2      | 104121   | CB-0914-16 |  |  |
| 5/8  | 3/4   | 1/2    | 104124   | CB-1012-04 |  |  |
|      |       | 3/4    | 104125   | CB-1012-06 |  |  |
|      |       | 1      | 104126   | CB-1012-08 |  |  |
|      |       | 1-1/8  | 104127   | CB-1012-09 |  |  |
|      |       | 1-1/4  | 104128   | CB-1012-10 |  |  |
|      |       | 1-1/2  | 104129   | CB-1012-11 |  |  |
|      |       | 1-3/4  | 104131   | CB-1012-14 |  |  |
|      |       | 2      | 104133   | CB-1012-16 |  |  |
|      |       | 2-1/4  | 104134   | CB-1012-18 |  |  |
|      |       | 2-1/2  | 104135   | CB-1012-20 |  |  |
|      |       | 3      | 104136   | CB-1012-24 |  |  |
|      |       | 1      | 304126   | M1012-8    |  |  |
| 5/8  | 13/16 | 1      | 104137   | CB-1013-08 |  |  |
|      |       | 1-1/4  | 104138   | CB-1013-10 |  |  |
|      |       | 1-1/2  | 104140   | CB-1013-12 |  |  |
|      |       | 1-3/4  | 104141   | CB-1013-14 |  |  |
|      |       | 2      | 104143   | CB-1013-16 |  |  |
|      |       | 2-1/4  | 104144   | CB-1013-18 |  |  |
|      |       | 2-1/2  | 104145   | CB-1013-20 |  |  |
| 5/8  | 7/8   | 1/2    | 104148   | CB-1014-04 |  |  |
|      |       | 3/4    | 104149   | CB-1014-06 |  |  |
|      |       | 1      | 104150   | CB-1014-08 |  |  |
|      |       | 1-1/8  | 104151   | CB-1014-09 |  |  |
|      |       | 1-1/4  | 104153   | CB-1014-10 |  |  |
|      |       | 1-1/2  | 104155   | CB-1014-12 |  |  |
|      |       | 1-3/4  | 104156   | CB-1014-14 |  |  |
|      |       | 2      | 104159   | CB-1014-16 |  |  |
|      |       | 2-1/4  | 104160   | CB-1014-18 |  |  |
| 5/8  | 15/16 | 1      | 104165   | CB-1015-08 |  |  |
|      |       | 1-1/2  | 104166   | CB-1015-12 |  |  |
|      |       | 2      | 104167   | CB-1015-16 |  |  |
|      |       | 2-1/2  | 104168   | CB-1015-20 |  |  |
|      |       |        |          |            |  |  |
|      |       |        |          |            |  |  |
| 5/8  | 1     | 1      | 104169   | CB-1016-08 |  |  |
|      |       | 1-1/2  | 104170   | CB-1016-12 |  |  |
|      |       | 2      | 104171   | CB-1016-16 |  |  |
|      |       | 2-1/4  | 104172   | CB-1016-18 |  |  |
|      |       | 2-1/2  | 104173   | CB-1016-20 |  |  |
|      |       | 3      | 104174   | CB-1016-24 |  |  |
| 5/8  | 1-1/8 | 1-1/2  | 104175   | CB-1018-12 |  |  |
|      |       | 2      | 104176   | CB-1018-16 |  |  |

\*Other sizes, tolerances, lubricants and materials are available on special orders.





| I.D.  | O.D.  | LENGTH | ITEM NO. | PART NO.   | I.D.  | O.D.   | LENGTH | ITEM NO. | PART NO.   | I.D.  | O.D.   | LENGTH | ITEM NO. | PART NO.   |
|-------|-------|--------|----------|------------|-------|--------|--------|----------|------------|-------|--------|--------|----------|------------|
| 5/8   | 1-1/8 | 2-1/4  | 104177   | CB-1018-18 | 3/4   | 1      | 1-7/8  | 104235   | CB-1216-15 | 7/8   | 1-1/16 | 1-1/2  | 104306   | CB-1417-12 |
|       |       | 3      | 104178   | CB-1018-24 |       |        | 2      | 104237   | CB-1216-16 |       |        | 1-3/4  | 104307   | CB-1417-14 |
| 11/16 | 13/16 | 1      | 104179   | CB-1113-08 |       |        | 2-1/8  | 104238   | CB-1216-17 |       |        | 2      | 104308   | CB-1417-16 |
|       |       | 1-1/4  | 104180   | CB-1113-10 |       |        | 2-1/4  | 104239   | CB-1216-18 |       |        | 2-1/4  | 104309   | CB-1417-18 |
|       |       | 1-1/2  | 104181   | CB-1113-12 |       |        | 2-1/2  | 104241   | CB-1216-20 |       |        | 2-1/2  | 104310   | CB-1417-20 |
|       |       | 1-3/4  | 104182   | CB-1113-14 |       |        | 2-3/4  | 104242   | CB-1216-22 |       |        | 3      | 104312   | CB-1417-24 |
|       |       | 2      | 104183   | CB-1113-16 |       |        | 3      | 104243   | CB-1216-24 |       |        |        |          |            |
|       |       | 2-1/2  | 104185   | CB-1113-20 |       |        | 3-1/2  | 104244   | CB-1216-28 | 7/8   | 1-1/8  | 3/4    | 104313   | CB-1418-06 |
| 11/16 | 7/8   | 1      | 104186   | CB-1114-08 |       |        | 1      | 304229   | M1216-8    |       |        | 1      | 104314   | CB-1418-08 |
|       |       | 1-1/4  | 104187   | CB-1114-10 | 3/4   | 1-1/16 | 1      | 104245   | CB-1217-08 |       |        | 1-1/4  | 104315   | CB-1418-10 |
|       |       | 1-1/2  | 104188   | CB-1114-12 |       |        | 1-1/2  | 104246   | CB-1217-12 |       |        | 1-3/8  | 104316   | CB-1418-11 |
|       |       | 1-3/4  | 104189   | CB-1114-14 |       |        | 2      | 104247   | CB-1217-16 |       |        | 1-1/2  | 104317   | CB-1418-12 |
|       |       | 2      | 104190   | CB-1114-16 |       |        | 2-1/4  | 104248   | CB-1217-18 |       |        | 1-3/4  | 104318   | CB-1418-14 |
|       |       | 2-1/4  | 104191   | CB-1114-18 |       |        | 2-1/2  | 104249   | CB-1217-20 |       |        | 2      | 104320   | CB-1418-16 |
|       |       | 2-1/2  | 104192   | CB-1114-20 |       |        | 3      | 104250   | CB-1217-24 |       |        | 2-1/4  | 104322   | CB-1418-18 |
| 11/16 | 15/16 | 1      | 104193   | CB-1115-08 | 3/4   | 1-1/8  | 1      | 104251   | CB-1218-08 |       |        | 2-1/2  | 104323   | CB-1418-20 |
|       |       | 1-1/4  | 104194   | CB-1115-10 |       |        | 1-1/2  | 104252   | CB-1218-12 |       |        | 3      | 104324   | CB-1418-24 |
|       |       | 1-1/2  | 104195   | CB-1115-12 |       |        | 2      | 104253   | CB-1218-16 |       |        | 3-1/4  | 104325   | CB-1418-26 |
|       |       | 1-3/4  | 104196   | CB-1115-14 |       |        | 2-1/4  | 104254   | CB-1218-18 |       |        | 3-1/2  | 104326   | CB-1418-28 |
|       |       | 2      | 104197   | CB-1115-16 |       |        | 2-1/2  | 104255   | CB-1218-20 | 7/8   | 1-3/16 | 1      | 104327   | CB-1419-08 |
|       |       | 2-1/2  | 104199   | CB-1115-20 |       |        | 3      | 104256   | CB-1218-24 |       |        | 1-1/4  | 104328   | CB-1419-10 |
| 11/16 | 1     | 1-1/4  | 104201   | CB-1116-10 | 3/4   | 1-3/16 | 1-1/2  | 104258   | CB-1219-12 |       |        | 1-1/2  | 104329   | CB-1419-12 |
|       |       | 2-1/4  | 104204   | CB-1116-18 |       |        | 2      | 104259   | CB-1219-16 |       |        | 2      | 104330   | CB-1419-16 |
|       |       | 2-1/2  | 104205   | CB-1116-20 | 3/4   | 1-1/4  | 1-3/4  | 104263   | CB-1220-14 |       |        | 2-1/2  | 104331   | CB-1419-20 |
| 3/4   | 7/8   | 3/4    | 104207   | CB-1214-06 |       |        | 2      | 104264   | CB-1220-16 |       |        | 3      | 104333   | CB-1419-24 |
|       |       | 1      | 104208   | CB-1214-08 |       |        | 2-1/4  | 104265   | CB-1220-18 | 7/8   | 1-1/4  | 1-1/2  | 104334   | CB-1420-12 |
|       |       | 1-1/4  | 104209   | CB-1214-10 |       |        | 2-1/2  | 104266   | CB-1220-20 |       |        | 1-3/4  | 104335   | CB-1420-14 |
|       |       | 1-1/2  | 104210   | CB-1214-12 |       |        | 3      | 104267   | CB-1220-24 |       |        | 2      | 104336   | CB-1420-16 |
|       |       | 1-3/4  | 104211   | CB-1214-14 |       |        |        |          |            |       |        | 2-1/4  | 104337   | CB-1420-18 |
|       |       | 2      | 104212   | CB-1214-16 | 13/16 | 15/16  | 1      | 104268   | CB-1315-08 |       |        | 2-1/2  | 104338   | CB-1420-20 |
|       |       | 2-1/4  | 104213   | CB-1214-18 |       |        | 1-1/2  | 104271   | CB-1315-12 |       |        | 3      | 104339   | CB-1420-24 |
|       |       | 2-1/2  | 104214   | CB-1214-20 |       |        | 2      | 104272   | CB-1315-16 |       |        | 3-1/2  | 104340   | CB-1420-28 |
|       |       | 3/4    | 304207   | M1214-6    | 13/16 | 1      | 1-1/2  | 104274   | CB-1316-12 |       |        | 4      | 104341   | CB-1420-32 |
| 3/4   | 15/16 | 1      | 104215   | CB-1215-08 |       |        | 1-3/4  | 104275   | CB-1316-14 | 7/8   | 1-3/8  | 1-1/2  | 104344   | CB-1422-12 |
|       |       | 1-1/4  | 104217   | CB-1215-10 |       |        | 2      | 104276   | CB-1316-16 |       |        | 1-3/4  | 104345   | CB-1422-14 |
|       |       | 1-3/8  | 104218   | CB-1215-11 |       |        | 2-1/2  | 104277   | CB-1316-20 |       |        | 2      | 104346   | CB-1422-16 |
|       |       | 1-1/2  | 104219   | CB-1215-12 | 13/16 | 1-1/16 | 1-1/2  | 104279   | CB-1317-12 |       |        | 2-1/2  | 104347   | CB-1422-20 |
|       |       | 1-3/4  | 104220   | CB-1215-14 |       |        | 2      | 104280   | CB-1317-16 |       |        | 3      | 104348   | CB-1422-24 |
|       |       | 2      | 104221   | CB-1215-16 |       |        | 2-1/2  | 104281   | CB-1317-20 | 15/16 | 1-1/8  | 1-1/2  | 104351   | CB-1518-12 |
|       |       | 2-1/4  | 104222   | CB-1215-18 |       |        | 2-3/4  | 104282   | CB-1317-22 |       |        | 2      | 104352   | CB-1518-16 |
|       |       | 2-1/2  | 104223   | CB-1215-20 |       |        | 3      | 104283   | CB-1317-24 |       |        | 2-1/2  | 104354   | CB-1518-20 |
|       |       | 2-3/4  | 104224   | CB-1215-22 | 13/16 | 1-1/8  | 1-1/2  | 104284   | CB-1318-12 | 15/16 | 1-3/16 | 1-1/4  | 104355   | CB-1519-10 |
|       |       | 3      | 104225   | CB-1215-24 |       |        | 2      | 104285   | CB-1318-16 |       |        | 1-1/2  | 104357   | CB-1519-12 |
| 3/4   | 1     | 1/2    | 104226   | CB-1216-04 | 13/16 | 1-3/16 | 2-1/2  | 104287   | CB-1319-20 |       |        | 2      | 104358   | CB-1519-16 |
|       |       | 3/4    | 104227   | CB-1216-06 |       |        | 3      | 104288   | CB-1319-24 |       |        | 2-1/4  | 104359   | CB-1519-18 |
|       |       | 7/8    | 104228   | CB-1216-07 | 7/8   | 1      | 1      | 104296   | CB-1416-08 |       |        | 3      | 104361   | CB-1519-24 |
|       |       | 1      | 104229   | CB-1216-08 |       |        | 1-1/4  | 104297   | CB-1416-10 | 15/16 | 1-1/4  | 1      | 104362   | CB-1520-08 |
|       |       | 1-1/8  | 104230   | CB-1216-09 |       |        | 1-3/8  | 104298   | CB-1416-11 |       |        | 1-1/2  | 104363   | CB-1520-12 |
|       |       | 1-1/4  | 104231   | CB-1216-10 |       |        | 1-1/2  | 104299   | CB-1416-12 |       |        | 2      | 104364   | CB-1520-16 |
|       |       | 1-3/8  | 104232   | CB-1216-11 |       |        | 1-5/8  | 104300   | CB-1416-13 |       |        | 2-1/2  | 104366   | CB-1520-20 |
|       |       | 1-1/2  | 104233   | CB-1216-12 |       |        | 2      | 104301   | CB-1416-16 |       |        | 2-3/4  | 104367   | CB-1520-22 |
|       |       | 1-3/4  | 104234   | CB-1216-14 | 7/8   | 1-1/16 | 1      | 104303   | CB-1417-08 | 15/16 | 1-5/16 | 1-1/2  | 104368   | CB-1521-12 |
|       |       |        |          |            |       |        | 1-1/4  | 104304   | CB-1417-10 |       |        | 2      | 104370   | CB-1521-16 |
|       |       |        |          |            |       |        |        |          |            |       |        | 3      | 104372   | CB-1521-24 |

\*Other sizes, tolerances, lubricants and materials are available on special orders.



| I.D.  | O.D.   | LENGTH | ITEM NO. | PART NO.   |        |            |
|-------|--------|--------|----------|------------|--------|------------|
| 1     | 1-1/8  | 1      | 104373   | CB-1618-08 |        |            |
|       |        | 1-3/8  | 104374   | CB-1618-11 |        |            |
|       |        | 1-1/2  | 104375   | CB-1618-12 |        |            |
|       |        | 1-3/4  | 104376   | CB-1618-14 |        |            |
|       |        | 2      | 104377   | CB-1618-18 |        |            |
|       |        | 2-1/2  | 104378   | CB-1618-20 |        |            |
| 1     | 1-3/16 | 7/8    | 104379   | CB-1619-07 |        |            |
|       |        | 1      | 105031   | CB-1619-08 |        |            |
|       |        | 1-1/4  | 104380   | CB-1619-10 |        |            |
|       |        | 1-1/2  | 104381   | CB-1619-12 |        |            |
|       |        | 1-3/4  | 104383   | CB-1619-14 |        |            |
|       |        | 2      | 104384   | CB-1619-16 |        |            |
|       |        | 2-1/2  | 104386   | CB-1619-20 |        |            |
|       |        | 1      | 1-1/4    | 3/4        | 104387 | CB-1620-06 |
|       |        |        |          | 1          | 104388 | CB-1620-08 |
|       |        |        |          | 1-1/8      | 104389 | CB-1620-09 |
| 1-1/4 | 104390 |        |          | CB-1620-10 |        |            |
| 1-3/8 | 104391 |        |          | CB-1620-11 |        |            |
| 1-1/2 | 104392 |        |          | CB-1620-12 |        |            |
| 1-5/8 | 104393 |        |          | CB-1620-13 |        |            |
| 1-3/4 | 104394 |        |          | CB-1620-14 |        |            |
| 1-7/8 | 105032 |        |          | CB-1620-15 |        |            |
| 2     | 104395 |        |          | CB-1620-16 |        |            |
| 2-1/4 | 104397 |        |          | CB-1620-18 |        |            |
| 2-1/2 | 104398 |        |          | CB-1620-20 |        |            |
| 2-3/4 | 104399 |        |          | CB-1620-22 |        |            |
| 3     | 104400 |        |          | CB-1620-24 |        |            |
| 3-1/2 | 104401 |        |          | CB-1620-28 |        |            |
| 3-3/4 | 104402 |        |          | CB-1620-30 |        |            |
| 4     | 104403 |        |          | CB-1620-32 |        |            |
| 4-1/2 | 104404 |        |          | CB-1620-36 |        |            |
| 1     | 1-5/16 |        |          | 1-1/2      | 104405 | CB-1621-12 |
|       |        |        |          | 2          | 104406 | CB-1621-16 |
|       |        | 2-1/4  | 104407   | CB-1621-18 |        |            |
|       |        | 2-1/2  | 104408   | CB-1621-20 |        |            |
|       |        | 3      | 104409   | CB-1621-24 |        |            |
|       |        | 3-1/2  | 104410   | CB-1621-28 |        |            |
|       |        | 3-3/4  | 104411   | CB-1621-30 |        |            |
|       |        | 1      | 1-3/8    | 1          | 104412 | CB-1622-08 |
| 1-1/4 | 104413 |        |          | CB-1622-10 |        |            |
| 1-1/2 | 104414 |        |          | CB-1622-12 |        |            |
| 1-3/4 | 104415 |        |          | CB-1622-14 |        |            |
| 2     | 104416 |        |          | CB-1622-16 |        |            |
| 2-1/2 | 104417 |        |          | CB-1622-20 |        |            |
| 2-3/4 | 104418 |        |          | CB-1622-22 |        |            |
| 3     | 104419 |        |          | CB-1622-24 |        |            |
| 3-1/4 | 104420 |        |          | CB-1622-26 |        |            |
| 3-1/2 | 104421 |        |          | CB-1622-28 |        |            |
| 4     | 104422 |        |          | CB-1622-32 |        |            |
| 4-1/2 | 104423 |        |          | CB-1622-36 |        |            |
| 1     | 1-1/2  |        |          | 1-1/2      | 104424 | CB-1624-12 |
|       |        |        |          | 1-3/4      | 104425 | CB-1624-14 |
|       |        | 2      | 104426   | CB-1624-16 |        |            |
|       |        | 2-1/2  | 104427   | CB-1624-20 |        |            |

| I.D.   | O.D.   | LENGTH     | ITEM NO. | PART NO.   |        |            |
|--------|--------|------------|----------|------------|--------|------------|
| 1      | 1-1/2  | 3          | 104428   | CB-1624-24 |        |            |
|        |        | 4          | 104429   | CB-1624-32 |        |            |
| 1      | 1-5/8  | 2          | 104431   | CB-1626-16 |        |            |
|        |        | 2-1/2      | 104432   | CB-1626-20 |        |            |
|        |        | 3          | 104433   | CB-1626-24 |        |            |
|        |        | 3-1/2      | 104434   | CB-1626-28 |        |            |
|        |        | 3          | 304433   | M1626-24   |        |            |
|        |        | 1          | 1-3/4    | 6-1/2      | 104436 | CB-1628-52 |
| 1      | 2      | 3          | 104437   | CB-1632-24 |        |            |
|        |        | 6-1/2      | 104440   | CB-1632-52 |        |            |
| 1-1/16 | 1-5/16 | 1-1/2      | 104442   | CB-1721-12 |        |            |
|        |        | 2          | 104443   | CB-1721-16 |        |            |
|        |        | 2-1/2      | 104444   | CB-1721-20 |        |            |
|        |        | 3          | 104445   | CB-1721-24 |        |            |
|        |        | 3-1/2      | 104446   | CB-1721-28 |        |            |
|        |        | 1-1/16     | 1-3/8    | 1          | 104447 | CB-1722-08 |
| 1-1/16 | 1-7/16 | 2          | 104448   | CB-1722-16 |        |            |
|        |        | 2-1/2      | 104449   | CB-1722-20 |        |            |
| 1-1/16 | 1-7/16 | 2-1/2      | 104450   | CB-1723-20 |        |            |
|        |        | 3          | 104451   | CB-1723-24 |        |            |
|        |        | 4          | 104453   | CB-1723-32 |        |            |
|        |        | 1-1/8      | 1-1/4    | 1-1/2      | 104457 | CB-1820-12 |
| 1-1/8  | 1-1/4  | 1-3/4      | 104459   | CB-1820-14 |        |            |
|        |        | 2          | 104460   | CB-1820-16 |        |            |
| 1-1/8  | 1-5/16 | 2-1/4      | 104462   | CB-1821-18 |        |            |
|        |        | 2-1/2      | 104463   | CB-1821-20 |        |            |
| 1-1/8  | 1-3/8  | 1          | 104464   | CB-1822-08 |        |            |
|        |        | 1-1/4      | 104465   | CB-1822-10 |        |            |
|        |        | 1-1/2      | 104466   | CB-1822-12 |        |            |
|        |        | 1-3/4      | 104467   | CB-1822-14 |        |            |
|        |        | 2          | 104468   | CB-1822-16 |        |            |
|        |        | 2-1/4      | 104470   | CB-1822-18 |        |            |
|        |        | 2-1/2      | 104471   | CB-1822-20 |        |            |
|        |        | 3          | 104472   | CB-1822-24 |        |            |
|        |        | 3-1/4      | 104473   | CB-1822-26 |        |            |
|        |        | 3-1/2      | 104474   | CB-1822-28 |        |            |
| 4      | 104475 | CB-1822-32 |          |            |        |            |
| 1-1/8  | 1-7/16 | 1-1/2      | 104478   | CB-1823-12 |        |            |
|        |        | 2-1/2      | 104479   | CB-1823-20 |        |            |
|        |        | 3          | 104480   | CB-1823-24 |        |            |
|        |        | 3-1/2      | 104481   | CB-1823-28 |        |            |
|        |        | 1-1/8      | 1-1/2    | 1-1/2      | 104482 | CB-1824-12 |
|        |        | 2          | 104483   | CB-1824-16 |        |            |
| 1-1/8  | 1-1/2  | 2-1/2      | 104484   | CB-1824-20 |        |            |
|        |        | 3          | 104485   | CB-1824-24 |        |            |
|        |        | 3-1/2      | 104486   | CB-1824-28 |        |            |
|        |        | 4          | 104487   | CB-1824-32 |        |            |
|        |        | 1-1/8      | 1-5/8    | 1-3/4      | 104489 | CB-1826-14 |
|        |        | 2          | 104490   | CB-1826-16 |        |            |
|        |        | 2-1/2      | 104491   | CB-1826-20 |        |            |
|        |        | 3          | 104492   | CB-1826-24 |        |            |
| 1-1/8  | 1-5/8  | 3-1/2      | 104493   | CB-1826-28 |        |            |
|        |        | 4          | 104494   | CB-1826-32 |        |            |
|        |        | 4-1/2      | 104495   | CB-1826-36 |        |            |
|        |        | 1-1/8      | 1-7/8    | 6-1/2      | 104496 | CB-1830-52 |
| 1-1/8  | 2      | 3          | 104497   | CB-1832-24 |        |            |
|        |        | 5-1/2      | 104498   | CB-1832-44 |        |            |

| I.D.   | O.D.    | LENGTH     | ITEM NO. | PART NO.   |
|--------|---------|------------|----------|------------|
| 1-3/16 | 1-3/8   | 1-3/4      | 104499   | CB-1922-14 |
|        |         | 2          | 104500   | CB-1922-16 |
|        |         | 2-1/2      | 104501   | CB-1922-20 |
| 1-3/16 | 1-7/16  | 1-1/4      | 104502   | CB-1923-10 |
|        |         | 1-1/2      | 104503   | CB-1923-12 |
|        |         | 2          | 104504   | CB-1923-16 |
|        |         | 2-1/2      | 104505   | CB-1923-20 |
|        |         | 3          | 104507   | CB-1923-24 |
|        |         | 3-1/2      | 104508   | CB-1923-28 |
| 1-3/16 | 1-1/2   | 2          | 104509   | CB-1924-16 |
|        |         | 3          | 104510   | CB-1924-24 |
|        |         | 4          | 104511   | CB-1924-32 |
|        |         | 1-3/16     | 1-9/16   | 1-1/2      |
| 1-3/16 | 1-9/16  | 2-1/2      | 104513   | CB-1925-20 |
|        |         | 3          | 104514   | CB-1925-24 |
|        |         | 3-1/2      | 104515   | CB-1925-28 |
| 1-3/16 | 1-5/8   | 2          | 104516   | CB-1926-16 |
|        |         | 2-1/2      | 104517   | CB-1926-20 |
|        |         | 3          | 104518   | CB-1926-24 |
| 1-3/16 | 1-11/16 | 2          | 104519   | CB-1927-16 |
|        |         | 2-1/2      | 104520   | CB-1927-20 |
|        |         | 3          | 104521   | CB-1927-24 |
|        |         | 3-1/2      | 104522   | CB-1927-28 |
| 1-1/4  | 1-7/16  | 2          | 105033   | CB-2023-16 |
|        |         | 2-1/2      | 104526   | CB-2023-20 |
|        |         | 3          | 104527   | CB-2023-24 |
| 1-1/4  | 1-1/2   | 1          | 104528   | CB-2024-08 |
|        |         | 1-1/8      | 104529   | CB-2024-09 |
|        |         | 1-1/4      | 104530   | CB-2024-10 |
|        |         | 1-3/8      | 104531   | CB-2024-11 |
|        |         | 1-1/2      | 104532   | CB-2024-12 |
|        |         | 1-5/8      | 104533   | CB-2024-13 |
|        |         | 1-3/4      | 104534   | CB-2024-14 |
|        |         | 2          | 104536   | CB-2024-16 |
|        |         | 2-1/4      | 104538   | CB-2024-18 |
|        |         | 2-1/2      | 104539   | CB-2024-20 |
|        |         | 2-3/4      | 104540   | CB-2024-22 |
|        |         | 3          | 104541   | CB-2024-24 |
|        |         | 3-1/4      | 104542   | CB-2024-26 |
|        |         | 3-1/2      | 104543   | CB-2024-28 |
| 4      | 104545  | CB-2024-32 |          |            |
| 4-1/4  | 104546  | CB-2024-34 |          |            |
| 4-1/2  | 104547  | CB-2024-36 |          |            |
| 5      | 104548  | CB-2024-40 |          |            |
| 5-1/2  | 104549  | CB-2024-44 |          |            |
| 1-1/4  | 1-9/16  | 2          | 104550   | CB-2025-16 |
|        |         | 2-1/2      | 104552   | CB-2025-20 |
|        |         | 3          | 104554   | CB-2025-24 |
|        |         | 3-1/2      | 104555   | CB-2025-28 |
|        |         | 3-3/4      | 104556   | CB-2025-30 |
|        |         | 1-1/4      | 1-5/8    | 1-3/4      |
| 1-1/4  | 1-5/8   | 2          | 104559   | CB-2026-16 |
|        |         | 2-1/2      | 104560   | CB-2026-20 |

\*Other sizes, tolerances, lubricants and materials are available on special orders.



| I.D.   | O.D.    | LENGTH     | ITEM NO. | PART NO.   | I.D.   | O.D.       | LENGTH     | ITEM NO.   | PART NO.   | I.D.       | O.D.       | LENGTH     | ITEM NO.   | PART NO.   |        |            |
|--------|---------|------------|----------|------------|--------|------------|------------|------------|------------|------------|------------|------------|------------|------------|--------|------------|
| 1-1/4  | 1-5/8   | 3          | 104561   | CB-2026-24 | 1-3/8  | 1-5/8      | 3-1/4      | 104620     | CB-2226-26 | 1-1/2      | 1-3/4      | 1-1/2      | 104682     | CB-2428-12 |        |            |
|        |         | 3-1/4      | 104562   | CB-2026-26 |        |            | 3-1/2      | 104621     | CB-2226-28 |            |            | 1-3/4      | 104683     | CB-2428-14 |        |            |
|        |         | 3-1/2      | 104563   | CB-2026-28 |        |            | 4          | 104622     | CB-2226-32 |            |            | 2          | 104684     | CB-2428-16 |        |            |
|        |         | 4          | 104564   | CB-2026-32 |        |            | 4-1/2      | 104623     | CB-2226-36 |            |            | 2-1/4      | 104686     | CB-2428-18 |        |            |
|        |         | 4-1/2      | 104566   | CB-2026-36 |        |            | 1-3/8      | 1-11/16    | 3-1/2      |            |            | 104624     | CB-2227-28 | 2-1/2      | 104687 | CB-2428-20 |
|        |         | 4-3/4      | 104567   | CB-2026-38 |        |            | 1-3/8      | 1-3/4      | 2          |            |            | 104625     | CB-2228-16 | 3          | 104688 | CB-2428-24 |
| 1-1/4  | 1-11/16 | 2          | 104568   | CB-2027-16 | 2-1/4  |            | 104626     | CB-2228-18 | 3-1/2      | 104689     | CB-2428-28 |            |            |            |        |            |
|        |         | 2-1/2      | 104569   | CB-2027-20 | 2-1/2  |            | 104627     | CB-2228-20 | 4          | 104690     | CB-2428-32 |            |            |            |        |            |
|        |         | 3-1/4      | 104570   | CB-2027-26 | 3      |            | 104628     | CB-2228-24 | 4-1/2      | 104691     | CB-2428-36 |            |            |            |        |            |
|        |         | 3-1/2      | 104571   | CB-2027-28 | 3-1/2  |            | 104630     | CB-2228-28 | 5          | 104692     | CB-2428-40 |            |            |            |        |            |
|        |         | 4          | 104631   | CB-2228-32 | 5-1/2  |            | 104693     | CB-2428-44 |            |            |            |            |            |            |        |            |
| 1-1/4  | 1-3/4   | 1-1/4      | 105034   | CB-2028-10 | 1-3/8  | 1-7/8      | 3          | 104632     | CB-2230-24 | 1-1/2      | 1-13/16    | 3          | 104694     | CB-2429-24 |        |            |
|        |         | 1-3/4      | 104572   | CB-2028-14 |        |            | 3-1/2      | 104633     | CB-2230-28 | 1-1/2      | 1-7/8      | 1-1/2      | 104695     | CB-2430-12 |        |            |
|        |         | 2          | 104573   | CB-2028-16 |        |            | 4          | 104634     | CB-2230-32 | 2          | 104696     | CB-2430-16 |            |            |        |            |
|        |         | 2-1/4      | 104574   | CB-2028-18 | 4-1/2  | 104635     | CB-2230-36 | 2-1/2      | 104697     | CB-2430-20 |            |            |            |            |        |            |
|        |         | 2-1/2      | 104575   | CB-2028-20 | 1-3/8  | 2          | 3          | 104636     | CB-2232-24 | 2-3/4      | 104698     | CB-2430-22 |            |            |        |            |
|        |         | 2-3/4      | 104576   | CB-2028-22 |        |            | 4          | 104637     | CB-2232-32 | 3          | 104699     | CB-2430-24 |            |            |        |            |
|        |         | 3          | 104577   | CB-2028-24 | 1-3/8  | 2-1/8      | 6-1/2      | 104638     | CB-2234-52 | 3-1/2      | 104700     | CB-2430-28 |            |            |        |            |
|        |         | 3-1/2      | 104578   | CB-2028-28 |        |            | 1-7/16     | 1-5/8      | 1-3/4      | 104639     | CB-2326-14 | 4          | 104701     | CB-2430-32 |        |            |
|        |         | 3-3/4      | 104579   | CB-2028-30 | 2-3/4  | 104640     |            |            | CB-2326-22 | 4-1/2      | 104704     | CB-2430-36 |            |            |        |            |
|        |         | 4          | 104580   | CB-2028-32 | 3      | 104641     |            |            | CB-2326-24 | 5          | 104705     | CB-2430-40 |            |            |        |            |
|        |         | 5          | 104582   | CB-2028-40 | 1-7/16 | 1-11/16    | 2-1/2      | 104642     | CB-2327-20 | 5-1/2      | 104706     | CB-2430-44 |            |            |        |            |
|        |         |            |          | 2-1/2      | 104584 | CB-2030-20 | 3          | 104643     | CB-2327-24 | 1-1/2      | 2          | 2          | 105036     | CB-2432-16 |        |            |
|        |         | 3          | 104585   | CB-2030-24 | 3-1/2  | 104644     | CB-2327-28 | 2-1/2      | 104707     |            |            | CB-2432-20 |            |            |        |            |
|        |         | 4          | 104586   | CB-2030-32 | 4      | 104645     | CB-2327-32 | 3          | 104708     |            |            | CB-2432-24 |            |            |        |            |
| 1-1/4  | 2       | 3          | 104587   | CB-2032-24 | 4-1/4  | 104646     | CB-2327-34 | 3-1/2      | 104709     |            |            | CB-2432-28 |            |            |        |            |
|        |         | 4          | 104588   | CB-2032-32 | 1-7/16 | 1-3/4      | 2-1/4      | 104648     | CB-2328-18 |            |            | 4          | 104710     | CB-2432-32 |        |            |
|        |         | 6-1/2      | 104589   | CB-2032-52 |        |            | 3          | 104649     | CB-2328-24 |            |            | 4-1/2      | 104711     | CB-2432-36 |        |            |
| 1-5/16 | 1-1/2   | 1-3/4      | 104594   | CB-2124-14 | 4      | 104650     | CB-2328-32 | 5          | 104712     | CB-2432-40 |            |            |            |            |        |            |
|        |         | 3          | 104595   | CB-2124-24 | 1-7/16 | 1-13/16    | 3          | 104651     | CB-2329-24 | 1-1/2      | 2-1/8      | 3          | 104713     | CB-2434-24 |        |            |
| 1-5/16 | 1-9/16  | 3          | 104596   | CB-2125-24 |        |            | 3-1/4      | 104652     | CB-2329-26 | 4          | 104714     | CB-2434-32 |            |            |        |            |
|        |         | 3-1/2      | 104597   | CB-2125-28 |        |            | 3-1/2      | 104653     | CB-2329-28 | 1-1/2      | 2-1/4      | 3          | 104716     | CB-2436-24 |        |            |
|        |         | 4          | 104598   | CB-2125-32 |        |            | 4          | 104654     | CB-2329-32 |            |            | 4          | 104717     | CB-2436-32 |        |            |
|        |         | 1-5/16     | 1-5/8    | 2          |        |            | 104599     | CB-2126-16 | 4-1/4      |            |            | 104655     | CB-2329-34 | 5          | 104718 | CB-2436-40 |
| 2-1/2  | 104600  |            |          | CB-2126-20 | 5      | 104656     | CB-2329-40 | 6-1/2      | 104719     |            |            | CB-2436-52 |            |            |        |            |
| 3      | 104601  |            |          | CB-2126-24 | 1-7/16 | 1-7/8      | 3          | 104657     | CB-2330-24 | 1-9/16     | 1-13/16    | 3          | 104723     | CB-2529-24 |        |            |
| 4      | 104602  | CB-2126-32 | 4        | 104658     |        |            | CB-2330-32 | 3-1/2      | 104724     |            |            | CB-2529-28 |            |            |        |            |
| 4-3/4  | 104603  | CB-2126-38 | 4-1/2    | 104660     |        |            | CB-2330-36 | 4          | 104725     |            |            | CB-2529-32 |            |            |        |            |
| 1-5/16 | 1-11/16 | 2-1/2      | 104604   | CB-2127-20 | 5      | 104661     | CB-2330-40 | 1-9/16     | 1-15/16    | 3-1/2      | 104726     | CB-2531-28 |            |            |        |            |
|        |         | 3          | 104605   | CB-2127-24 | 1-7/16 | 1-15/16    | 2          |            |            | 104662     | CB-2331-16 | 4-1/2      | 104727     | CB-2531-36 |        |            |
|        |         | 4          | 104607   | CB-2127-32 |        |            | 3          | 104663     | CB-2331-24 | 1-5/8      | 1-7/8      | 2-1/4      | 104728     | CB-2630-18 |        |            |
| 1-5/16 | 1-13/16 | 3          | 104608   | CB-2129-24 | 3-1/2  | 104664     | CB-2331-28 | 3          | 104730     |            |            | CB-2630-24 |            |            |        |            |
|        |         | 4          | 104610   | CB-2129-32 | 4      | 104665     | CB-2331-32 | 3-3/4      | 104731     |            |            | CB-2630-30 |            |            |        |            |
| 1-5/16 | 1-7/8   | 3-1/2      | 104611   | CB-2130-28 | 4-1/2  | 104667     | CB-2331-36 | 1-5/8      | 2          | 1-3/4      | 104736     | CB-2632-14 |            |            |        |            |
|        |         | 4-1/2      | 104612   | CB-2130-36 | 5      | 104668     | CB-2331-40 |            |            | 2-1/2      | 104737     | CB-2632-20 |            |            |        |            |
| 1-3/8  | 1-1/2   | 1-3/4      | 104613   | CB-2224-14 | 5-1/2  | 104669     | CB-2331-44 |            |            | 3          | 104738     | CB-2632-24 |            |            |        |            |
|        |         | 2          | 104615   | CB-2224-16 | 1-7/16 | 2          | 4          |            |            | 104672     | CB-2332-32 | 3-1/2      | 104739     | CB-2632-28 |        |            |
|        |         | 2-1/2      | 104616   | CB-2224-20 |        |            | 1-1/2      |            |            | 1-5/8      | 2          | 104678     | CB-2426-16 | 4          | 104740 | CB-2632-32 |
| 1-3/8  | 1-5/8   | 1-1/4      | 104617   | CB-2226-10 | 1-1/2  | 1-11/16    | 2-3/4      |            |            | 104679     | CB-2427-22 | 4-1/2      | 104741     | CB-2632-36 |        |            |
|        |         | 1-1/2      | 105035   | CB-2226-12 |        |            | 1-1/2      | 1-3/4      | 1          | 104680     | CB-2428-08 | 5          | 104742     | CB-2632-40 |        |            |
|        |         | 2          | 104618   | CB-2226-16 | 1-1/4  | 104681     |            |            | CB-2428-10 | 5-1/2      | 104743     | CB-2632-44 |            |            |        |            |
| 3      | 104619  | CB-2226-24 |          |            |        |            |            |            |            |            |            |            |            |            |        |            |

\*Other sizes, tolerances, lubricants and materials are available on special orders.



| I.D.    | O.D.    | LENGTH | ITEM NO. | PART NO.   |        |            |
|---------|---------|--------|----------|------------|--------|------------|
| 1-5/8   | 2-1/8   | 3      | 104744   | CB-2634-24 |        |            |
|         |         | 4      | 104745   | CB-2634-32 |        |            |
|         |         | 4-1/2  | 104746   | CB-2634-36 |        |            |
|         |         | 5      | 104747   | CB-2634-40 |        |            |
| 1-11/16 | 1-15/16 | 3      | 104748   | CB-2731-24 |        |            |
|         |         | 3-1/2  | 104749   | CB-2731-28 |        |            |
| 1-11/16 | 2       | 3-1/2  | 104750   | CB-2732-28 |        |            |
|         |         | 4-1/2  | 104751   | CB-2732-36 |        |            |
| 1-11/16 | 2-1/16  | 3      | 104752   | CB-2733-24 |        |            |
|         |         | 3-1/2  | 104753   | CB-2733-28 |        |            |
|         |         | 4      | 104754   | CB-2733-32 |        |            |
|         |         | 4-1/2  | 104755   | CB-2733-36 |        |            |
|         |         | 5      | 104756   | CB-2733-40 |        |            |
| 1-11/16 | 2-3/16  | 2      | 104757   | CB-2733-44 |        |            |
|         |         | 2-1/2  | 104758   | CB-2735-16 |        |            |
|         |         | 3      | 104759   | CB-2735-20 |        |            |
|         |         | 3-1/2  | 104760   | CB-2735-24 |        |            |
|         |         | 4      | 104761   | CB-2735-28 |        |            |
| 1-11/16 | 2-1/4   | 4      | 104762   | CB-2735-32 |        |            |
|         |         | 4-1/2  | 104763   | CB-2735-36 |        |            |
|         |         | 5-1/2  | 104764   | CB-2735-40 |        |            |
|         |         | 3      | 104765   | CB-2736-24 |        |            |
|         |         | 4-1/2  | 104766   | CB-2736-36 |        |            |
| 1-3/4   | 2       | 1-1/2  | 104772   | CB-2832-12 |        |            |
|         |         | 2      | 104773   | CB-2832-16 |        |            |
|         |         | 2-1/4  | 104774   | CB-2832-18 |        |            |
|         |         | 2-1/2  | 104775   | CB-2832-20 |        |            |
|         |         | 3      | 104776   | CB-2832-24 |        |            |
|         |         | 4      | 104777   | CB-2832-32 |        |            |
|         |         | 4-1/2  | 104778   | CB-2832-36 |        |            |
|         |         | 5-1/4  | 104779   | CB-2832-42 |        |            |
|         |         | 3-1/2  | 104780   | CB-2833-28 |        |            |
|         |         | 1-3/4  | 2-1/8    | 2-1/2      | 105037 | CB-2834-20 |
| 2-3/4   | 104781  |        |          | CB-2834-22 |        |            |
| 3-1/4   | 104782  |        |          | CB-2834-26 |        |            |
| 3-1/2   | 104783  |        |          | CB-2834-28 |        |            |
| 4       | 104784  |        |          | CB-2834-32 |        |            |
| 4-1/4   | 104785  |        |          | CB-2834-34 |        |            |
| 5       | 104786  |        |          | CB-2834-40 |        |            |
| 5-1/2   | 104787  |        |          | CB-2834-44 |        |            |
| 1-3/4   | 2-1/4   |        |          | 1-3/4      | 104788 | CB-2836-14 |
|         |         |        |          | 2          | 104789 | CB-2836-16 |
|         |         | 2-1/2  | 104790   | CB-2836-20 |        |            |
|         |         | 3      | 104791   | CB-2836-24 |        |            |
|         |         | 3-1/2  | 104792   | CB-2836-28 |        |            |
|         |         | 4      | 104793   | CB-2836-32 |        |            |
|         |         | 4-1/4  | 104794   | CB-2836-34 |        |            |
|         |         | 5      | 104796   | CB-2836-40 |        |            |
|         |         | 1-3/4  | 2-3/8    | 3-1/2      | 104797 | CB-2838-28 |
|         |         |        |          | 4-1/2      | 104798 | CB-2838-36 |
| 5       | 104799  |        |          | CB-2838-40 |        |            |

| I.D.    | O.D.   | LENGTH | ITEM NO. | PART NO.   |
|---------|--------|--------|----------|------------|
| 1-3/4   | 2-1/2  | 6-1/2  | 104801   | CB-2840-52 |
| 1-13/16 | 2-3/16 | 4      | 104802   | CB-2935-32 |
|         |        | 5-1/4  | 104803   | CB-2935-42 |
| 1-13/16 | 2-5/16 | 4      | 104804   | CB-2937-32 |
|         |        | 5      | 104805   | CB-2937-40 |
| 1-7/8   | 2-1/8  | 2-1/2  | 104806   | CB-3034-20 |
|         |        | 3      | 104807   | CB-3034-24 |
|         |        | 4      | 104808   | CB-3034-32 |
| 1-7/8   | 2-1/4  | 3      | 104809   | CB-3036-24 |
|         |        | 3-1/4  | 104810   | CB-3036-26 |
|         |        | 4      | 104812   | CB-3036-32 |
|         |        | 5      | 104815   | CB-3036-40 |
| 1-7/8   | 2-3/8  | 3      | 104816   | CB-3038-24 |
|         |        | 4      | 104817   | CB-3038-32 |
|         |        | 5-1/4  | 104818   | CB-3038-42 |
| 1-15/16 | 2-3/16 | 2      | 104820   | CB-3135-16 |
|         |        | 3      | 104821   | CB-3135-24 |
|         |        | 4      | 104822   | CB-3135-32 |
|         |        | 3      | 104823   | CB-3136-24 |
| 1-15/16 | 2-1/4  | 4-1/2  | 104824   | CB-3136-36 |
|         |        | 3-1/2  | 104825   | CB-3137-28 |
| 1-15/16 | 2-5/16 | 4      | 104826   | CB-3137-32 |
|         |        | 5      | 104827   | CB-3137-40 |
|         |        | 5-1/2  | 104828   | CB-3137-44 |
| 1-15/16 | 2-3/8  | 6-1/4  | 104829   | CB-3137-50 |
|         |        | 3      | 104830   | CB-3138-24 |
|         |        | 4      | 104831   | CB-3138-32 |
| 1-15/16 | 2-7/16 | 5-1/2  | 104832   | CB-3138-44 |
|         |        | 3      | 104833   | CB-3139-24 |
|         |        | 4      | 104834   | CB-3139-32 |
| 1-15/16 | 2-1/2  | 5      | 104835   | CB-3139-40 |
|         |        | 5-1/2  | 104836   | CB-3139-44 |
|         |        | 3      | 104837   | CB-3140-24 |
|         |        | 5      | 104838   | CB-3140-40 |
| 2       | 2-1/4  | 2      | 104839   | CB-3236-16 |
|         |        | 2-1/2  | 104840   | CB-3236-20 |
|         |        | 3      | 104841   | CB-3236-24 |
|         |        | 3-1/2  | 104842   | CB-3236-28 |
|         |        | 3-3/4  | 104843   | CB-3236-30 |
|         |        | 4      | 104844   | CB-3236-32 |
|         |        | 4-1/2  | 104845   | CB-3236-36 |
|         |        | 5      | 104846   | CB-3236-40 |
|         |        | 2      | 304839   | M3236-16   |
|         |        | 2      | 2-3/8    | 2-1/2      |
| 3       | 104848 |        |          | CB-3238-24 |
| 3-1/2   | 104849 |        |          | CB-3238-28 |
| 4       | 104850 |        |          | CB-3238-32 |
| 4-1/2   | 104851 |        |          | CB-3238-36 |
| 2       | 2-1/2  | 2      | 105044   | CB-3240-16 |
|         |        | 2-1/2  | 104853   | CB-3240-20 |
|         |        | 3      | 104854   | CB-3240-24 |

| I.D.   | O.D.    | LENGTH | ITEM NO. | PART NO.   |
|--------|---------|--------|----------|------------|
| 2      | 2-1/2   | 3-1/2  | 104855   | CB-3240-28 |
|        |         | 4      | 104856   | CB-3240-32 |
|        |         | 4-1/2  | 104857   | CB-3240-36 |
|        |         | 5      | 104858   | CB-3240-40 |
|        |         | 5-1/2  | 104859   | CB-3240-44 |
|        |         | 6      | 104860   | CB-3240-48 |
| 2      | 2-5/8   | 4      | 104861   | CB-3242-32 |
| 2      | 2-3/4   | 6      | 105038   | CB-3244-48 |
|        |         | 6-1/2  | 104864   | CB-3244-52 |
| 2-1/8  | 2-1/2   | 3      | 104865   | CB-3440-24 |
|        |         | 4      | 104866   | CB-3440-32 |
| 2-1/8  | 2-5/8   | 4      | 104867   | CB-3442-32 |
|        |         | 5      | 104868   | CB-3442-40 |
|        |         | 6      | 104869   | CB-3442-48 |
| 2-3/16 | 2-5/8   | 4      | 104870   | CB-3542-32 |
|        |         | 5      | 104871   | CB-3542-40 |
| 2-3/16 | 2-11/16 | 3-1/2  | 104872   | CB-3543-28 |
|        |         | 4      | 104873   | CB-3543-32 |
|        |         | 4-1/2  | 104874   | CB-3543-36 |
| 2-3/16 | 2-3/4   | 5      | 104875   | CB-3543-40 |
|        |         | 4-1/2  | 104876   | CB-3544-36 |
|        |         | 5-1/4  | 104877   | CB-3544-42 |
| 2-3/16 | 2-7/8   | 6      | 104878   | CB-3544-48 |
|        |         | 4-1/2  | 104879   | CB-3546-36 |
|        |         | 3      | 105039   | CB-3640-24 |
| 2-1/4  | 2-1/2   | 3-1/2  | 104880   | CB-3640-28 |
|        |         | 4      | 104881   | CB-3640-32 |
|        |         | 3      | 104882   | CB-3642-24 |
| 2-1/4  | 2-5/8   | 4      | 104883   | CB-3642-32 |
|        |         | 5      | 104884   | CB-3642-40 |
|        |         | 4-3/4  | 104886   | CB-3643-38 |
| 2-1/4  | 2-3/4   | 3      | 105040   | CB-3644-24 |
|        |         | 3-1/2  | 104887   | CB-3644-28 |
| 2-1/4  | 3       | 4      | 104888   | CB-3644-32 |
|        |         | 4-1/2  | 104889   | CB-3644-36 |
|        |         | 5      | 104890   | CB-3644-40 |
|        |         | 6      | 104891   | CB-3644-48 |
|        |         | 6-1/2  | 104892   | CB-3644-52 |
|        |         | 3-1/2  | 104893   | CB-3648-28 |
| 2-1/4  | 3       | 5      | 104894   | CB-3648-40 |
|        |         | 6-1/2  | 104895   | CB-3650-52 |
|        |         | 4      | 104896   | CB-3844-32 |
| 2-3/8  | 2-3/4   | 5      | 104897   | CB-3844-40 |
|        |         | 6      | 104898   | CB-3844-48 |
|        |         | 4      | 104899   | CB-3846-32 |
| 2-3/8  | 2-7/8   | 5      | 104900   | CB-3846-40 |
|        |         | 6      | 104901   | CB-3846-48 |
|        |         | 4      | 104902   | CB-3944-32 |
| 2-7/16 | 2-3/4   | 5      | 104903   | CB-3944-40 |
|        |         | 3      | 104905   | CB-3946-24 |
| 2-7/16 | 2-7/8   | 5      | 104906   | CB-3946-40 |
|        |         | 4      | 104907   | CB-3947-32 |
| 2-7/16 | 2-15/16 | 5      | 104908   | CB-3947-40 |
|        |         | 6-1/4  | 104909   | CB-3947-50 |
|        |         | 3-3/4  | 104911   | CB-3948-30 |
| 2-7/16 | 3       | 5      | 104912   | CB-3948-40 |
|        |         | 6-1/4  | 104913   | CB-3948-50 |
|        |         | 3      | 104914   | CB-4044-24 |
| 2-1/2  | 2-3/4   | 4      | 104915   | CB-4044-32 |
|        |         | 5      | 104917   | CB-4044-40 |
| 2-1/2  | 2-7/8   | 3-1/4  | 104919   | CB-4046-26 |
|        |         | 4-1/2  | 104921   | CB-4046-36 |

\*Other sizes, tolerances, lubricants and materials are available on special orders.



| I.D.    | O.D.   | LENGTH | ITEM NO. | PART NO.   | I.D.   | O.D.       | LENGTH     | ITEM NO. | PART NO.   | I.D.   | O.D.       | LENGTH | ITEM NO. | PART NO.   |  |  |
|---------|--------|--------|----------|------------|--------|------------|------------|----------|------------|--------|------------|--------|----------|------------|--|--|
| 2-1/2   | 3      | 3      | 104923   | CB-4048-24 | 3      | 3-3/8      | 4-1/2      | 104973   | CB-4854-36 | 5      | 5-1/2      | 6      | 105025   | CB-8088-48 |  |  |
|         |        | 3-3/4  | 104924   | CB-4048-30 |        |            | 8          | 104974   | CB-4854-64 |        |            | 7      | 105026   | CB-8088-56 |  |  |
|         |        | 4      | 104925   | CB-4048-32 | 3      | 3-1/2      | 3          | 104975   | CB-4856-24 |        |            | 8      | 105027   | CB-8088-64 |  |  |
|         |        | 5      | 104926   | CB-4048-40 |        |            | 4          | 104976   | CB-4856-32 | 5      | 6          | 7      | 105028   | CB-8096-56 |  |  |
|         |        | 6      | 104927   | CB-4048-48 |        |            | 4-1/2      | 104977   | CB-4856-36 |        |            | 8      | 105029   | CB-8096-64 |  |  |
|         |        | 7      | 104928   | CB-4048-56 |        |            | 5-1/2      | 105042   | CB-4856-44 |        |            | 9      | 105030   | CB-8096-72 |  |  |
|         |        |        |          | 6          | 104978 | CB-4856-48 |            |          |            |        |            |        |          |            |  |  |
|         |        |        |          | 9          | 104979 | CB-4856-72 |            |          |            |        |            |        |          |            |  |  |
| 2-1/2   | 3-1/8  | 3-1/2  | 104929   | CB-4050-28 | 3      | 3-5/8      | 5          | 104980   | CB-4858-40 |        |            |        |          |            |  |  |
|         |        | 4      | 104930   | CB-4050-32 |        |            | 6-1/2      | 104981   | CB-4858-52 |        |            |        |          |            |  |  |
|         |        | 4-1/2  | 104931   | CB-4050-36 |        |            | 8          | 104982   | CB-4858-64 |        |            |        |          |            |  |  |
|         |        | 6-3/4  | 104932   | CB-4050-54 |        |            |            |          |            |        |            |        |          |            |  |  |
| 2-1/2   | 3-1/4  | 4      | 104933   | CB-4052-32 | 3      | 3-3/4      | 6-1/4      | 104983   | CB-4860-50 |        |            |        |          |            |  |  |
|         |        | 5      | 104934   | CB-4052-40 | 3      | 4          | 6-1/2      | 104984   | CB-4864-52 |        |            |        |          |            |  |  |
|         |        | 6      | 104935   | CB-4052-48 | 3-1/4  | 3-1/2      | 4          | 104985   | CB-5256-32 |        |            |        |          |            |  |  |
|         |        | 7-1/4  | 104936   | CB-4052-58 | 3-1/4  | 3-3/4      | 5          | 104986   | CB-5260-40 |        |            |        |          |            |  |  |
|         |        |        | 6        | 104987     |        |            | CB-5260-48 |          |            |        |            |        |          |            |  |  |
|         |        |        | 9        | 104988     |        |            | CB-5260-72 |          |            |        |            |        |          |            |  |  |
| 2-1/2   | 3-1/2  | 6-1/2  | 104937   | CB-4056-52 |        |            |            |          |            |        |            |        |          |            |  |  |
| 2-5/8   | 3      | 3      | 104939   | CB-4248-24 | 3-7/16 | 3-15/16    | 4-1/2      | 104989   | CB-5563-36 |        |            |        |          |            |  |  |
|         |        | 4      | 104941   | CB-4248-32 |        |            | 6-1/2      | 104990   | CB-5563-52 |        |            |        |          |            |  |  |
|         |        | 5      | 104942   | CB-4248-40 | 3-1/2  | 4          | 4          | 104992   | CB-5664-32 |        |            |        |          |            |  |  |
|         |        |        | 5-1/2    | 104993     |        |            | CB-5664-44 |          |            |        |            |        |          |            |  |  |
|         |        |        | 6        | 105043     |        |            | CB-5664-48 |          |            |        |            |        |          |            |  |  |
|         |        |        | 7        | 104994     |        |            | CB-5664-56 |          |            |        |            |        |          |            |  |  |
| 2-5/8   | 3-1/8  | 5      | 104943   | CB-4250-40 | 3-1/2  | 4-1/8      | 6          | 104995   | CB-5666-48 |        |            |        |          |            |  |  |
|         |        | 6      | 104944   | CB-4250-48 |        |            | 3-1/2      | 4-1/4    | 4-1/2      | 104997 | CB-5668-36 |        |          |            |  |  |
|         |        | 7-1/4  | 104945   | CB-4250-58 |        |            |            |          | 7          | 104998 | CB-5668-56 |        |          |            |  |  |
| 2-5/8   | 3-1/4  | 7      | 104946   | CB-4252-56 |        |            | 9-3/4      | 104999   | CB-5668-78 |        |            |        |          |            |  |  |
| 2-5/8   | 3-3/8  | 6-1/2  | 104947   | CB-4254-52 |        |            |            |          |            |        |            |        |          |            |  |  |
| 2-11/16 | 3-3/16 | 4      | 104948   | CB-4351-32 | 3-3/4  | 4-1/4      | 5          | 105000   | CB-6068-40 |        |            |        |          |            |  |  |
|         |        | 5      | 104949   | CB-4351-40 |        |            | 7          | 105001   | CB-6068-56 |        |            |        |          |            |  |  |
|         |        | 6-1/4  | 104950   | CB-4351-50 | 3-3/4  | 4-1/2      | 6-1/2      | 105002   | CB-6072-52 |        |            |        |          |            |  |  |
|         |        |        | 4        | 4-1/2      |        |            | 4          | 105003   | CB-6472-32 |        |            |        |          |            |  |  |
|         |        |        |          |            |        |            | 6          | 105004   | CB-6472-48 |        |            |        |          |            |  |  |
| 2-3/4   | 3-1/8  | 4      | 104951   | CB-4450-32 |        |            | 7          | 105005   | CB-6472-56 |        |            |        |          |            |  |  |
|         |        | 5      | 104952   | CB-4450-40 | 4      | 4-3/4      | 5          | 105006   | CB-6476-40 |        |            |        |          |            |  |  |
|         |        | 6      | 104953   | CB-4450-48 |        |            | 6          | 105007   | CB-6476-48 |        |            |        |          |            |  |  |
|         |        |        |          |            |        |            | 7          | 105008   | CB-6476-56 |        |            |        |          |            |  |  |
| 2-3/4   | 3-1/4  | 4      | 104954   | CB-4452-32 | 4      | 5          | 5          | 105009   | CB-6480-40 |        |            |        |          |            |  |  |
|         |        | 5      | 104955   | CB-4452-40 |        |            | 6          | 105010   | CB-6480-48 |        |            |        |          |            |  |  |
|         |        | 6      | 104956   | CB-4452-48 |        |            | 7          | 105011   | CB-6480-56 |        |            |        |          |            |  |  |
|         |        | 7      | 104957   | CB-4452-56 |        |            |            |          |            |        |            |        |          |            |  |  |
| 2-3/4   | 3-3/8  | 4      | 104958   | CB-4454-32 | 4-1/4  | 4-3/4      | 5          | 105012   | CB-6876-40 |        |            |        |          |            |  |  |
|         |        | 6-1/2  | 104959   | CB-4454-52 |        |            | 6          | 105013   | CB-6876-48 |        |            |        |          |            |  |  |
|         |        |        |          |            |        |            | 7          | 105014   | CB-6876-56 |        |            |        |          |            |  |  |
| 2-3/4   | 3-1/2  | 6-1/2  | 104960   | CB-4456-52 | 4-1/4  | 5          | 5          | 105015   | CB-6880-40 |        |            |        |          |            |  |  |
| 2-7/8   | 3-3/8  | 4      | 104961   | CB-4654-32 |        |            | 6          | 105016   | CB-6880-48 |        |            |        |          |            |  |  |
|         |        | 6      | 104962   | CB-4654-48 |        |            | 7          | 105017   | CB-6880-56 |        |            |        |          |            |  |  |
|         |        | 8      | 104963   | CB-4654-64 | 4-1/2  | 5          | 6          | 105019   | CB-7280-48 |        |            |        |          |            |  |  |
| 2-7/8   | 3-1/2  | 4-1/2  | 104964   | CB-4656-36 |        |            | 7          | 105020   | CB-7280-56 |        |            |        |          |            |  |  |
|         |        | 6-3/4  | 104965   | CB-4656-54 |        |            | 8          | 105021   | CB-7280-64 |        |            |        |          |            |  |  |
| 2-15/16 | 3-7/16 | 3-1/2  | 104967   | CB-4755-28 | 4-1/2  | 5-1/2      | 6          | 105022   | CB-7288-48 |        |            |        |          |            |  |  |
|         |        | 5      | 104968   | CB-4755-40 |        |            | 7          | 105023   | CB-7288-56 |        |            |        |          |            |  |  |
|         |        | 6-1/2  | 104969   | CB-4755-52 |        |            | 8          | 105024   | CB-7288-64 |        |            |        |          |            |  |  |
|         |        |        |          |            |        |            |            |          |            |        |            |        |          |            |  |  |

\*Other sizes, tolerances, lubricants and materials are available on special orders.





| I.D.  | O.D.   | ITEM NO.  | PART NO.  | AVG. WGT. |
|-------|--------|-----------|-----------|-----------|
| SOLID | 3/8    | 106500    | BS0003-13 | .56       |
|       | 1/2    | 106501    | BS0004-13 | 1         |
|       | 5/8    | 106502    | BS0005-13 | 1.5       |
|       | 3/4    | 106503    | BS0006-13 | 2.1       |
|       | 7/8    | 106504    | BS0007-13 | 2.8       |
|       | 1      | 106505    | BS0008-13 | 3.7       |
|       | 1-1/8  | 106506    | BS0009-13 | 4.6       |
|       | 1-1/4  | 106507    | BS0010-13 | 5.6       |
|       | 1-3/8  | 106508    | BS0011-13 | 6.8       |
|       | 1-1/2  | 106509    | BS0012-13 | 8.0       |
|       | 1-5/8  | 106510    | BS0013-13 | 9.4       |
|       | 1-3/4  | 106511    | BS0014-13 | 10.8      |
|       | 1-7/8  | 106512    | BS0015-13 | 12.4      |
|       | 2      | 106513    | BS0016-13 | 14.0      |
|       | 2-1/8  | 106514    | BS0017-13 | 16.0      |
|       | 2-1/4  | 106515    | BS0018-13 | 17.8      |
|       | 2-3/8  | 106516    | BS0019-13 | 19.8      |
|       | 2-1/2  | 106517    | BS0020-13 | 21.9      |
|       | 2-5/8  | 106518    | BS0021-13 | 24.1      |
|       | 2-3/4  | 106519    | BS0022-13 | 26.4      |
|       | 3      | 106521    | BS0024-13 | 31.4      |
|       | 3-1/4  | 106522    | BS0026-13 | 36.7      |
|       | 3-1/2  | 106523    | BS0028-13 | 42.5      |
|       | 3-3/4  | 106524    | BS0030-13 | 48.8      |
|       | 4      | 106525    | BS0032-13 | 56.4      |
|       | 4-1/4  | 106526    | BS0034-13 | 63.5      |
|       | 4-1/2  | 106527    | BS0036-13 | 71.1      |
|       | 4-3/4  | 106528    | BS0038-13 | 79.1      |
|       | 5      | 106529    | BS0040-13 | 88.6      |
| 5-1/2 | 106530 | BS0044-13 | 107.0     |           |
| 6     | 106531 | BS0048-13 | 126.9     |           |
| 6-1/2 | 106532 | BS0052-13 | 148.0     |           |
| 7     | 106533 | BS0056-13 | 171.9     |           |
| 7-1/2 | 106534 | BS0060-13 | 196.9     |           |
| 8     | 106535 | BS0064-13 | 223.6     |           |
| 9     | 106537 | BS0072-13 | 282.2     |           |
| 1/2   | 1      | 106001    | BC0408-13 | 3.0       |
|       | 1-1/8  | 106002    | BC0409-13 | 3.9       |
|       | 1-1/4  | 106003    | BC0410-13 | 4.9       |
|       | 1-1/2  | 106005    | BC0412-13 | 7.3       |
|       | 1-3/4  | 106006    | BC0414-13 | 10.2      |
|       | 2      | 106007    | BC0416-13 | 13.4      |
| 5/8   | 1      | 106008    | BC0508-13 | 2.5       |
|       | 1-1/8  | 106009    | BC0509-13 | 3.5       |
|       | 1-1/4  | 106010    | BC0510-13 | 4.5       |
|       | 1-3/8  | 106011    | BC0511-13 | 5.6       |
|       | 2      | 106015    | BC0516-13 | 13.6      |
| 3/4   | 1      | 106017    | BC0608-13 | 2.0       |
|       | 1-1/8  | 106018    | BC0609-13 | 2.9       |
|       | 1-1/4  | 106019    | BC0610-13 | 4.0       |
|       | 1-3/8  | 106020    | BC0611-13 | 5.1       |
|       | 1-1/2  | 106021    | BC0612-13 | 6.4       |
|       | 1-3/4  | 106023    | BC0614-13 | 9.2       |
|       | 2      | 106025    | BC0616-13 | 12.4      |
|       | 2-1/4  | 106027    | BC0618-13 | 16.1      |
|       | 2-1/2  | 106028    | BC0620-13 | 20.2      |
|       | 2-3/4  | 106029    | BC0622-13 | 24.7      |

| I.D.  | O.D.  | ITEM NO. | PART NO.  | AVG. WGT. |
|-------|-------|----------|-----------|-----------|
| 7/8   | 1-1/8 | 106030   | BC0709-13 | 2.3       |
|       | 1-1/4 | 106031   | BC0710-13 | 3.3       |
|       | 1-3/8 | 106032   | BC0711-13 | 4.5       |
|       | 1-1/2 | 106033   | BC0712-13 | 5.7       |
|       | 1-5/8 | 106034   | BC0713-13 | 7.1       |
|       | 1-3/4 | 106035   | BC0714-13 | 8.5       |
|       | 2     | 106037   | BC0716-13 | 11.8      |
| 1     | 1-1/4 | 106040   | BC0810-13 | 2.6       |
|       | 1-3/8 | 106041   | BC0811-13 | 3.7       |
|       | 1-1/2 | 106042   | BC0812-13 | 5.0       |
|       | 1-5/8 | 106043   | BC0813-13 | 6.3       |
|       | 1-3/4 | 106044   | BC0814-13 | 7.8       |
|       | 2     | 106046   | BC0816-13 | 11.0      |
|       | 2-1/4 | 106048   | BC0818-13 | 14.7      |
|       | 2-3/8 | 106049   | BC0819-13 | 16.7      |
|       | 2-1/2 | 106050   | BC0820-13 | 18.8      |
|       | 2-3/4 | 106051   | BC0822-13 | 23.3      |
|       | 3     | 106052   | BC0824-13 | 28.3      |
|       | 3-1/4 | 106053   | BC0826-13 | 33.7      |
|       | 3-1/2 | 106054   | BC0828-13 | 39.5      |
|       | 4     | 106055   | BC0832-13 | 53.3      |
|       | 2     | 306046   | MCB1632   | 11.0      |
| 1-1/8 | 1-5/8 | 106058   | BC0913-13 | 5.4       |
|       | 1-7/8 | 106060   | BC0915-13 | 8.5       |
|       | 2     | 106061   | BC0916-13 | 10.2      |
| 1-1/4 | 1-1/2 | 106068   | BC1012-13 | 3.0       |
|       | 1-5/8 | 106069   | BC1013-13 | 4.4       |
|       | 1-3/4 | 106070   | BC1014-13 | 5.9       |
|       | 1-7/8 | 106071   | BC1015-13 | 7.5       |
|       | 2     | 106072   | BC1016-13 | 9.2       |
|       | 2-1/4 | 106074   | BC1018-13 | 12.9      |
|       | 2-1/2 | 106076   | BC1020-13 | 17.0      |
|       | 2-3/4 | 106078   | BC1022-13 | 21.5      |
|       | 3     | 106080   | BC1024-13 | 26.4      |
|       | 3-1/4 | 106081   | BC1026-13 | 31.8      |
|       | 3-1/2 | 106082   | BC1028-13 | 37.6      |
|       | 4     | 106083   | BC1032-13 | 51.8      |
| 1-3/8 | 1-3/4 | 106085   | BC1114-13 | 4.9       |
|       | 2     | 106087   | BC1116-13 | 8.1       |
|       | 2-1/8 | 106088   | BC1117-13 | 9.9       |
|       | 2-1/2 | 106091   | BC1120-13 | 15.9      |
|       | 3     | 106094   | BC1124-13 | 25.4      |
| 1-1/2 | 1-3/4 | 106095   | BC1214-13 | 3.7       |
|       | 2     | 106097   | BC1216-13 | 6.9       |
|       | 2-1/8 | 106098   | BC1217-13 | 8.7       |
|       | 2-1/4 | 106099   | BC1218-13 | 10.6      |
|       | 2-3/8 | 106100   | BC1219-13 | 12.6      |
|       | 2-1/2 | 106101   | BC1220-13 | 14.7      |
|       | 2-3/4 | 106103   | BC1222-13 | 19.2      |
|       | 3     | 106104   | BC1224-13 | 24.2      |
|       | 3-1/4 | 106105   | BC1226-13 | 29.6      |
|       | 3-1/2 | 106106   | BC1228-13 | 35.4      |
|       | 3-3/4 | 106107   | BC1230-13 | 41.6      |
|       | 4     | 106108   | BC1232-13 | 49.6      |
|       | 4-1/2 | 106109   | BC1236-13 | 64.3      |

| I.D.  | O.D.  | ITEM NO. | PART NO.  | AVG. WGT. |
|-------|-------|----------|-----------|-----------|
| 1-5/8 | 2     | 106110   | BC1316-13 | 5.6       |
|       | 2-1/8 | 106111   | BC1317-13 | 7.4       |
|       | 2-1/4 | 106112   | BC1318-13 | 9.3       |
|       | 3     | 106117   | BC1324-13 | 22.9      |
| 1-3/4 | 2     | 106118   | BC1416-13 | 4.3       |
|       | 2-1/4 | 106120   | BC1418-13 | 7.9       |
|       | 2-3/8 | 106121   | BC1419-13 | 9.9       |
|       | 2-1/2 | 106122   | BC1420-13 | 12.0      |
|       | 2-5/8 | 106123   | BC1421-13 | 14.2      |
|       | 2-3/4 | 106124   | BC1422-13 | 16.6      |
|       | 3     | 106126   | BC1424-13 | 21.5      |
|       | 3-1/4 | 106127   | BC1426-13 | 26.9      |
|       | 3-1/2 | 106128   | BC1428-13 | 32.7      |
|       | 3-3/4 | 106129   | BC1430-13 | 38.9      |
|       | 4     | 106130   | BC1432-13 | 47.0      |
|       | 2-3/8 | 106133   | BC1519-13 | 8.4       |
| 1-7/8 | 2-5/8 | 106135   | BC1521-13 | 12.7      |
| 2     | 2-1/4 | 106140   | BC1618-13 | 4.8       |
|       | 2-1/2 | 106141   | BC1620-13 | 8.9       |
|       | 2-5/8 | 106142   | BC1621-13 | 11.1      |
|       | 2-3/4 | 106143   | BC1622-13 | 13.4      |
|       | 2-7/8 | 106144   | BC1623-13 | 15.9      |
|       | 3     | 106145   | BC1624-13 | 18.4      |
|       | 3-1/4 | 106146   | BC1626-13 | 23.8      |
|       | 3-1/2 | 106147   | BC1628-13 | 29.6      |
|       | 3-3/4 | 106148   | BC1630-13 | 35.8      |
|       | 4     | 106149   | BC1632-13 | 43.9      |
|       | 4-1/2 | 106150   | BC1636-13 | 58.6      |
|       | 5     | 106151   | BC1640-13 | 76.5      |
|       | 5-1/2 | 106152   | BC1644-13 | 95.6      |
|       | 6     | 106153   | BC1648-13 | 115.0     |
| 2-1/8 | 2-5/8 | 106154   | BC1721-13 | 9.4       |
|       | 2-3/4 | 106155   | BC1722-13 | 11.7      |
|       | 2-7/8 | 106156   | BC1723-13 | 14.2      |
| 2-1/4 | 2-3/4 | 106161   | BC1822-13 | 9.9       |
|       | 2-7/8 | 106162   | BC1823-13 | 12.3      |
|       | 3     | 106163   | BC1824-13 | 14.8      |
|       | 3-1/4 | 106165   | BC1826-13 | 20.2      |
|       | 3-1/2 | 106166   | BC1828-13 | 26        |
|       | 3-3/4 | 106167   | BC1830-13 | 32.2      |
|       | 4     | 106168   | BC1832-13 | 40.5      |
|       | 4-1/4 | 106169   | BC1834-13 | 47.5      |
| 2-3/8 | 2-7/8 | 106170   | BC1923-13 | 10.3      |
|       | 3     | 106171   | BC1924-13 | 12.8      |
|       | 3-1/4 | 106172   | BC1926-13 | 18.2      |
|       | 3-1/2 | 106173   | BC1928-13 | 24.1      |
| 2-1/2 | 3     | 106176   | BC2024-13 | 10.8      |
|       | 3-1/4 | 106178   | BC2026-13 | 16.2      |
|       | 3-1/2 | 106179   | BC2028-13 | 22.1      |
|       | 3-3/4 | 106180   | BC2030-13 | 28.2      |
|       | 4     | 106181   | BC2032-13 | 36.5      |
|       | 4-1/4 | 106182   | BC2034-13 | 43.7      |
|       | 4-1/2 | 106183   | BC2036-13 | 51.2      |

\*Other sizes, tolerances, lubricants and materials are available on special orders.





| I.D.  | O.D.   | ITEM NO.  | PART NO.  | AVG. WGT. |
|-------|--------|-----------|-----------|-----------|
| 2-1/2 | 4-3/4  | 106184    | BC2038-13 | 59.2      |
|       | 5      | 106185    | BC2040-13 | 69.1      |
|       | 5-1/2  | 106186    | BC2044-13 | 87.8      |
|       | 6      | 106187    | BC2048-13 | 107.6     |
| 2-5/8 | 3-1/2  | 106188    | BC2128-13 | 19.8      |
| 2-3/4 | 3-1/4  | 106192    | BC2226-13 | 12.6      |
|       | 3-1/2  | 106193    | BC2228-13 | 17.7      |
|       | 3-3/4  | 106194    | BC2230-13 | 23.8      |
|       | 4      | 106195    | BC2232-13 | 32.2      |
|       | 4-1/4  | 106196    | BC2234-13 | 39.4      |
|       | 4-1/2  | 106197    | BC2236-13 | 47        |
| 4-3/4 | 106198 | BC2238-13 | 54.9      |           |
| 2-7/8 | 4      | 106199    | BC2332-13 | 29.8      |
| 3     | 3-1/2  | 106200    | BC2428-13 | 12.8      |
|       | 3-3/4  | 106201    | BC2430-13 | 19.1      |
|       | 4      | 106202    | BC2432-13 | 27.5      |
|       | 4-1/4  | 106203    | BC2434-13 | 34.7      |
|       | 4-1/2  | 106204    | BC2436-13 | 42.2      |
|       | 4-3/4  | 106205    | BC2438-13 | 50.2      |
|       | 5      | 106206    | BC2440-13 | 60.2      |
|       | 5-1/2  | 106207    | BC2444-13 | 78.9      |
|       | 6      | 106208    | BC2448-13 | 98.8      |
|       | 6-1/2  | 106209    | BC2452-13 | 120.4     |
| 3-1/4 | 4      | 106210    | BC2632-13 | 22.2      |
|       | 4-1/4  | 106211    | BC2634-13 | 29.5      |
|       | 4-1/2  | 106212    | BC2636-13 | 37        |
|       | 4-3/4  | 106213    | BC2638-13 | 45        |
|       | 5      | 106214    | BC2640-13 | 55.2      |
| 3-1/2 | 4      | 106216    | BC2832-13 | 16.7      |
|       | 4-1/4  | 106217    | BC2834-13 | 23.8      |
|       | 4-1/2  | 106218    | BC2836-13 | 31.5      |
|       | 4-3/4  | 106219    | BC2838-13 | 39.4      |
|       | 5      | 106220    | BC2840-13 | 49.5      |
|       | 5-1/2  | 106221    | BC2844-13 | 68.3      |
|       | 6      | 106222    | BC2848-13 | 88.1      |
| 6-1/2 | 106223 | BC2852-13 | 109.8     |           |
| 3-3/4 | 4-1/2  | 106224    | BC3036-13 | 25.3      |
|       | 4-3/4  | 106225    | BC3038-13 | 33.4      |
|       | 5      | 106226    | BC3040-13 | 43.7      |
|       | 5-1/2  | 106228    | BC3044-13 | 62.2      |
|       | 6      | 106229    | BC3048-13 | 82.1      |

### Special Products Available

- Larger diameter 13" bars
- Longer length bars up to 105"
- Special bearings machined per print

| I.D.  | O.D.  | ITEM NO. | PART NO.  | AVG. WGT. |
|-------|-------|----------|-----------|-----------|
| 4     | 4-1/2 | 106230   | BC3236-13 | 19        |
|       | 4-3/4 | 106231   | BC3238-13 | 27        |
|       | 5     | 106232   | BC3240-13 | 37.2      |
|       | 5-1/4 | 106233   | BC3242-13 | 46.5      |
|       | 5-1/2 | 106234   | BC3244-13 | 55.9      |
|       | 6     | 106235   | BC3248-13 | 75.9      |
|       | 6-1/2 | 106236   | BC3252-13 | 97.5      |
|       | 7     | 106237   | BC3256-13 | 120.8     |
| 4-1/4 | 5-1/4 | 106241   | BC3442-13 | 38.4      |
|       | 5-1/2 | 106242   | BC3444-13 | 49.0      |
|       | 6     | 106243   | BC3448-13 | 69.0      |
|       | 6-1/2 | 106244   | BC3452-13 | 90.6      |
| 4-1/2 | 5     | 106245   | BC3640-13 | 23.2      |
|       | 5-1/2 | 106246   | BC3644-13 | 41.9      |
|       | 6     | 106247   | BC3648-13 | 61.7      |
|       | 6-1/2 | 106248   | BC3652-13 | 83.4      |
|       | 7     | 106249   | BC3656-13 | 106.8     |
| 4-3/4 | 5-3/4 | 106250   | BC3846-13 | 43.5      |
|       | 6     | 106251   | BC3848-13 | 54.2      |
|       | 6-1/2 | 106252   | BC3852-13 | 75.8      |
| 5     | 6     | 106255   | BC4048-13 | 46.0      |
|       | 6-1/2 | 106256   | BC4052-13 | 67.6      |
|       | 7     | 106257   | BC4056-13 | 91        |

| I.D.  | O.D.  | ITEM NO. | PART NO.  | AVG. WGT. |
|-------|-------|----------|-----------|-----------|
| 5     | 7-1/2 | 106258   | BC4060-13 | 116.0     |
|       | 8     | 106259   | BC4064-13 | 142.8     |
|       | 9     | 106260   | BC4072-13 | 201.3     |
| 5-1/4 | 7     | 106262   | BC4256-13 | 82.5      |
| 5-1/2 | 6-1/2 | 106264   | BC4452-13 | 50.2      |
|       | 7     | 106265   | BC4456-13 | 73.5      |
|       | 7-1/2 | 106266   | BC4460-13 | 98.5      |
|       | 8     | 106267   | BC4464-13 | 125.4     |
| 5-3/4 | 6-3/4 | 106268   | BC4654-13 | 51.7      |
|       | 7-1/2 | 106269   | BC4660-13 | 89.3      |
| 6     | 6-3/4 | 106272   | BC4854-13 | 41.4      |
|       | 7     | 106273   | BC4856-13 | 54.5      |
|       | 7-1/2 | 106274   | BC4860-13 | 79.5      |
|       | 8     | 106275   | BC4864-13 | 106.1     |
|       | 8-1/2 | 106276   | BC4868-13 | 134.6     |
| 6-1/2 | 7-1/2 | 106279   | BC5260-13 | 58.7      |
|       | 8     | 106280   | BC5264-13 | 85.4      |
|       | 9     | 106281   | BC5272-13 | 144       |
| 7     | 8     | 106284   | BC5664-13 | 62.9      |
|       | 9     | 106285   | BC5672-13 | 121.4     |
|       | 10    | 106292   | BC6480-13 | 131.8     |
| 8     | 9     | 106291   | BC6472-13 | 71.3      |
|       | 10    | 106292   | BC6480-13 | 131.8     |
| 9     | 10    | 106295   | BC7280-13 | 78.8      |

### Finish Allowances

Actual sizes provided approximate allowances for finish as follows:

#### Outside Diameter

0 - 4"  
4 - 5"  
5 - 9"

#### Finish I.D. & O.D.

1/32" .03125"  
1/16" .06250"  
3/32" .09375"

### Maximum Values (PV = P x V)

| MATERIAL                    | PV      | P-LOAD | V-SFM | Temperature Range |
|-----------------------------|---------|--------|-------|-------------------|
| <b>POWDERED METAL</b>       |         |        |       |                   |
| 1. Iron (SAE 850)           | 30,000  | 3,000  | 400   | -----             |
| 2. Bronze (SAE 841)         | 50,000  | 2,000  | 1,200 | 220° F            |
| 3. Iron - Copper (SAE 863)  | 35,000  | 4,000  | 225   | 10° to 220° F     |
| 4. Heat Treated Iron Copper | 75,000  | 8,000  | 35    | -----             |
| <b>CAST BRONZE</b>          |         |        |       |                   |
| 1. Manganese Bronze (C863)  | 150,000 | 8,000  | 100   | -450° to + 400° F |
| 2. Aluminum Bronze (C954)   | 125,000 | 4,000  | 225   | -450° to + 750° F |
| 3. Bronze (SAE 660 / C932)  | 75,000  | 3,000  | 750   | -450° to + 450° F |
| <b>STEEL BACKED</b>         |         |        |       |                   |
| 1. TU Self-Lubricating      | 102,000 | 36,250 | 2,000 | -328° to + 536° F |
| 2. TP Self-Lube - Lead Free | 102,000 | 36,250 | 2,000 | -328° to + 536° F |

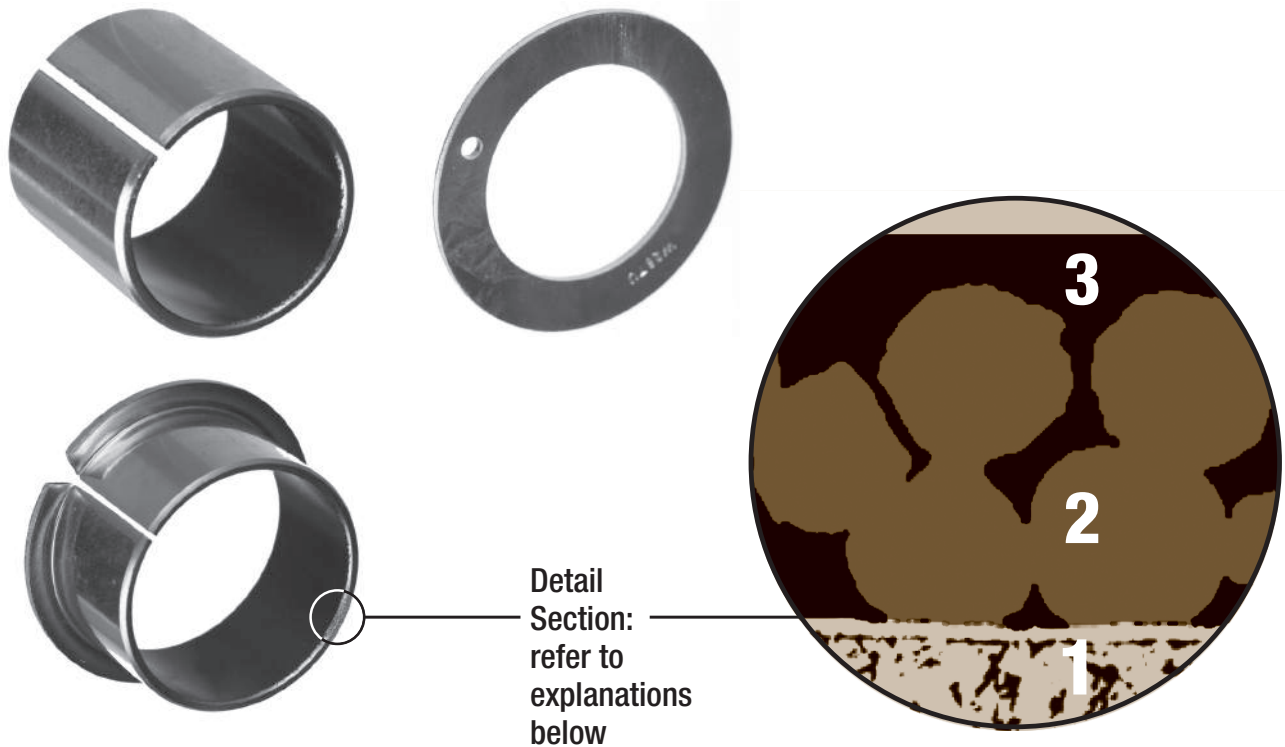

Detail Section: refer to explanations below

TU™ and TP™ are composites of the following materials which are used to produce self-lubricating dry sliding bearings

## TU™ - STEEL-BACKED PTFE LINED

### STRUCTURE

1. Low carbon **STEEL** backing allows for extremely high load capacity ( 0.50 - 2.7 mm thickness )
2. Sintered **BRONZE** offers optimal heat dispersion ( 0.20 - 3.5 mm thickness )
3. **PTFE** with lead sliding surface creates a low friction coefficient and allows for a wide temperature range ( 0.20 mm thickness )

### FEATURES

Self-lubricating, dry running for use where many oiled bearings fail. Low coefficient of friction, low wear, forms an oxide type solid lubricant film, suitable for linear, rotary and oscillating applications. High chemical resistance and low moisture absorption and swelling. Performance increases with lubrication. REACH, DFARS compliant.

## TP™ - LEAD-FREE STEEL-BACKED PTFE LINED

### STRUCTURE

1. Low carbon **STEEL** backing allows for extremely high load capacity ( 0.50 - 2.7 mm thickness )
2. Sintered **BRONZE** offers optimal heat dispersion ( 0.20 - 3.5 mm thickness )
3. **PTFE** with lead-free fibers creates a low friction coefficient and allows for a wide temperature range ( 0.02 mm thickness )

### FEATURES

*Lead-Free*, self lubricating, dry running for use where many oiled bearing fail. Low coefficient of friction, low wear, forms an oxide type solid lubricant film, suitable for linear, rotary and oscillating applications. High chemical resistance and low moisture absorption and swelling. Performance increases with lubrication. RoHS, REACH, EVL, WEEE & DFARS compliant.

### DESIGN PARAMETERS

**LOADS - P** Dynamic pressures up to 20,300 psi ( 140 N/mm<sup>2</sup> ); static loads up to 36,250 psi ( 250 N/mm<sup>2</sup> )

**SPEEDS-V** Speeds up to 2,000 sfpm ( 10 m/s ) with lubrication

**PERFORMANCE - PV** PV's up to 51,000 psi-sfpm ( 1.8 N/mm<sup>2</sup> x m/s ) for continuous loads, 102,000 psi-sfpm ( 3.6 N/mm<sup>2</sup> x m/s ) for short-term use and 26,000 psi-sfpm ( .9 N/mm<sup>2</sup> x m/s ) for alternating loads. Performance increases when lubricated.

**TEMPERATURES** From -328 to +536° F ( -200 to + 280° C ).

## CALCULATION of the SERVICE LIFE ( $L_h = \text{hours}$ )

| Description                            | Symbol    | Units of Measure |
|----------------------------------------|-----------|------------------|
| Internal diameter of the bearing       | $D_1$     | mm               |
| Internal diameter of the thrust washer | $D_4$     | mm               |
| External diameter of the thrust washer | $D_5$     | mm               |
| Length of the bearing                  | $B$       | mm               |
| Load on the bearing                    | $L$       | N=(Newton)       |
| Speed of rotation                      | $N$       | r.p.m.           |
| Angle of oscillation                   | $\varphi$ | ° degrees        |
| Frequency of oscillation               | $N_{osz}$ | cycles/minutes   |
| Nominal life                           | $L_h$     | hours            |
| External radius of the thrust washer   | $R$       | mm               |
| Internal radius of the thrust washer   | $r$       | mm               |

### Metric Conversion Chart

|                                | Multiply by |                                                  |
|--------------------------------|-------------|--------------------------------------------------|
| Inch [in]                      | 25.4        | Millimeters [ mm ]                               |
| Pounds/force [ lbf ]           | 4.4482      | Newton [ n ]                                     |
| foot/minute [ ft/min ]         | 0.00508     | Meter / second [ m/s ]                           |
| Pounds per square inch [ psi ] | 0.006895    | Newton / square millimeter [ N/mm <sup>2</sup> ] |

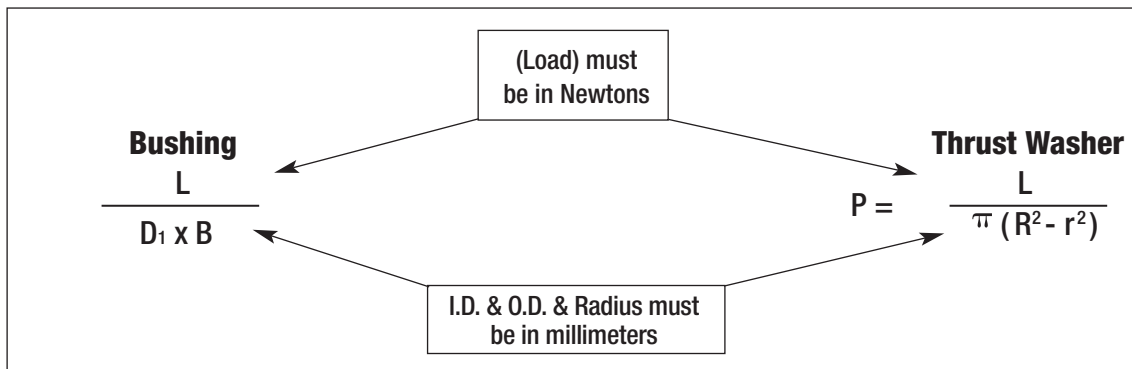
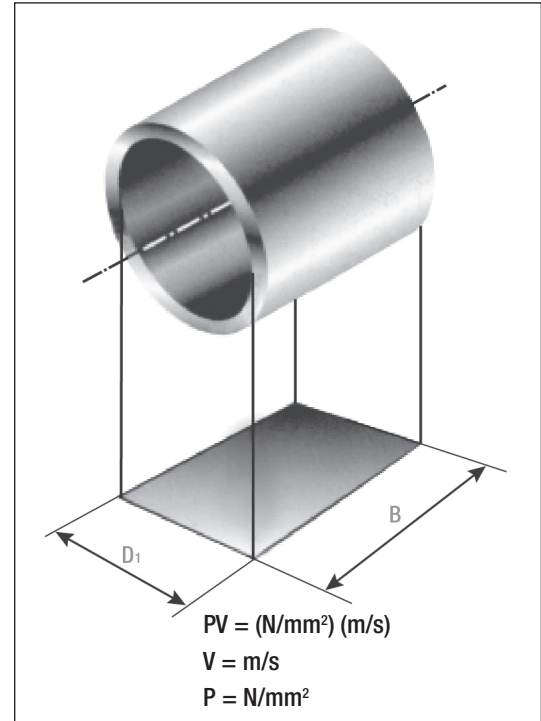

Due to the many different factors involved, the Life formula should only be treated as a rough estimate.

| ROTATION of BEARING                                  | OSCILLATION of BEARING                                                                 |
|------------------------------------------------------|----------------------------------------------------------------------------------------|
| $V = \frac{\pi \times D_1 \times N}{60 \times 10^3}$ | $V = \frac{\pi \times D_1 \times 2\varphi \times N_{osz}}{60 \times 10^3 \times 360}$  |
| ROTATION of WASHER                                   | OSCILLATION of WASHER                                                                  |
| $V = \frac{\pi \times D_5 \times N}{60 \times 10^3}$ | $V = \frac{\pi \times D_5}{60 \times 10^3} \times \frac{2\varphi \times N_{osz}}{360}$ |

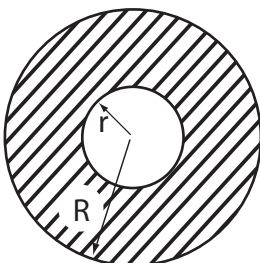

Thrust Washer

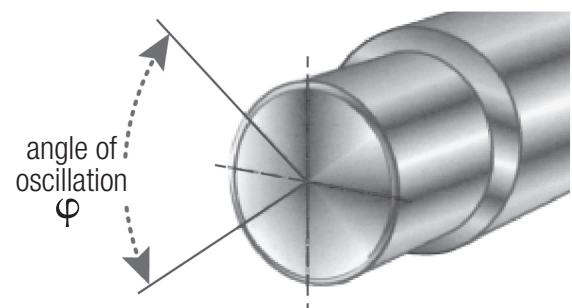

## CALCULATION of the SERVICE LIFE ( $L_h = \text{hours}$ )

The operating life for dry applications of TU™ Self-lubricating bearings is inversely proportional to the load factor (  $p \times v$  ) but, in order to achieve a close approximation of the figure, the following corrective factors must be introduced:

- $K_a$  = constant relative to the type of application;
- $f_p$  = load correction factor;
- $f_c$  = application characteristics and temperature
- $f_d$  = correction factor;
- $f_m$  = bearing size correction factor;  
shaft material correction factor.

$$L_h = \frac{K_a}{pv^{1.2}} \times f_p \times f_c \times f_d \times f_m$$

| $f_p$ = load correction factor     |       |       |       |       |
|------------------------------------|-------|-------|-------|-------|
| $p = \text{N/mm}^2 \text{ or psi}$ |       |       |       |       |
| N/mm <sup>2</sup>                  | <10   | <25   | <50   | > 60  |
| psi                                | <1450 | <3625 | <7252 | <8702 |
|                                    | 1     | 0.3   | 0.2   | 0.1   |

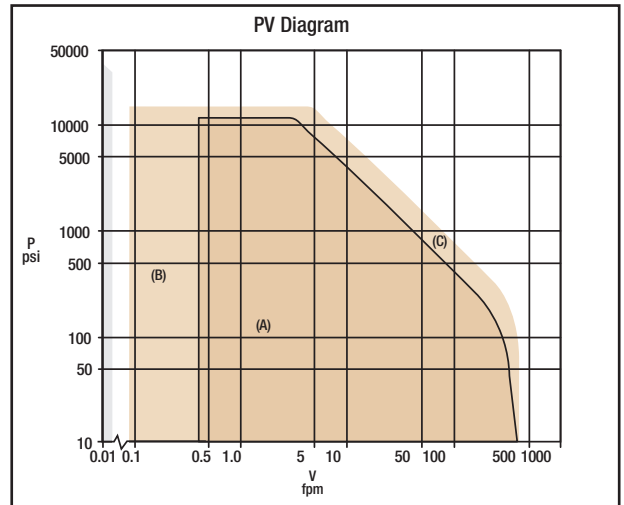

- A. Service life calculation may be used.
- B. Quasi-static: Call before using this Calculation
- C. Requires optimal heat removal.

| $f_c$ = application characteristics and temperature correction factor |                  |                |     |     |     |     |     |
|-----------------------------------------------------------------------|------------------|----------------|-----|-----|-----|-----|-----|
| Characteristics                                                       | Heat Dissipation | Temperature °C |     |     |     |     |     |
|                                                                       |                  | 20             | 60  | 100 | 150 | 200 | 280 |
| Continuous Dry Operation                                              | Good             | 1.0            | 0.8 | 0.6 | 0.4 | 0.2 | 0.1 |
| Continuous Dry Operation                                              | Poor             | 0.5            | 0.4 | 0.3 | 0.2 | 0.1 | -   |
| Intermittent Operation<br>Interval > 10 x Operating Time              | Good             | 2.0            | 1.6 | 1.2 | 0.8 | 0.4 | 0.2 |
| Constant Immersion in Water                                           |                  | 2.0            | 1.6 | 0.8 | -   | -   | -   |
| Alternating Immersion in Water                                        |                  | 0.4            | 0.2 | 0.1 | -   | -   | -   |
| Constant Immersion in Lubricant                                       |                  | 3.0            | 2.4 | 1.8 | 1.2 | 0.8 | -   |

| $f_m$ = shaft material correction factor |       |
|------------------------------------------|-------|
| Material                                 | $f_m$ |
| Low carbon steel                         | 1     |
| Hardened steel                           | 1.5   |
| Stainless Steel                          | 2     |
| Cast iron (0.4 RQ)                       | 1     |
| Aluminum                                 | 0.4   |
| Bronze                                   | 0.4   |
| Plating                                  |       |
|                                          | $f_m$ |
| Zinc Cadmium                             | 0.2   |
| Nickel                                   | 0.2   |
| Chrome                                   | 2     |
| Anodized aluminum                        | 2     |

| $K_a$ = constant relative to the type of application |               |             |
|------------------------------------------------------|---------------|-------------|
| UNIDIRECTIONAL LOAD                                  | ROTATING LOAD | THRUST LOAD |
|                                                      |               |             |
| 400                                                  | 800           | 250         |

| $f_d$ = bearing size correction factor |      |       |       |       |       |
|----------------------------------------|------|-------|-------|-------|-------|
| Shaft diameter (mm)                    |      |       |       |       |       |
| (mm)                                   | ≤ 20 | ≤ 40  | ≤ 100 | ≤ 150 | > 150 |
| (inch)                                 | < .8 | < 1.6 | < 3.9 | < 5.9 | > 5.9 |
|                                        | 1.0  | 0.9   | 0.7   | 0.5   | 0.4   |



## TU™ SLEEVE BEARINGS (Inch Sizes)

| Nominal Bearing Bore | Recommended      |                  | Installed Bearing I.D. | Length ± .010" | Item Number | Part Number |
|----------------------|------------------|------------------|------------------------|----------------|-------------|-------------|
|                      | Shaft Dia.       | Housing Bore     |                        |                |             |             |
| 1/8                  | .1243            | .1878            | .1268                  | 1/8            | 501001      | 02TU02      |
|                      | .1236            | .1873            | .1243                  | 3/16           | 501002      | 02TU03      |
| 5/32                 | .1554            | .2191            | .1581                  | 5/32           | 501003      | 025TU025    |
|                      | .1547            | .2186            | .1556                  | 1/4            | 501004      | 025TU04     |
| 3/16                 | .1865<br>.1858   | .2503<br>.2497   | .1893                  | 3/16           | 501005      | 03TU03      |
|                      |                  |                  | .1867                  | 1/4            | 501006      | 03TU04      |
|                      |                  |                  |                        | 3/8            | 501007      | 03TU06      |
| 1/4                  | .2490<br>.2481   | .3128<br>.3122   | .2518                  | 1/4            | 501008      | 04TU04      |
|                      |                  |                  | .2492                  | 3/8            | 501009      | 04TU06      |
| 5/16                 | .3115<br>.3106   | .3753<br>.3747   | .3143                  | 3/8            | 501010      | 05TU06      |
|                      |                  |                  | .3117                  | 1/2            | 501011      | 05TU08      |
| 3/8                  | .3740<br>.3731   | .4691<br>.4684   | .3769                  | 3/16           | 501012      | 06TU03      |
|                      |                  |                  | .3742                  | 1/4            | 501013      | 06TU04      |
|                      |                  |                  |                        | 3/8            | 501014      | 06TU06      |
|                      |                  |                  |                        | 1/2            | 501015      | 06TU08      |
|                      |                  |                  |                        | 5/8            | 501016      | 06TU10      |
|                      |                  |                  |                        | 3/4            | 501017      | 06TU12      |
| 7/16                 | .4365<br>.4355   | .5316<br>.5309   | .4394                  | 1/2            | 501018      | 07TU08      |
|                      |                  |                  | .4367                  | 3/4            | 501019      | 07TU12      |
| 1/2                  | .4990<br>.4980   | .5941<br>.5934   | .5019                  | 1/4            | 501020      | 08TU04      |
|                      |                  |                  | .4992                  | 3/8            | 501021      | 08TU06      |
|                      |                  |                  |                        | 1/2            | 501022      | 08TU08      |
|                      |                  |                  |                        | 5/8            | 501023      | 08TU10      |
|                      |                  |                  |                        | 3/4            | 501024      | 08TU12      |
|                      |                  |                  |                        | 7/8            | 501025      | 08TU14      |
| 9/16                 | .5615<br>.5605   | .6566<br>.6559   | .5644                  | 3/8            | 501026      | 09TU06      |
|                      |                  |                  | .5617                  | 1/2            | 501027      | 09TU08      |
|                      |                  |                  |                        | 5/8            | 501028      | 09TU10      |
|                      |                  |                  |                        | 3/4            | 501029      | 09TU12      |
| 5/8                  | .6240<br>.6230   | .7192<br>.7184   | .6270                  | 1/4            | 501030      | 10TU04      |
|                      |                  |                  | .6242                  | 1/2            | 501031      | 10TU08      |
|                      |                  |                  |                        | 5/8            | 501032      | 10TU10      |
|                      |                  |                  |                        | 3/4            | 501033      | 10TU12      |
|                      |                  |                  |                        | 7/8            | 501034      | 10TU14      |
|                      |                  |                  |                        | 1              | 501035      | 10TU16      |
| 11/16                | .6865<br>.6855   | .7817<br>.7809   | .6895                  | 7/8            | 501036      | 11TU14      |
|                      |                  |                  | .6867                  |                |             |             |
| 3/4                  | .7491<br>.7479   | .8755<br>.8747   | .7525                  | 1/4            | 501037      | 12TU04      |
|                      |                  |                  | .7493                  | 3/8            | 501038      | 12TU06      |
|                      |                  |                  |                        | 1/2            | 501039      | 12TU08      |
|                      |                  |                  |                        | 5/8            | 501040      | 12TU10      |
|                      |                  |                  |                        | 3/4            | 501041      | 12TU12      |
|                      |                  |                  |                        | 1              | 501042      | 12TU16      |
| 13/16                | .8116<br>.8104   | .9380<br>.9372   | .8150                  | 3/4            | 501043      | 13TU12      |
|                      |                  |                  | .8118                  | 1-1/8          | 501044      | 13TU18      |
| 7/8                  | .8741<br>.8729   | 1.0005<br>.9997  | .8775                  | 1/4            | 501045      | 14TU04      |
|                      |                  |                  | .8743                  | 3/8            | 501046      | 14TU06      |
|                      |                  |                  |                        | 3/4            | 501047      | 14TU12      |
|                      |                  |                  |                        | 7/8            | 501048      | 14TU14      |
|                      |                  |                  |                        | 1              | 501049      | 14TU16      |
|                      |                  |                  |                        | 1-1/4          | 501050      | 14TU20      |
| 1                    | .9991<br>.9979   | 1.1255<br>1.1247 | 1.0025                 | 3/8            | 501051      | 16TU06      |
|                      |                  |                  | .9993                  | 1/2            | 501052      | 16TU08      |
|                      |                  |                  |                        | 3/4            | 501053      | 16TU12      |
|                      |                  |                  |                        | 1              | 501054      | 16TU16      |
|                      |                  |                  |                        | 1-1/4          | 501055      | 16TU20      |
|                      |                  |                  |                        | 1-1/2          | 501056      | 16TU24      |
| 1-1/8                | 1.1238<br>1.1266 | 1.2818<br>1.2808 | 1.1278                 | 3/8            | 501057      | 18TU06      |
|                      |                  |                  | 1.1240                 | 5/8            | 501058      | 18TU10      |
|                      |                  |                  |                        | 3/4            | 501059      | 18TU12      |
|                      |                  |                  |                        | 1              | 501060      | 18TU16      |
| 1-1/4                | 1.2488<br>1.2472 | 1.4068<br>1.4058 | 1.2528                 | 3/8            | 501061      | 20TU06      |
|                      |                  |                  | 1.2490                 | 3/4            | 501062      | 20TU12      |
|                      |                  |                  |                        | 7/8            | 501063      | 20TU14      |
|                      |                  |                  |                        | 1              | 501064      | 20TU16      |
|                      |                  |                  |                        | 1-1/4          | 501065      | 20TU20      |
|                      |                  |                  |                        | 1-3/4          | 501066      | 20TU28      |

| Nominal Bearing Bore | Recommended      |                  | Installed Bearing I.D. | Length ± .010" | Item Number | Part Number |
|----------------------|------------------|------------------|------------------------|----------------|-------------|-------------|
|                      | Shaft Dia.       | Housing Bore     |                        |                |             |             |
| 1-3/8                | 1.3738<br>1.3722 | 1.5318<br>1.5308 | 1.3778                 | 3/4            | 501067      | 22TU12      |
|                      |                  |                  | 1.3740                 | 1              | 501068      | 22TU16      |
|                      |                  |                  |                        | 1-3/8          | 501069      | 22TU22      |
|                      |                  |                  |                        | 1-1/2          | 501070      | 22TU24      |
|                      |                  |                  |                        | 1-3/4          | 501071      | 22TU28      |
| 1-1/2                | 1.4988<br>1.4972 | 1.6568<br>1.6558 | 1.5028                 | 1/2            | 501072      | 24TU08      |
|                      |                  |                  | 1.4990                 | 1              | 501073      | 24TU16      |
|                      |                  |                  |                        | 1-1/8          | 501074      | 24TU18      |
|                      |                  |                  |                        | 1-1/4          | 501075      | 24TU20      |
|                      |                  |                  |                        | 1-1/2          | 501076      | 24TU24      |
|                      |                  |                  |                        | 2              | 501077      | 24TU32      |
| 1-5/8                | 1.6238<br>1.6222 | 1.7818<br>1.7808 | 1.6278                 | 1              | 501078      | 26TU16      |
|                      |                  |                  | 1.6240                 | 1-1/2          | 501079      | 26TU24      |
| 1-3/4                | 1.7487<br>1.7471 | 1.9381<br>1.9371 | 1.7535                 | 1              | 501080      | 28TU16      |
|                      |                  |                  | 1.7489                 | 1-1/2          | 501081      | 28TU24      |
|                      |                  |                  |                        | 1-3/4          | 501082      | 28TU28      |
|                      |                  |                  |                        | 2              | 501083      | 28TU32      |
| 1-7/8                | 1.8737<br>1.8721 | 2.0633<br>2.0621 | 1.8787                 | 3/4            | 501084      | 30TU12      |
|                      |                  |                  | 1.8739                 | 1              | 501085      | 30TU16      |
|                      |                  |                  |                        | 1-7/8          | 501086      | 30TU30      |
|                      |                  |                  |                        | 2-1/4          | 501087      | 30TU36      |
| 2                    | 1.9987<br>1.9969 | 2.1883<br>2.1871 | 2.0037                 | 1/2            | 501088      | 32TU08      |
|                      |                  |                  | 1.9989                 | 1              | 501089      | 32TU16      |
|                      |                  |                  |                        | 1-1/2          | 501090      | 32TU24      |
|                      |                  |                  |                        | 1-3/4          | 501091      | 32TU28      |
|                      |                  |                  |                        | 2              | 501092      | 32TU32      |
|                      |                  |                  |                        | 2-1/2          | 501093      | 32TU40      |
| 2 1/8                | 2.1257<br>2.1239 | 2.3130<br>2.3118 | 2.1326                 | 3              | 501094      | 34TU48      |
|                      |                  |                  | 2.1262                 |                |             |             |
| 2 1/4                | 2.2507<br>2.2489 | 2.4377<br>2.4365 | 2.2573                 | 1 3/4          | 501095      | 36TU28      |
|                      |                  |                  | 2.2509                 | 2              | 501096      | 36TU32      |
|                      |                  |                  |                        | 2 1/4          | 501097      | 36TU36      |
|                      |                  |                  |                        | 2 1/2          | 501098      | 36TU40      |
|                      |                  |                  |                        | 3              | 501099      | 36TU48      |
| 2 1/2                | 2.5011<br>2.4993 | 2.6881<br>2.6869 | 2.5077                 | 1              | 501104      | 40TU16      |
|                      |                  |                  | 2.5013                 | 1 5/8          | 501105      | 40TU26      |
|                      |                  |                  |                        | 2              | 501106      | 40TU32      |
|                      |                  |                  |                        | 2 1/2          | 501107      | 40TU40      |
|                      |                  |                  |                        | 3              | 501108      | 40TU48      |
|                      |                  |                  |                        | 3 1/2          | 501109      | 40TU56      |
|                      |                  |                  |                        | 4 3/4          | 501113      | 40TU76      |
| 2 3/4                | 2.7500<br>2.7482 | 2.9370<br>2.9358 | 2.7566                 | 2              | 501114      | 44TU32      |
|                      |                  |                  | 2.7502                 | 2 1/2          | 501116      | 44TU40      |
|                      |                  |                  |                        | 3              | 501117      | 44TU48      |
|                      |                  |                  |                        | 3 1/2          | 501118      | 44TU56      |
|                      |                  |                  |                        | 5              | 501123      | 44TU80      |
| 2 7/8                | 2.8752<br>2.8734 | 3.0623<br>3.0610 | 2.8819                 | 2              | 501124      | 46TU32      |
|                      |                  |                  | 2.8754                 | 2 1/2          | 501126      | 46TU40      |
|                      |                  |                  |                        | 3              | 501127      | 46TU48      |
| 3                    | 3.0000<br>2.9982 | 3.1872<br>3.1858 | 3.0068                 | 2              | 501134      | 48TU32      |
|                      |                  |                  | 3.0002                 | 2 1/4          | 501135      | 48TU36      |
|                      |                  |                  |                        | 2 1/2          | 501136      | 48TU40      |
|                      |                  |                  |                        | 3              | 501137      | 48TU48      |
|                      |                  |                  |                        | 3 3/4          | 501139      | 48TU60      |
|                      |                  |                  |                        | 4 1/2          | 501141      | 48TU72      |
|                      |                  |                  |                        | 5              | 501143      | 48TU80      |
| 3 1/4                | 3.2500<br>3.2480 | 3.4372<br>3.4358 | 3.2568                 | 2              | 501144      | 52TU32      |
|                      |                  |                  | 3.2502                 | 2 3/8          | 501145      | 52TU38      |
|                      |                  |                  |                        | 2 1/2          | 501146      | 52TU40      |
|                      |                  |                  |                        | 3              | 501147      | 52TU48      |
|                      |                  |                  |                        | 3 1/2          | 501148      | 52TU56      |
|                      |                  |                  |                        | 4              | 501150      | 52TU64      |
|                      |                  |                  |                        | 5              | 501153      | 52TU80      |
| 3 1/2                | 3.5000<br>3.4978 | 3.6872<br>3.6858 | 3.5068                 | 2              | 501154      | 56TU32      |
|                      |                  |                  | 3.5002                 | 2 3/8          | 501155      | 56TU38      |
|                      |                  |                  |                        | 2 1/2          | 501156      | 56TU40      |
|                      |                  |                  |                        | 3              | 501157      | 56TU48      |
|                      |                  |                  |                        | 3 1/2          | 501158      | 56TU56      |
|                      |                  |                  |                        | 3 3/4          | 501159      | 56TU60      |



## TU™ SLEEVE BEARINGS (Inch Sizes)

| Nominal Bearing Bore | Recommended |              | Installed Bearing I.D. | Length ± .010" | Item Number | Part Number |
|----------------------|-------------|--------------|------------------------|----------------|-------------|-------------|
|                      | Shaft Dia.  | Housing Bore |                        |                |             |             |
| 3 5/8                | 3.6250      | 3.8122       | 3.6318                 | 2              | 501164      | 58TU32      |
|                      | 3.6228      | 3.8108       | 3.6252                 | 2 1/2          | 501166      | 58TU40      |
|                      |             |              |                        | 3              | 501167      | 58TU48      |
|                      |             |              |                        | 3 3/4          | 501169      | 58TU60      |
| 3 3/4                | 3.7500      | 3.9372       | 3.7568                 | 2              | 501174      | 60TU32      |
|                      | 3.7478      | 3.9358       | 3.7502                 | 2 1/2          | 501176      | 60TU40      |
|                      |             |              |                        | 3              | 501177      | 60TU48      |
|                      |             |              |                        | 3 1/2          | 501178      | 60TU56      |
|                      |             |              |                        | 3 3/4          | 501179      | 60TU60      |
|                      |             |              | 5                      | 501180         | 60TU80      |             |
| 4                    | 4.0000      | 4.1872       | 4.0068                 | 2              | 501184      | 64TU32      |
|                      | 3.9978      | 4.1858       | 4.0002                 | 2 1/4          | 501185      | 64TU36      |
|                      |             |              |                        | 2 1/2          | 501186      | 64TU40      |
|                      |             |              |                        | 3              | 501187      | 64TU48      |
|                      |             |              |                        | 3 1/2          | 501188      | 64TU56      |
|                      |             |              |                        | 3 3/4          | 501189      | 64TU60      |
|                      |             |              | 4                      | 501190         | 64TU64      |             |
|                      |             |              | 4 3/4                  | 501192         | 64TU76      |             |
| 4 1/4                | 4.2500      | 4.4373       | 4.2568                 | 2              | 501194      | 68TU32      |
|                      | 4.2478      | 4.4358       | 4.2502                 | 3              | 501197      | 68TU48      |
|                      |             |              |                        | 3 1/2          | 501198      | 68TU56      |
|                      |             |              |                        | 4              | 501200      | 68TU64      |
| 4 3/8                | 4.3750      | 4.5622       | 4.3818                 | 2              | 501204      | 70TU32      |
|                      | 4.3728      | 4.5608       | 4.3752                 | 2 1/4          | 501205      | 70TU36      |
|                      |             |              |                        | 3              | 501207      | 70TU48      |
|                      |             |              |                        | 4              | 501210      | 70TU64      |
| 4 1/2                | 4.5000      | 4.6872       | 4.5068                 | 2              | 501214      | 72TU32      |
|                      | 4.4978      | 4.6858       | 4.5002                 | 3              | 501217      | 72TU48      |
|                      |             |              |                        | 3 1/2          | 501218      | 72TU56      |
|                      |             |              |                        | 4              | 501220      | 72TU64      |
|                      |             |              |                        | 4 1/2          | 501221      | 72TU72      |
|                      |             |              |                        | 4 3/4          | 501222      | 72TU76      |
| 4 3/4                | 4.7500      | 4.9374       | 4.7572                 | 2              | 501224      | 76TU32      |
|                      | 4.7475      | 4.9358       | 4.7502                 | 3 1/2          | 501228      | 76TU56      |
|                      |             |              |                        | 4              | 501230      | 76TU64      |
|                      |             |              |                        | 4 3/4          | 501232      | 76TU76      |
| 5                    | 4.9986      | 5.1860       | 5.0056                 | 2              | 501234      | 80TU32      |
|                      | 4.9961      | 5.1844       | 4.9988                 | 2 1/2          | 501236      | 80TU40      |
|                      |             |              |                        | 3              | 501237      | 80TU48      |
|                      |             |              |                        | 3 1/2          | 501238      | 80TU56      |
|                      |             |              |                        | 3 3/4          | 501239      | 80TU60      |
|                      |             |              | 5                      | 501243         | 80TU80      |             |
| 5 1/4                | 5.2500      | 5.4374       | 5.2570                 | 2              | 501244      | 84TU32      |
|                      | 5.2475      | 5.4358       | 5.2502                 | 3              | 501247      | 84TU48      |
|                      |             |              |                        | 3 3/4          | 501249      | 84TU60      |
|                      |             |              |                        | 4 1/2          | 501251      | 84TU72      |
| 5 1/2                | 5.5000      | 5.6874       | 5.5070                 | 2              | 501254      | 88TU32      |
|                      | 4.4975      | 5.6858       | 5.5002                 | 3              | 501257      | 88TU48      |
|                      |             |              |                        | 3 3/4          | 501259      | 88TU60      |
|                      |             |              |                        | 4              | 501260      | 88TU64      |
|                      |             |              |                        | 4 1/2          | 501261      | 88TU72      |
| 5 3/4                | 5.7500      | 5.9374       | 5.7570                 | 2              | 501264      | 92TU32      |
|                      | 5.7475      | 5.9358       | 5.7502                 | 3              | 501267      | 92TU48      |
|                      |             |              |                        | 4              | 501270      | 92TU64      |
|                      |             |              |                        | 5              | 501273      | 92TU80      |
| 6                    | 6.0000      | 6.1874       | 6.0070                 | 2              | 501274      | 96TU32      |
|                      | 5.9975      | 6.1858       | 6.0002                 | 3              | 501277      | 96TU48      |
|                      |             |              |                        | 3 1/2          | 501278      | 96TU56      |
|                      |             |              |                        | 3 3/4          | 501279      | 96TU60      |
|                      |             |              |                        | 4              | 501280      | 96TU64      |
| 6 1/4                | 6.2500      | 6.4374       | 6.2570                 | 2              | 501284      | 100TU32     |
|                      | 6.2475      | 6.4358       | 6.2502                 | 3              | 501287      | 100TU48     |
|                      |             |              |                        | 4              | 501290      | 100TU64     |
|                      |             |              |                        | 4 1/2          | 501291      | 100TU72     |
|                      |             |              |                        | 5              | 501293      | 100TU80     |
| 6 1/2                | 6.5000      | 6.6874       | 6.5070                 | 3              | 501297      | 104TU48     |
|                      | 6.4975      | 6.6858       | 6.5002                 | 3 1/2          | 501298      | 104TU56     |
|                      |             |              |                        | 4              | 501300      | 104TU64     |
|                      |             |              |                        | 5              | 501303      | 104TU80     |

| Nominal Bearing Bore | Recommended |              | Installed Bearing I.D. | Length ± .010" | Item Number | Part Number |
|----------------------|-------------|--------------|------------------------|----------------|-------------|-------------|
|                      | Shaft Dia.  | Housing Bore |                        |                |             |             |
| 6 3/4                | 6.7500      | 6.9374       | 6.7570                 | 3              | 501307      | 108TU48     |
|                      | 6.7475      | 6.9358       | 6.7502                 | 3 1/2          | 501308      | 108TU56     |
|                      |             |              |                        | 4              | 501310      | 108TU64     |
|                      |             |              |                        | 5              | 501313      | 108TU80     |
| 7                    | 6.9954      | 7.1830       | 7.0026                 | 3              | 501317      | 112TU48     |
|                      | 6.9929      | 7.1812       | 6.9956                 | 3 3/4          | 501319      | 112TU60     |
|                      |             |              |                        | 4              | 501320      | 112TU64     |
|                      |             |              |                        | 5              | 501323      | 112TU80     |

## TU™ FLANGE BEARINGS (Inch Sizes)

| Nominal Bearing Bore I.D. | Recommended |              | Installed Bearing I.D. | Nominal Flange O.D. ± .020" | Flange Thick. | Length ± .010" | Item Number | Part Number |
|---------------------------|-------------|--------------|------------------------|-----------------------------|---------------|----------------|-------------|-------------|
|                           | Shaft Dia.  | Housing Bore |                        |                             |               |                |             |             |
| 3/8                       | 0.3740      | 0.4691       | 0.3769                 | 11/16                       | .052          | 1/4            | 502001      | 06FTU04     |
|                           | 0.3731      | 0.4684       | 0.3742                 |                             | .044          | 3/8            | 502002      | 06FTU06     |
|                           |             |              |                        |                             |               | 1/2            | 502003      | 06FTU08     |
|                           |             |              |                        |                             |               | 3/4            | 502004      | 06FTU12     |
| 1/2                       | 0.4990      | 0.5941       | 0.5019                 | 13/16                       | .052          | 1/4            | 502005      | 08FTU04     |
|                           | 0.4980      | 0.5934       | 0.4992                 |                             | .044          | 3/8            | 502006      | 08FTU06     |
|                           |             |              |                        |                             |               | 1/2            | 502007      | 08FTU08     |
|                           |             |              |                        |                             |               | 3/4            | 502008      | 08FTU12     |
| 5/8                       | 0.6240      | 0.7192       | 0.6270                 | 15/16                       | .052          | 3/8            | 502009      | 10FTU06     |
|                           | 0.6230      | 0.7184       | 0.6242                 |                             | .044          | 1/2            | 502010      | 10FTU08     |
|                           |             |              |                        |                             |               | 5/8            | 502011      | 10FTU10     |
|                           |             |              |                        |                             |               | 3/4            | 502012      | 10FTU12     |
| 3/4                       | 0.7491      | 0.8755       | 0.7525                 | 1 1/8                       | .068          | 3/8            | 502013      | 12FTU06     |
|                           | 0.7479      | 0.8747       | 0.7493                 |                             | .060          | 1/2            | 502014      | 12FTU08     |
|                           |             |              |                        |                             |               | 3/4            | 502015      | 12FTU12     |
|                           |             |              |                        |                             |               | 1              | 502016      | 12FTU16     |
| 7/8                       | 0.8741      | 1.0005       | 0.8775                 | 1 1/4                       | .068          | 1/2            | 502017      | 14FTU08     |
|                           | 0.8729      | 0.9997       | 0.8743                 |                             | .060          | 3/4            | 502018      | 14FTU12     |
|                           |             |              |                        |                             |               | 1              | 502019      | 14FTU16     |
|                           |             |              |                        |                             |               | 1 1/4          | 502020      | 14FTU20     |
| 1                         | 0.9991      | 1.1256       | 1.0026                 | 1 3/8                       | .068          | 1/2            | 502021      | 16FTU08     |
|                           | 0.9979      | 1.1246       | 0.9992                 |                             | .060          | 3/4            | 502022      | 16FTU12     |
|                           |             |              |                        |                             |               | 1              | 502023      | 16FTU16     |
|                           |             |              |                        |                             |               | 1 1/4          | 502024      | 16FTU20     |
| 1 1/4                     | 1.2488      | 1.4068       | 1.2528                 | 1 3/4                       | .083          | 1              | 502025      | 20FTU16     |
|                           | 1.2472      | 1.4058       | 1.2490                 |                             | .075          | 1 1/4          | 502026      | 20FTU20     |
|                           |             |              |                        |                             |               | 1 1/2          | 502027      | 20FTU24     |
| 1 1/2                     | 1.4988      | 1.6568       | 1.5028                 | 2                           | .083          | 1              | 502028      | 24FTU16     |
|                           | 1.4972      | 1.6558       | 1.4990                 |                             | .075          | 1 1/2          | 502029      | 24FTU24     |
|                           |             |              |                        |                             |               | 2              | 502030      | 24FTU32     |
| 1 3/4                     | 1.7487      | 1.9381       | 1.7535                 | 2 3/8                       | .098          | 1              | 502031      | 28FTU16     |
|                           | 1.7471      | 1.9371       | 1.7489                 |                             | .090          | 1 1/2          | 502032      | 28FTU24     |
|                           |             |              |                        |                             |               | 2              | 502033      | 28FTU32     |

Chamfers: Standard flanged TU Bearings are supplied with 15°/20° chamfers  
\*Other sizes are available on special orders

**For TU™ Washers in Inch Sizes refer to page 58**







## TU™ SLEEVE BEARINGS (Metric Sizes)

| Nominal Bearing Bore | Recommended |              | Installed Bearing I.D. | Length ± .25mm | Item Number | Part Number |
|----------------------|-------------|--------------|------------------------|----------------|-------------|-------------|
|                      | Shaft Dia.  | Housing Bore |                        |                |             |             |
| 2                    | 2.000       | 3.508        | 2.048                  | 3              | 701001      | M0203TU     |
|                      | 1.994       | 3.500        | 2.000                  | 5              | 701002      | M0205TU     |
| 3                    | 3.000       | 4.508        | 3.048                  | 3              | 701003      | M0303TU     |
|                      | 2.994       | 4.500        | 3.000                  | 4              | 701004      | M0304TU     |
|                      |             |              |                        | 5              | 701005      | M0305TU     |
|                      |             |              |                        | 6              | 701006      | M0306TU     |
| 4                    | 4.000       | 5.508        | 4.048                  | 3              | 701007      | M0403TU     |
|                      | 3.992       | 5.500        | 4.000                  | 4              | 701008      | M0404TU     |
|                      |             |              |                        | 6              | 701009      | M0406TU     |
|                      |             |              |                        | 10             | 701010      | M0410TU     |
| 5                    | 4.990       | 7.015        | 5.055                  | 5              | 701011      | M0505TU     |
|                      | 4.978       | 7.000        | 4.990                  | 8              | 701012      | M0508TU     |
|                      |             |              |                        | 10             | 701013      | M0510TU     |
| 6                    | 5.990       | 8.015        | 6.055                  | 6              | 701015      | M0606TU     |
|                      | 5.978       | 8.000        | 5.990                  | 8              | 701016      | M0608TU     |
|                      |             |              |                        | 10             | 701017      | M0610TU     |
| 7                    | 6.987       | 9.015        | 7.055                  | 10             | 701018      | M0710TU     |
|                      | 6.972       | 9.000        | 6.990                  |                |             |             |
| 8                    | 7.987       | 10.015       | 8.055                  | 8              | 701020      | M0808TU     |
|                      | 7.972       | 10.000       | 7.990                  | 10             | 701021      | M0810TU     |
|                      |             |              |                        | 12             | 701022      | M0812TU     |
| 10                   | 9.987       | 12.018       | 10.058                 | 8              | 701023      | M1008TU     |
|                      | 9.972       | 12.000       | 9.990                  | 10             | 701024      | M1010TU     |
|                      |             |              |                        | 12             | 701025      | M1012TU     |
|                      |             |              |                        | 15             | 701026      | M1015TU     |
|                      |             |              | 20                     | 701027         | M1020TU     |             |
| 12                   | 11.984      | 14.018       | 12.058                 | 8              | 701028      | M1208TU     |
|                      | 11.966      | 14.000       | 11.990                 | 10             | 701029      | M1210TU     |
|                      |             |              |                        | 12             | 701030      | M1212TU     |
|                      |             |              |                        | 15             | 701031      | M1215TU     |
|                      |             |              |                        | 20             | 701032      | M1220TU     |
|                      |             |              | 25                     | 701033         | M1225TU     |             |
| 13                   | 12.984      | 15.018       | 13.058                 | 10             | 701034      | M1310TU     |
|                      | 12.966      | 15.000       | 12.990                 | 20             | 701035      | M1320TU     |
| 14                   | 13.984      | 16.018       | 14.058                 | 10             | 701037      | M1410TU     |
|                      | 13.966      | 16.000       | 13.990                 | 12             | 701038      | M1412TU     |
|                      |             |              |                        | 15             | 701039      | M1415TU     |
|                      |             |              |                        | 20             | 701040      | M1420TU     |
|                      |             |              | 25                     | 701041         | M1425TU     |             |
| 15                   | 14.984      | 17.018       | 15.058                 | 10             | 701042      | M1510TU     |
|                      | 14.966      | 17.000       | 14.990                 | 12             | 701043      | M1512TU     |
|                      |             |              |                        | 15             | 701044      | M1515TU     |
|                      |             |              |                        | 20             | 701045      | M1520TU     |
|                      |             |              |                        | 25             | 701046      | M1525TU     |
| 16                   | 15.984      | 18.018       | 16.058                 | 10             | 701047      | M1610TU     |
|                      | 15.966      | 18.000       | 15.990                 | 12             | 701048      | M1612TU     |
|                      |             |              |                        | 15             | 701049      | M1615TU     |
|                      |             |              |                        | 20             | 701050      | M1620TU     |
|                      |             |              | 25                     | 701051         | M1625TU     |             |
| 17                   | 16.984      | 19.021       | 17.061                 | 15             | 701052      | M1715TU     |
|                      | 16.966      | 19.000       | 16.990                 | 20             | 701053      | M1720TU     |
| 18                   | 17.984      | 20.021       | 18.061                 | 15             | 701055      | M1815TU     |
|                      | 17.966      | 20.000       | 17.990                 | 20             | 701056      | M1820TU     |
|                      |             |              |                        | 25             | 701057      | M1825TU     |
| 20                   | 19.980      | 23.021       | 20.062                 | 10             | 701061      | M2010TU     |
|                      | 19.959      | 23.000       | 19.990                 | 15             | 701062      | M2015TU     |
|                      |             |              |                        | 20             | 701063      | M2020TU     |
|                      |             |              |                        | 25             | 701064      | M2025TU     |
|                      |             |              |                        | 30             | 701065      | M2030TU     |
| 22                   | 21.980      | 25.021       | 22.071                 | 15             | 701066      | M2215TU     |
|                      | 21.959      | 25.000       | 21.990                 | 20             | 701067      | M2220TU     |
|                      |             |              |                        | 25             | 701068      | M2225TU     |
|                      |             |              |                        | 30             | 701069      | M2230TU     |
| 24                   | 23.980      | 27.021       | 24.071                 | 15             | 701070      | M2415TU     |
|                      | 23.959      | 27.000       | 23.990                 | 20             | 701071      | M2420TU     |
|                      |             |              |                        | 25             | 701072      | M2425TU     |
|                      |             |              |                        | 30             | 701073      | M2430TU     |

| Nominal Bearing Bore | Recommended |              | Installed Bearing I.D. | Length ± .25mm | Item Number | Part Number |
|----------------------|-------------|--------------|------------------------|----------------|-------------|-------------|
|                      | Shaft Dia.  | Housing Bore |                        |                |             |             |
| 25                   | 24.980      | 28.021       | 25.071                 | 12             | 701078      | M2512TU     |
|                      | 24.959      | 28.000       | 24.990                 | 15             | 701079      | M2515TU     |
|                      |             |              |                        | 20             | 701080      | M2520TU     |
|                      |             |              |                        | 25             | 701081      | M2525TU     |
|                      |             |              |                        | 30             | 701082      | M2530TU     |
|                      |             |              | 50                     | 701083         | M2550TU     |             |
| 28                   | 27.980      | 32.025       | 28.085                 | 15             | 701084      | M2815TU     |
|                      | 27.959      | 32.000       | 27.990                 | 20             | 701085      | M2820TU     |
|                      |             |              |                        | 25             | 701086      | M2825TU     |
|                      |             |              |                        | 30             | 701087      | M2830TU     |
| 30                   | 29.980      | 34.025       | 30.085                 | 15             | 701089      | M3015TU     |
|                      | 29.959      | 34.000       | 29.990                 | 20             | 701090      | M3020TU     |
|                      |             |              |                        | 25             | 701091      | M3025TU     |
|                      |             |              |                        | 30             | 701092      | M3030TU     |
|                      |             |              | 40                     | 701093         | M3040TU     |             |
| 32                   | 31.975      | 36.025       | 32.085                 | 20             | 701094      | M3220TU     |
|                      | 31.950      | 36.000       | 31.990                 | 30             | 701095      | M3230TU     |
|                      |             |              |                        | 40             | 701096      | M3240TU     |
| 35                   | 34.975      | 39.025       | 35.085                 | 20             | 701097      | M3520TU     |
|                      | 34.950      | 39.000       | 34.990                 | 30             | 701098      | M3530TU     |
|                      |             |              |                        | 35             | 701099      | M3535TU     |
|                      |             |              |                        | 40             | 701100      | M3540TU     |
|                      |             |              | 50                     | 701101         | M3550TU     |             |
| 40                   | 39.975      | 44.025       | 40.085                 | 20             | 701103      | M4020TU     |
|                      | 39.950      | 44.000       | 39.990                 | 30             | 701104      | M4030TU     |
|                      |             |              |                        | 40             | 701105      | M4040TU     |
|                      |             |              |                        | 50             | 701107      | M4050TU     |
| 45                   | 44.975      | 50.025       | 45.105                 | 20             | 701108      | M4520TU     |
|                      | 44.950      | 50.000       | 44.990                 | 30             | 701109      | M4530TU     |
|                      |             |              |                        | 40             | 701110      | M4540TU     |
|                      |             |              |                        | 45             | 701111      | M4545TU     |
|                      |             |              |                        | 50             | 701112      | M4550TU     |
| 50                   | 49.975      | 55.530       | 50.110                 | 20             | 701113      | M5020TU     |
|                      | 49.950      | 55.000       | 49.990                 | 30             | 701115      | M5030TU     |
|                      |             |              |                        | 40             | 701116      | M5040TU     |
|                      |             |              |                        | 50             | 701117      | M5050TU     |
|                      |             |              | 60                     | 701118         | M5060TU     |             |
| 55                   | 54.970      | 60.030       | 55.110                 | 20             | 701119      | M5520TU     |
|                      | 54.940      | 60.000       | 54.990                 | 25             | 701120      | M5525TU     |
|                      |             |              |                        | 30             | 701121      | M5530TU     |
|                      |             |              |                        | 40             | 701122      | M5540TU     |
|                      |             |              |                        | 50             | 701123      | M5550TU     |
|                      |             |              | 55                     | 701124         | M5555TU     |             |
|                      |             |              | 60                     | 701125         | M5560TU     |             |
| 60                   | 59.970      | 65.030       | 60.110                 | 30             | 701127      | M6030TU     |
|                      | 59.940      | 65.000       | 59.990                 | 40             | 701128      | M6040TU     |
|                      |             |              |                        | 60             | 701130      | M6060TU     |
|                      |             |              |                        | 70             | 701131      | M6070TU     |
| 65                   | 64.970      | 70.030       | 65.110                 | 30             | 701132      | M6530TU     |
|                      | 64.940      | 70.000       | 64.990                 | 50             | 701134      | M6550TU     |
|                      |             |              |                        | 70             | 701135      | M6570TU     |
| 70                   | 69.970      | 75.030       | 70.110                 | 40             | 701136      | M7040TU     |
|                      | 69.940      | 75.000       | 69.990                 | 50             | 701137      | M7050TU     |
|                      |             |              |                        | 60             | 701138      | M7060TU     |
|                      |             |              |                        | 70             | 701139      | M7070TU     |
| 75                   | 74.970      | 80.030       | 75.110                 | 40             | 701140      | M7540TU     |
|                      | 74.940      | 80.000       | 74.990                 | 50             | 701141      | M7550TU     |
|                      |             |              |                        | 60             | 701142      | M7560TU     |
|                      |             |              | 80                     | 701144         | M7580TU     |             |
| 80                   | 80.000      | 85.035       | 80.145                 | 60             | 701145      | M8060TU     |
|                      | 79.954      | 85.000       | 80.010                 | 100            | 701147      | M80100TU    |
| 85                   | 85.000      | 90.035       | 85.145                 | 30             | 701148      | M8530TU     |
|                      | 84.946      | 90.000       | 85.010                 | 60             | 701149      | M8560TU     |
|                      |             |              |                        | 100            | 701150      | M85100TU    |
| 90                   | 90.000      | 95.035       | 90.145                 | 60             | 701151      | M9060TU     |
|                      | 89.946      | 95.000       | 90.010                 | 100            | 701152      | M90100TU    |
| 95                   | 95.000      | 100.035      | 95.145                 | 60             | 701153      | M9560TU     |
|                      | 94.946      | 100.000      | 95.010                 | 100            | 701154      | M95100TU    |

\*Other sizes are available on special orders



**TU™ SLEEVE BEARINGS (Metric Sizes)**

| Nominal Bearing Bore | Recommended |              | Installed Bearing I.D. | Length ± .25mm | Item Number | Part Number |
|----------------------|-------------|--------------|------------------------|----------------|-------------|-------------|
|                      | Shaft Dia.  | Housing Bore |                        |                |             |             |
| 100                  | 100.000     | 105.035      | 100.145                | 60             | 701156      | M10060TU    |
|                      | 99.946      | 105.000      | 100.010                | 70             | 701157      | M10070TU    |
|                      |             |              |                        | 80             | 701158      | M10080TU    |
|                      |             |              |                        | 115            | 701160      | M100115TU   |
| 105                  | 105.000     | 110.035      | 105.145                | 60             | 701161      | M10560TU    |
|                      | 104.946     | 110.000      | 105.010                | 115            | 701163      | M105115TU   |
| 110                  | 110.000     | 115.035      | 110.145                | 60             | 701164      | M11060TU    |
|                      | 109.946     | 115.000      | 110.010                | 115            | 701166      | M110115TU   |
| 115                  | 115.000     | 120.035      | 115.145                | 50             | 701167      | M11550TU    |
|                      | 114.946     | 120.000      | 115.010                | 60             | 701168      | M11560TU    |
|                      |             |              |                        | 70             | 701169      | M11570TU    |
| 120                  | 120.000     | 125.040      | 120.220                | 50             | 701171      | M12050TU    |
|                      | 119.946     | 125.000      | 120.048                | 60             | 701172      | M12060TU    |
|                      |             |              |                        | 100            | 701173      | M120100TU   |
| 125                  | 125.000     | 130.040      | 125.220                | 60             | 701174      | M12560TU    |
|                      | 124.937     | 130.000      | 125.048                | 100            | 701175      | M125100TU   |
| 130                  | 130.000     | 135.040      | 130.220                | 60             | 701176      | M13060TU    |
|                      | 129.937     | 135.000      | 130.048                | 100            | 701177      | M130100TU   |
| 135                  | 135.000     | 140.040      | 135.220                | 60             | 701178      | M13560TU    |
|                      | 134.937     | 140.000      | 135.048                | 80             | 701179      | M13580TU    |
|                      |             |              |                        | 100            | 701180      | M135100TU   |
| 140                  | 140.000     | 145.040      | 140.220                | 60             | 701181      | M14060TU    |
|                      | 139.937     | 145.000      | 140.048                | 100            | 701182      | M140100TU   |
| 150                  | 150.000     | 155.040      | 150.220                | 60             | 701185      | M15060TU    |
|                      | 149.937     | 155.000      | 150.048                | 80             | 701186      | M15080TU    |
|                      |             |              |                        | 100            | 701187      | M150100TU   |
| 160                  | 160.000     | 165.040      | 160.220                | 60             | 701190      | M16060TU    |
|                      | 159.937     | 165.000      | 160.048                | 80             | 701191      | M16080TU    |
|                      |             |              |                        | 100            | 701192      | M160100TU   |
| 180                  | 180.000     | 185.046      | 180.220                | 60             | 701199      | M18060TU    |
|                      | 179.937     | 185.000      | 180.048                | 100            | 701201      | M180100TU   |
| 200                  | 200.000     | 205.046      | 200.220                | 60             | 701204      | M20060TU    |
|                      | 199.928     | 205.000      | 200.048                | 100            | 701205      | M200100TU   |
| 220                  | 220.000     | 225.046      | 220.220                | 60             | 701212      | M22060TU    |
|                      | 219.928     | 225.000      | 220.048                | 100            | 701213      | M220100TU   |
| 250                  | 250.000     | 255.052      | 250.220                | 60             | 701218      | M25060TU    |
|                      | 249.928     | 255.000      | 250.048                | 100            | 701219      | M250100TU   |
| 300                  | 300.000     | 305.052      | 300.220                | 60             | 701222      | M30060TU    |
|                      | 299.919     | 305.000      | 300.048                | 100            | 701223      | M300100TU   |

**TU™ FLANGED BEARINGS (Metric Sizes)**

| Nominal Bearing Bore I.D. | Recommended |              | Installed Bearing I.D. | Nominal Flange O.D. ±.05mm | Flange Thick. | Length ±.25mm | Item Number | Part Number |
|---------------------------|-------------|--------------|------------------------|----------------------------|---------------|---------------|-------------|-------------|
|                           | Shaft Dia.  | Housing Bore |                        |                            |               |               |             |             |
| 6                         | 5.990       | 8.015        | 6.055                  | 12                         | 1.00          | 4             | 702001      | FM0604TU    |
|                           | 5.978       | 8.000        | 5.990                  |                            | .80           | 7             | 702002      | FM0607TU    |
|                           |             |              |                        |                            |               | 8             | 702003      | FM0608TU    |
| 8                         | 7.987       | 10.015       | 8.055                  | 15                         | 1.00          | 5.5           | 702004      | FM0805.5TU  |
|                           | 7.972       | 10.000       | 7.990                  |                            | .80           | 7.5           | 702005      | FM0807.5TU  |
|                           |             |              |                        |                            |               | 9.5           | 702006      | FM0809.5TU  |
| 10                        | 9.987       | 12.018       | 10.058                 | 18                         | 1.00          | 7             | 702007      | FM1007TU    |
|                           | 9.972       | 12.000       | 9.990                  |                            | .80           | 9             | 702008      | FM1009TU    |
|                           |             |              |                        |                            |               | 12            | 702009      | FM1012TU    |
| 12                        | 11.984      | 14.018       | 12.058                 | 20                         | 1.00          | 7             | 702011      | FM1207TU    |
|                           | 11.966      | 14.000       | 11.990                 |                            | .80           | 9             | 702012      | FM1209TU    |
|                           |             |              |                        |                            |               | 12            | 702013      | FM1212TU    |
| 14                        | 13.984      | 16.018       | 14.058                 | 22                         | 1.00          | 12            | 702015      | FM1412TU    |
|                           | 13.966      | 16.000       | 13.990                 |                            | .80           | 17            | 702016      | FM1417TU    |
|                           |             |              |                        |                            |               |               |             |             |
| 15                        | 14.984      | 17.018       | 15.058                 | 23                         | 1.00          | 9             | 702017      | FM1509TU    |
|                           | 14.966      | 17.000       | 14.990                 |                            | .80           | 12            | 702018      | FM1512TU    |
|                           |             |              |                        |                            |               | 17            | 702019      | FM1517TU    |
| 16                        | 15.984      | 18.018       | 16.058                 | 24                         | 1.00          | 12            | 702020      | FM1612TU    |
|                           | 15.966      | 18.000       | 15.990                 |                            | .80           | 17            | 702021      | FM1617TU    |
|                           |             |              |                        |                            |               |               |             |             |
| 18                        | 17.984      | 20.021       | 18.061                 | 26                         | 1.00          | 12            | 702022      | FM1812TU    |
|                           | 17.966      | 20.000       | 17.990                 |                            | .80           | 17            | 702023      | FM1817TU    |
|                           |             |              |                        |                            |               | 22            | 702024      | FM1822TU    |
| 20                        | 19.980      | 23.021       | 20.062                 | 30                         | 1.50          | 11.5          | 702025      | FM2011.5TU  |
|                           | 19.959      | 23.000       | 19.990                 |                            | 1.30          | 16.5          | 702026      | FM2016.5TU  |
|                           |             |              |                        |                            |               | 21.5          | 702027      | FM2021.5TU  |
| 25                        | 24.980      | 28.021       | 25.071                 | 35                         | 1.50          | 11.5          | 702028      | FM2511.5TU  |
|                           | 24.959      | 28.000       | 24.990                 |                            | 1.30          | 16.5          | 702029      | FM2516.5TU  |
|                           |             |              |                        |                            |               | 21.5          | 702030      | FM2521.5TU  |
| 30                        | 29.980      | 34.025       | 30.085                 | 42                         | 2.00          | 16            | 702031      | FM3016TU    |
|                           | 29.959      | 34.000       | 29.990                 |                            | 1.80          | 26            | 702032      | FM3026TU    |
| 35                        | 34.975      | 39.025       | 35.085                 | 47                         | 2.00          | 16            | 702033      | FM3516TU    |
|                           | 34.950      | 39.000       | 34.990                 |                            | 1.80          | 26            | 702034      | FM3526TU    |
| 40                        | 39.975      | 44.025       | 40.085                 | 52                         | 2.00          | 16            | 702035      | FM4016TU    |
|                           | 39.950      | 44.000       | 39.990                 |                            | 1.80          | 26            | 702036      | FM4026TU    |

Chamfers: Standard flanged TU Bearings are supplied with 15°/20° chamfers  
\*Other sizes are available on special orders

**For TU™ Washers in Metric Sizes refer to page 58**





## TU™ Washers (Inch Sizes)

| Inside Diameter<br>+.010 | Outside Diameter<br>-.010 | Thickness<br>+.0020 | Dowel Hole        |                           | Housing<br>Recess<br>Depth<br>+.010 | Item<br>Number | Part<br>Number |
|--------------------------|---------------------------|---------------------|-------------------|---------------------------|-------------------------------------|----------------|----------------|
|                          |                           |                     | Diameter<br>+.010 | P.C.<br>Diameter<br>-.010 |                                     |                |                |
| .500                     | .875                      | .061                | .067              | .692                      | .040                                | 502401         | W06TU          |
| .562                     | 1.000                     | .061                | .067              | .786                      | .040                                | 502402         | W07TU          |
| .625                     | 1.125                     | .061                | .099              | .880                      | .040                                | 502403         | W08TU          |
| .687                     | 1.187                     | .061                | .099              | .942                      | .040                                | 502404         | W09TU          |
| .750                     | 1.250                     | .061                | .099              | 1.005                     | .040                                | 502405         | W10TU          |
| .812                     | 1.375                     | .061                | .099              | 1.099                     | .040                                | 502406         | W11TU          |
| .875                     | 1.500                     | .061                | .130              | 1.192                     | .040                                | 503407         | W12TU          |
| .937                     | 1.625                     | .061                | .130              | 1.286                     | .040                                | 502408         | W13TU          |
| 1.000                    | 1.750                     | .061                | .130              | 1.380                     | .040                                | 502409         | W14TU          |
| 1.125                    | 2.000                     | .061                | .161              | 1.567                     | .040                                | 502410         | W16TU          |
| 1.250                    | 2.125                     | .061                | .161              | 1.692                     | .040                                | 502411         | W18TU          |
| 1.375                    | 2.250                     | .061                | .161              | 1.817                     | .040                                | 502412         | W20TU          |
| 1.500                    | 2.500                     | .061                | .192              | 2.005                     | .040                                | 502413         | W22TU          |
| 1.625                    | 2.625                     | .061                | .192              | 2.130                     | .040                                | 502414         | W24TU          |
| 1.750                    | 2.750                     | .061                | .192              | 2.255                     | .040                                | 502415         | W26TU          |
| 2.000                    | 3.000                     | .091                | .192              | 2.505                     | .070                                | 502416         | W28TU          |
| 2.125                    | 3.125                     | .091                | .192              | 2.630                     | .070                                | 502417         | W30TU          |
| 2.250                    | 3.250                     | .091                | .192              | 2.755                     | .070                                | 502418         | W32TU          |

Chamfers: Standard flanged TU Bearings are supplied with 15°/20° chamfers

\*Other sizes are available on special orders

## TU™ Washers (Metric Sizes)

| Inside Diameter<br>+.25mm | Outside Diameter<br>-.25mm | Thickness<br>+.05mm | Dowel Hole         |                            | Housing<br>Recess<br>Depth<br>+.25mm | Item<br>Number | Part<br>Number |
|---------------------------|----------------------------|---------------------|--------------------|----------------------------|--------------------------------------|----------------|----------------|
|                           |                            |                     | Diameter<br>+.25mm | P.C.<br>Diameter<br>-.24mm |                                      |                |                |
| 10.00                     | 20.00                      | 1.45                | —                  | —                          | .95                                  | 702401         | WM08TU         |
| 12.00                     | 24.00                      | 1.45                | 1.620              | 18.12                      | .95                                  | 702402         | WM10TU         |
| 14.00                     | 26.00                      | 1.45                | 2.120              | 20.12                      | .95                                  | 702403         | WM12TU         |
| 16.00                     | 30.00                      | 1.45                | 2.120              | 22.12                      | .95                                  | 702404         | WM14TU         |
| 18.00                     | 32.00                      | 1.45                | 2.120              | 25.12                      | .95                                  | 702405         | WM16TU         |
| 20.00                     | 36.00                      | 1.45                | 3.120              | 28.12                      | .95                                  | 702406         | WM18TU         |
| 22.00                     | 38.00                      | 1.45                | 3.120              | 30.12                      | .95                                  | 702407         | WM20TU         |
| 24.00                     | 42.00                      | 1.45                | 3.120              | 33.12                      | .95                                  | 702408         | WM22TU         |
| 26.00                     | 44.00                      | 1.45                | 3.120              | 35.12                      | .95                                  | 702409         | WM24TU         |
| 28.00                     | 48.00                      | 1.45                | 4.120              | 38.12                      | .95                                  | 702410         | WM25TU         |
| 32.00                     | 54.00                      | 1.45                | 4.120              | 43.12                      | .95                                  | 702411         | WM30TU         |
| 38.00                     | 62.00                      | 1.45                | 4.120              | 50.12                      | .95                                  | 702412         | WM35TU         |
| 42.00                     | 66.00                      | 1.45                | 4.120              | 54.12                      | .95                                  | 702413         | WM40TU         |
| 48.00                     | 74.00                      | 1.95                | 4.120              | 61.12                      | 1.45                                 | 702414         | WM45TU         |
| 52.00                     | 78.00                      | 1.95                | 4.120              | 65.12                      | 1.45                                 | 703415         | WM50TU         |
| 62.00                     | 90.00                      | 1.95                | 4.120              | 76.12                      | 1.45                                 | 702416         | WM60TU         |

**For TU™ Sleeve & Flange Bearings in Inch Sizes refer to pages 54 & 55**



**For TU™ Sleeve & Flange Bearings in Metric Sizes refer to pages 56 & 57**





**TP™ LEAD-FREE STEEL-BACKED PTFE LINED BEARINGS**

**TP™ SLEEVE BEARINGS (Inch Sizes)**

| Nominal Bearing Bore I.D. | Recommended      |                  | Installed Bearing I.D. | Length ± .010"                    | Item Number                                    | Part Number                                    |
|---------------------------|------------------|------------------|------------------------|-----------------------------------|------------------------------------------------|------------------------------------------------|
|                           | Shaft Dia.       | Housing Bore     |                        |                                   |                                                |                                                |
| 1/4                       | .2490<br>.2481   | .3128<br>.3122   | .2518<br>.2492         | 3/8                               | 505009                                         | 04TP06                                         |
| 5/16                      | .3115<br>.3106   | .3753<br>.3747   | .3143<br>.3117         | 1/2                               | 505011                                         | 05TP08                                         |
| 3/8                       | .3740<br>.3731   | .4691<br>.4684   | .3769<br>.3742         | 3/4                               | 505017                                         | 06TP12                                         |
| 1/2                       | .4990<br>.4980   | .5941<br>.5934   | .5019<br>.4992         | 1/2<br>3/4                        | 505022<br>505024                               | 08TP08<br>08TP12                               |
| 9/16                      | .5615<br>.5605   | .6566<br>.6559   | .5644<br>.5617         | 3/4                               | 505029                                         | 09TP12                                         |
| 5/8                       | .6240<br>.6230   | .7192<br>.7184   | .6270<br>.6242         | 1/2<br>3/4                        | 505031<br>505033                               | 10TP08<br>10TP12                               |
| 3/4                       | .7491<br>.7479   | .8755<br>.8747   | .7525<br>.7493         | 1/2<br>3/4<br>1                   | 505039<br>505041<br>505042                     | 12TP08<br>12TP12<br>12TP16                     |
| 7/8                       | .8741<br>.8729   | 1.0005<br>.9997  | .8775<br>.8743         | 1                                 | 505049                                         | 14TP16                                         |
| 1                         | .9991<br>.9979   | 1.1255<br>1.1247 | 1.0025<br>.9993        | 1/2<br>3/4<br>1<br>1 1/4<br>1 1/2 | 505052<br>505053<br>505054<br>505055<br>505056 | 12TP08<br>12TP12<br>16TP16<br>16TP20<br>16TP24 |
| 1 1/4                     | 1.2488<br>1.2472 | 1.4068<br>1.4058 | 1.2528<br>1.2490       | 3/4<br>1                          | 505062<br>505064                               | 20TP12<br>20TP16                               |
| 1 1/2                     | 1.4988<br>1.4972 | 1.6568<br>1.6558 | 1.5028<br>1.4990       | 1<br>1 1/2                        | 505073<br>505076                               | 24TU16<br>24TU24                               |
| 1 3/4                     | 1.7487<br>1.7471 | 1.9381<br>1.9371 | 1.7535<br>1.7489       | 2                                 | 505083                                         | 28TP32                                         |
| 2                         | 1.9987<br>1.9969 | 2.1883<br>2.1871 | 2.0037<br>1.9989       | 1 1/2<br>2                        | 505090<br>505092                               | 32TP24<br>32TP32                               |

**TP™ FLANGE BEARINGS (Inch Sizes)**

| Nominal Bearing Bore I.D. | Recommended      |                  | Installed Bearing I.D. | Nominal Flange O.D. ±.020" | Flange Thick. | Length ±.010" | Item Number      | Part Number        |
|---------------------------|------------------|------------------|------------------------|----------------------------|---------------|---------------|------------------|--------------------|
|                           | Shaft Diameter   | Housing Bore     |                        |                            |               |               |                  |                    |
| 3/8                       | .3740<br>.3731   | .4691<br>.4684   | .3764<br>.3742         | 11/16                      | .052<br>.044  | 3/8<br>1/2    | 506002<br>506003 | 06FTP06<br>06FTP08 |
| 1/2                       | .4990<br>.4980   | .5941<br>.5934   | .5019<br>.4992         | 13/16                      | .052<br>.044  | 3/4           | 506008           | 08FTP12            |
| 5/8                       | .6240<br>.6230   | .7192<br>.7184   | .6270<br>.6242         | 15/16                      | .052<br>.044  | 1/2           | 506010           | 10FTP08            |
| 3/4                       | .7491<br>.7479   | .8755<br>.8747   | .7525<br>.7493         | 1 1/8                      | .068<br>.060  | 1             | 506016           | 12FTP16            |
| 1 1/4                     | 1.2488<br>1.2472 | 1.4068<br>1.4058 | 1.2528<br>1.2490       | 1 3/4                      | .083<br>.075  | 1             | 506025           | 20FTP16            |

**TP™ WASHERS (Inch Sizes)**

| Inside Diameter +.010" | Outside Diameter -.010" | Dowel Hole      |                 | P.C. Diameter -.010" | Housing Recess Depth ±.010" | Item Number | Part Number |
|------------------------|-------------------------|-----------------|-----------------|----------------------|-----------------------------|-------------|-------------|
|                        |                         | Thickness +.002 | Diameter +.010" |                      |                             |             |             |
| 9/16                   | 1                       | .061            | .067            | .786                 | .040                        | 506402      | W07TP       |
| 1 1/2                  | 2 1/2                   | .061            | .192            | 2.005                | .040                        | 506413      | W22TP       |

**TP™ SLEEVE BEARINGS (Metric Sizes)**

| Nominal Bearing Bore I.D. | Recommended      |                  | Installed Bearing I.D. | Length ±.25mm | Item Number | Part Number |
|---------------------------|------------------|------------------|------------------------|---------------|-------------|-------------|
|                           | Shaft Dia.       | Housing Bore     |                        |               |             |             |
| 4                         | 4.000<br>3.992   | 5.508<br>5.500   | 4.048<br>4.000         | 6             | 705009      | M0406TP     |
| 6                         | 5.990<br>5.978   | 8.015<br>8.000   | 6.055<br>5.990         | 10            | 705017      | M0610TP     |
| 8                         | 7.987<br>7.972   | 10.015<br>10.000 | 8.055<br>7.990         | 10            | 705021      | M0810TP     |
| 10                        | 9.987<br>9.972   | 12.018<br>12.000 | 10.058<br>9.990        | 12            | 705025      | M1012TP     |
| 12                        | 11.984<br>11.966 | 14.018<br>14.000 | 12.058<br>11.990       | 15            | 705031      | M1215TP     |
| 14                        | 13.984<br>13.966 | 16.018<br>16.000 | 14.058<br>13.990       | 12            | 705038      | M1412TP     |
| 15                        | 14.984<br>14.966 | 17.018<br>17.000 | 15.058<br>14.990       | 12            | 705043      | M1512TP     |
| 16                        | 15.984<br>15.966 | 18.018<br>18.000 | 16.058<br>15.990       | 25            | 705051      | M1625TP     |
| 20                        | 19.980<br>19.959 | 23.021<br>23.000 | 20.062<br>19.990       | 20            | 705062      | M2820TP     |
| 25                        | 24.980<br>24.959 | 28.021<br>28.000 | 25.071<br>24.990       | 15            | 705079      | M2515TP     |
| 30                        | 29.980<br>29.959 | 34.025<br>34.000 | 30.085<br>29.990       | 40            | 705093      | M3040TP     |
| 50                        | 49.975<br>49.950 | 55.530<br>55.000 | 50.110<br>49.990       | 50            | 705117      | M5050TP     |

**TP™ FLANGE BEARINGS (Metric Sizes)**

| Nominal Bearing Bore I.D. | Recommended      |                  | Installed Bearing I.D. | Nominal Flange O.D. ±.05mm | Flange Thick. ±.25mm | Length ±.25mm | Item Number | Part Number |
|---------------------------|------------------|------------------|------------------------|----------------------------|----------------------|---------------|-------------|-------------|
|                           | Shaft Diameter   | Housing Bore     |                        |                            |                      |               |             |             |
| 6                         | 5.990<br>5.978   | 8.015<br>8.000   | 6.055<br>5.990         | 12                         | 1.00<br>.80          | 8             | 706003      | FM0608TP    |
| 8                         | 7.987<br>7.972   | 10.015<br>10.000 | 8.055<br>7.990         | 15                         | 1.00<br>.80          | 9.5           | 706006      | FM0809.5TP  |
| 12                        | 11.984<br>11.966 | 14.018<br>14.000 | 12.058<br>11.990       | 20                         | 1.00<br>.80          | 12            | 706013      | FM1212TP    |
| 15                        | 14.924<br>14.966 | 17.018<br>17.000 | 15.058<br>14.990       | 23                         | 1.00<br>.80          | 12            | 706018      | FM1512TP    |
| 16                        | 15.984<br>15.966 | 18.018<br>18.000 | 16.058<br>15.990       | 24                         | 1.00<br>.80          | 12            | 706020      | FM1612TP    |

**TP™ WASHERS (Metric Sizes)**

| Inside Diameter +.25mm | Outside Diameter -.25mm | Dowel Hole       |                 | P.C. Diameter +.24mm | Housing Recess Depth ±.25mm | Item Number | Part Number |
|------------------------|-------------------------|------------------|-----------------|----------------------|-----------------------------|-------------|-------------|
|                        |                         | Thickness +.05mm | Diameter +.25mm |                      |                             |             |             |
| 10                     | 20                      | 1.45             | N/A             | N/A                  | N/A                         | 706401      | WM8TP       |
| 28                     | 48                      | 1.45             | 4.120           | 38                   | 1.0                         | 706410      | WM25TP      |
| 52                     | 78                      | 1.95             | 4.120           | 65                   | 1.5                         | 706415      | WM50TP      |

Chamfers: Standard flanged TP Bearings are supplied with 15°/20° chamfers.  
\*Other sizes available on special orders.

Note: The items on this page represent a portion of the TP™ products available at the time of printing. Visit our website ([www.isostatic.com](http://www.isostatic.com)) for a complete list of TP™ products or phone **Customer Service** at **800 621-5500** with any questions.