



SOLVE ™
INDUSTRIAL MOTION GROUP

06

**Standard Mounted
Ball Bearings**



07

**Locking
Mechanisms**



08

**Corrosion-Resistant
Mounted Ball Bearings**



10

Ball Bearings



11

**Roller Bearings, Cam
Followers, Yoke Rollers, &
Roller Thrust Bearings**



12

**Spherical Plain Bearings
& Rod Ends**



13

**Unitized Sphericle
Roller Bearings &**



14

**Split Block Bearings
& Accesories**



16

Precision Roller Chain



17

**Sprockets &
Shaft Collars**



18

Pulleys & Sheaves



19

**Shaft Bushings
& Couplings**



20

**Spur Gears & Racks,
Linear Bearings & Shafting**



21

Solve 360° Service



22

**Distributed
Brands**



Better Together

Combining the complementary strengths of the IPTCI, MasterDrive, PTI, and TRITAN product lines, Solve's brands have become leaders in Metric and American Standard precision bearings and power transmission components. Solve is also the U.S. supplier for a variety of European specialty partners.



Product Brands

IPTCITM

B E A R I N G S

IPTCI's complete line of mounted bearings combines innovation, quality, and affordability. We offer corrosion-resistant bearings for light, standard or medium-duty applications, as well as a full line of standard bearings. Our innovative, reliable and cost-effective solutions are supported with exceptional customer service to give you the performance advantage you need.

Product Categories

- Corrosion-Resistant Mounted Ball Bearings
- Standard Mounted Ball Bearings
- Food-Grade & High Temperature Bearing Inserts

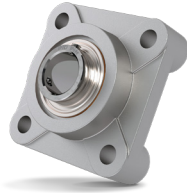

MASTERDRIVE

POWER TRANSMISSION PRODUCTS

MasterDrive is a global leader in power transmission components, providing customers with innovative and quality products designed to meet the highest standards of performance and reliability. MasterDrive is dedicated to providing customers with the best possible service and support, and offers comprehensive solutions for all of their power transmission needs.

Product Categories

- Sheaves & Pulleys
- Bushings & Hubs
- Flex & Jaw Couplings
- Belts & Belt Accessories

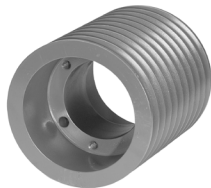

PTITM

P.T. INTERNATIONAL

For more than 30 years, high-performance industries have relied on PTI for high-quality Metric and American Standard bearings and power transmission components. We serve a wide variety of clients with an even wider range of top-quality brands from around the world, and are the U.S. supplier for a variety of select European specialty partners, including Winkel heavy linear products.

Product Categories

- Mounted Roller Bearings
- Mounted Ball Bearings
- Linear Bearings
- Precision Roller Chain
- Metric Power Transmission Components



TRITANTM

BEARINGS & PT COMPONENTS

TRITAN has over 25 years of experience producing world-class precision bearings and power transmission components. Manufactured using heat-treated select alloy steel and backed by advanced quality control and testing systems, TRITAN uses the latest technologies to increase the life expectancy and performance of our bearings with careful adherence to lubrication requirements.

Product Categories

- Ball & Roller Bearings
- Mounted Ball Bearings
- Spherical Plain Bearings & Rod Ends
- Cam Followers & Yoke Rollers
- Precision Roller Chain & Sprockets



Combining the complementary strengths of the IPTCI, MasterDrive, PTI, and TRITAN product lines, Solve Industrial Motion Group has grown to become a leading provider of high-quality bearings and power transmission components.

Superior Product Availability

Solve provides complete coverage of Metric and American Standard sizes, with a comprehensive product catalog of 100,000+ bearings and power transmission components. With the Solve Express™ program, you'll have the parts you need ASAP, with same-day delivery available on many critical products.

Quality + Performance + Price

Our highly honed supply chain has been forged and tempered with demanding quality assurance programs to ensure that our products perform under the most demanding conditions. Better yet, that performance always comes at a fair price — the Solve Sweet Spot™ provides the perfect blend of performance and value.

The Solve Difference

Expertise You Can Rely On

With Solve, you can count on responsive, knowledgeable technical support and extensive engineering capabilities earned from more than 50 years of experience solving bearing and power transmission challenges. For really tough problems, we can custom engineer and manufacture bearings and components to fit virtually any need.

Attentive Service From People You Trust

The strength of our product catalog is complemented by our unparalleled commitment to customer service. Solve 360 Service™ gives you 24/7 access to our team of highly trained technical support professionals — with an average 20+ years of experience — who will always go the extra mile to get you what you need, when you need it.

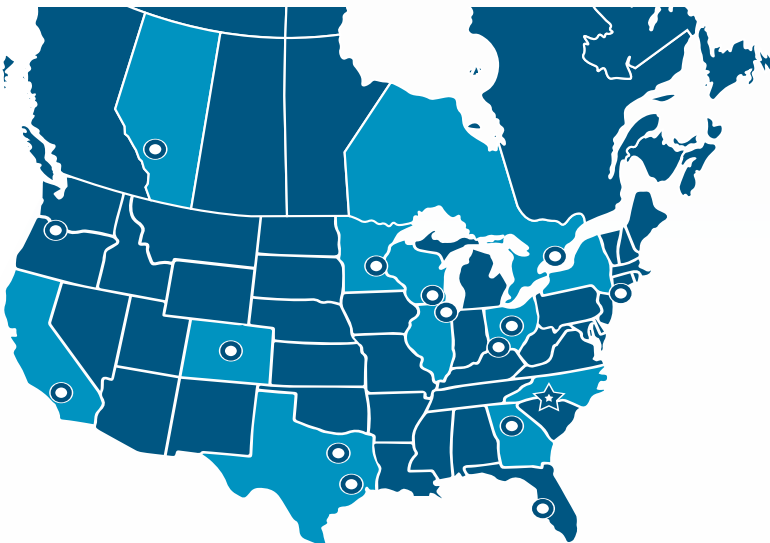

Charlotte, NC | Columbus, OH |
Hauppauge, NY | Cincinnati, OH |
Atlanta, GA | Minneapolis, MN |
Houston, TX | Tampa, FL | Dallas, TX |
Denver, CO | Los Angeles, CA |
Portland, OR | Toronto, ON | Calgary, BC |
Fort Atkinson, WI | Chicago, IL

Standard Mounted Ball Bearings

Solve proudly offers the widest assortment of housings and ball bearing inserts in the industry. We stock over 700 housing types including popular European Metric, Asian Metric and American Standard configurations. Stock product is available through 140mm (Metric) and 4" (American Standard).

Housing Styles

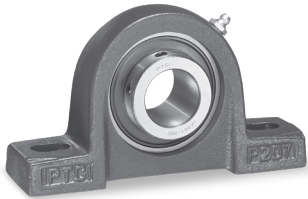

Pillow Block



4-Bolt Flange



2-Bolt Flange



3-Bolt Flange

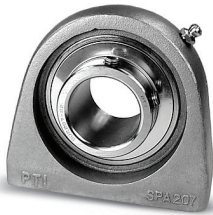

Tapped Base



Hanger Bearing



Piloted 4-Bolt Flange



Swivel Flange

Medium Duty Housing Styles

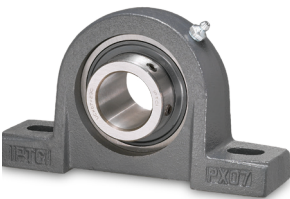

Medium Duty Pillow Block



Medium Duty Flange



Medium Duty Piloted Flange

Heavy Duty Housing Styles



Heavy Duty Pillow Block



Heavy Duty Flange

Specialty Blocks



Fan & Blower Blocks

These heavy-duty bearings are ideal for Fans, Blowers, Bench Grinders, Buffers, and Jack Shafts. All housings are equipped with two bearings, each with individual grease wells, and feature Ductile Iron housings to provide superior strength over the more common Cast Iron housing material.

Take-Up Units



Take-Up Unit

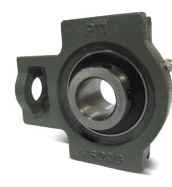

Wide Slot Take-Up Unit



Wide Slot Take-Up Frames

Locking Mechanisms

As one of the only bearing manufacturers to offer all four styles of locking mechanisms, Solve can help customers with even the most demanding shaft attachment applications.

Setscrew

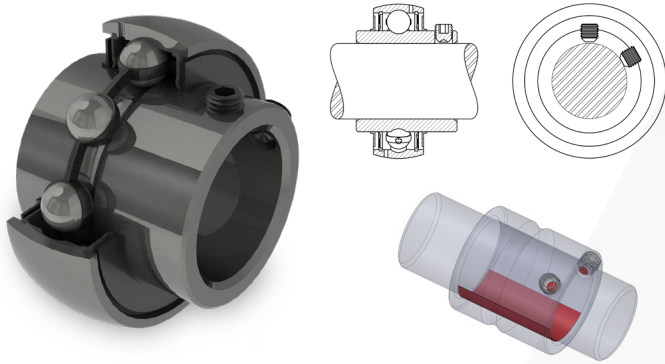

Economical, simple, general purpose.

Eccentric Collar

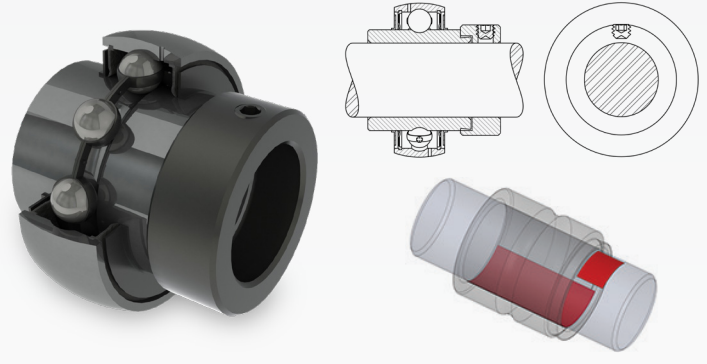

Economical, simple, general purpose; suitable for uni-directional use.

Concentric Collar

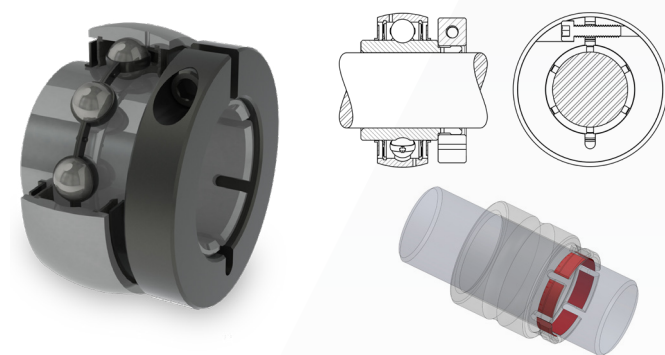

Improved balance for higher speeds and increased wear resistance.

Adapter Mount

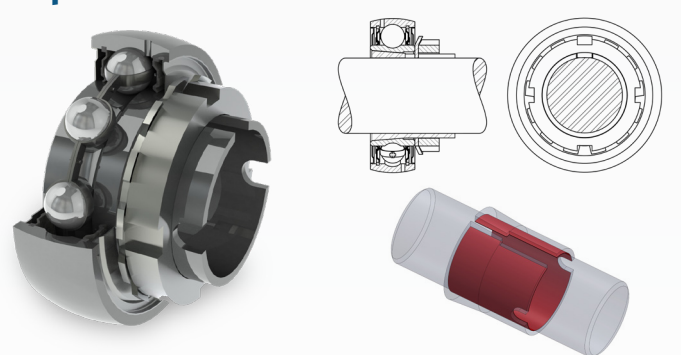

Offers least amount of vibration and most concentric grip to shaft; best for high speeds.



Custom Solutions

Triple Lip Seal option available for additional protection from contaminants and moisture on select setscrew and eccentric inserts. See page 9 for more.

High Temperature (HT) & Solid Lube Bearing Inserts



High Temperature Ball Bearings Inserts will operate at higher temperatures than standard bearing units and can be installed in any of our European or American Standard housing types.

Features

- Protection from elevated temperatures and corrosive environments up to 260°C (500°F).
- Will not become brittle like polyamide or glass fiber cages.
- High-temp lubricant rated for 260°C (500°F)



Solid Lubrication provides constant and consistent lubrication for maintenance-free performance, while also serving to block debris and raceway contamination that will significantly extend the bearings life. Solid Lubrication is available in all inch and metric inserts, units, as well as deep groove radial ball bearings.

Corrosion-Resistant Mounted Ball Bearings

Solve offers a wide assortment of corrosion-resistant units — including IP69K-certified bearings — to stand up to the high-temperature, high-pressure caustic washdowns found in the food, beverage, pharmaceutical and other industries. Bearings are lubricated with high performance NSF H1 Food Grade grease and stainless steel inserts are available with setscrew or eccentric locking collars.

Housing Styles



2-Bolt Flange*

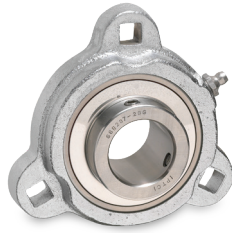

3-Bolt Flange

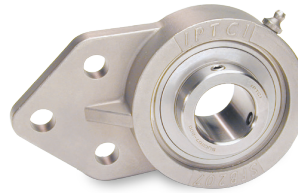

3-Bolt Flange Bracket*

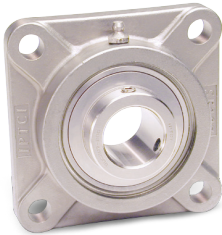

4-Bolt Flange*



Piloted 4-Bolt Flange*

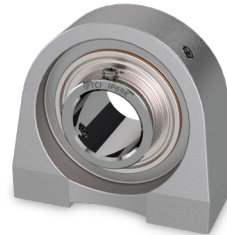

Tapped Base

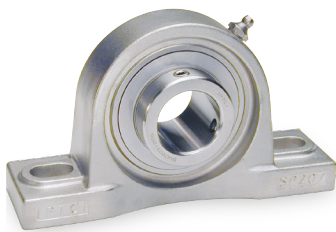

Pillow Block*



Hanger Unit



Take-Up Unit*

*Available in Medium Duty

Housing Materials



Stainless Steel



Nickel Plated



Thermoplastic

Corrosion-Resistant Stand-Off Series Housing Styles

Stand-Off Series mounted bearing units significantly reduce areas for bacterial growth, helping to minimize the potential for product contamination and the needless costs associated with it.



2-Bolt Flange



4-Bolt Flange



3-Bolt Flange Bracket



Tapped Base

Corrosion-Resistant Insert Types

All of Solve's corrosion-resistant bearing inserts use high quality H1 Food Grade grease that is water resistant to reduce washout while also avoiding product contamination for food and beverage applications.



Stainless Steel — Setscrew (SUC, SSB)



Stainless Steel — Eccentric Collar (SHC, SNA)



Stainless Steel — Cylindrical OD (SSER)



Hard Chrome Coated (CUC)



Black Oxide (BUC)

End Covers

End Covers provide another layer of protection for the inside of the bearing during wash downs to extend bearing life.



Thermoplastic End Cover

Insert Seal Options



Single Lip Seals

Single Lip seals are an economical choice to provide basic protection for a bearing. A nitrile rubber seal and slinger help keep lubricant inside the bearing and contaminants out. Also available with a silicone seal and stainless steel slinger for improved protection.



Triple Lip (L3) Seals

Triple Lip (or L3) sealed bearings provide more protection in harsh environments. They are often an ideal choice for dirty, high-moisture applications such as those found in agriculture, turf, and car washes. From 3/4" to 3" bore, and metric sizes 20mm to 60mm, Solve's L3 inserts are available in a wide range of styles and in setscrew locking or eccentric locking collar.



IP69K Series Sealed Bearings

IP69K Series bearings are ideal for food manufacturers, poultry and meat processors, pharmaceutical manufacturers, bottling companies, canning operations, and car washes. They provide increased bearing life and reduced downtime in any environment where bearings are subject to close-range, high-temperature, high-pressure caustic washdowns and frequent temporary submersions.

A unique triple-lip molded rubber composition provides superior protection against dust and liquid intrusion without the need for external seals or covers.

IP69K series bearings are "lubed for life" with H1 Food Grade grease to eliminate lube holes, grease zerks, and other potential areas of intrusion.

Ball Bearings

Ball Bearings



Radial & Deep Groove Ball Bearings



Double Row Angular Contact Ball Bearings



Farm Implement & Disc Harrow Bearings



Stainless Steel Food Grade Ball bearings



Self-Aligning Ball Bearings



Thrust Ball Bearings



Angular Contact Ball Bearings

Miniature & Instrument Precision Ball Bearings

Solve offers a comprehensive assortment of miniature and instrument precision ball bearings in metric and inch sizes with bores starting under 1mm (.04"). They are available Abec 1 to Abec 5 in both chrome and stainless steel in a wide variety of configurations that include open, sealed or shielded, extended inner rings, flanged outer rings, various radial play and retainer options, and importantly either standard or custom lubrications (including food grade and solid lube) designed to meet specific applications needs.



Miniature Radial Ball Bearings



Stainless Steel Flanged Miniature Ball Bearings



Stainless Steel Shielded Miniature Ball Bearings



Miniature Thrust Bearings



Flanged Open Miniature Ball Bearings



Flanged Sealed Miniature Ball Bearings



Flanged Shielded Miniature Ball Bearings

Roller Bearings

Roller Bearings



Sealed Spherical Roller Bearing



Cylindrical Roller Bearings



Needle Roller Bearings



Spherical Roller Bearings



Tapered Roller Bearings (Sets, Cups & Cones)

Cam Followers & Yoke Rollers



Cam Followers



Yoke Rollers

Roller Thrust Bearings



Tapered Roller Thrust Bearings



Cylindrical Roller Thrust Bearing



Needle Roller Thrust Bearings



Spherical Roller Thrust Bearings

Spherical Plain Bearings & Rod Ends

Spherical Plain Bearings

TRITAN spherical plain bearings utilize carbon chromium steel-on-steel which is hardened, phosphated and treated with Molybdenum Disulfide (MoS₂) to reduce friction. Bearings are also available in self-lubricating designs utilizing PTFE-lined races offering a maintenance-free solution with lower friction.

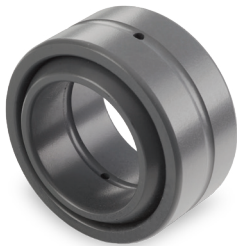

Radial Inch & Metric



Maintenance Free



Angular Contact



Thrust

Rod Ends

Solve offers a complete line of American Standard and Metric rod ends capable of high dynamic and static axial loads as well as high speeds. Rod ends are available as right or left hand and male or female threaded units.



Precision Rod Ends

- Steel-on-bronze for lubricity, smoother operation, and longer dynamic life
- Available in Inch and Metric sizes



Maintenance Free Rod Ends

- No lubrication required
- Metal-on-PTFE construction to minimize wear and extend life
- Stainless Steel options available for corrosive environments
- Available in Inch and Metric sizes



Standard Duty Rod Ends

- Most economical design for a wide range of light to heavy duty motion transfer applications
- Available in Inch and Metric sizes



Heavy Duty Rod Ends

- Heavy duty, zinc-plated construction is suited for high speed applications
- Available in Metric sizes



Heavy Duty Maintenance Free Rod Ends

- Steel-on-bronze for lubricity, smoother operation, and longer dynamic life
- Available in Inch and Metric sizes



Hydraulic Rod Ends

Unitized Spherical Roller Bearings

Roller bearings generally offer higher radial load capacities but lower axial load capacities than equivalent-sized ball bearings.

Features

- Interchangeable with competitive brands
 - » SR2200 Series compares to “2000” Series Products
 - » SRE compares to “E” Dimensioned Products
- Elongated bolt holes ensure interchangeability with all major competitive brands
- Premium lithium grease with a temperature range of -22°F to 284°F comes standard
- 21 Shaft Sizes from 1-7/16" to 5"
- Setscrew Lock Collars for easy installation
 - » Dual Collars standard above 4" and optional on 2-7/16", 2-15/16", 3-7/16", and 3-15/16"

Expansion & Non-Expansion Units

All sizes and styles are available in both Expansion and Non-Expansion versions. Expansion capability of up to 7mm (>1/4").

SRE & SR2200 Series Unitized Spherical Ball Bearings

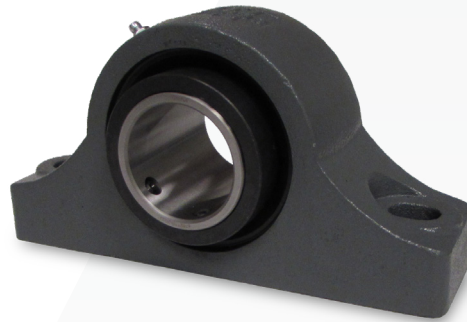

SRE 2-Bolt Pillow Block

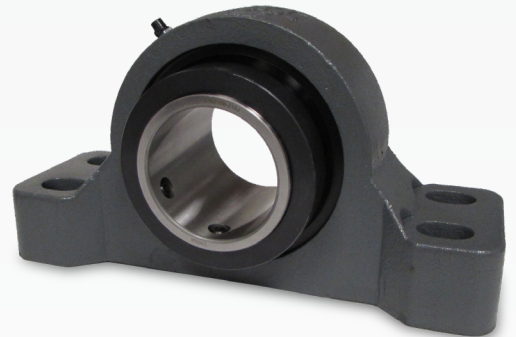

SRE 4-Bolt Pillow Block



SR2200 2-Bolt Pillow Block



SR2200 4-Bolt Pillow Block

Flanges



SRE & SR2200
4-Bolt Flange



SRE & SR2200
4-Bolt Piloted Flange

Take-Up Units

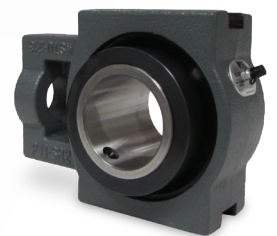

SR2-WSTU Wide
Slot Take-Up



Solve offers customization capabilities for all units, such as modifications to allow for thermal or vibration sensors.

Split Block Bearings

Split blocks are ideal in a variety of applications including those with heavy loads, high and low speeds, grease or oil lube, as well as the most challenging conditions. The new solid base housing is among the most robust blocks available. Housing caps and bases are paired to ensure a controlled bearing fit. Large pry slots help make access to the bearing easy.

Features

- Rugged base provides superior housing strength and allows for oil equalization under bearing seat ensuring a balanced oil level on each side of the bearing.
- Housing caps and bases paired to ensure controlled bearing fit.
- Pry slots make housing disassembly simple (match marks also possible).

Housing Materials

- Cast Iron
- Ductile Iron
- Cast Steel

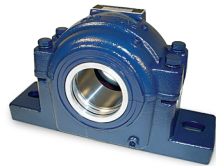

SAF & SDAF Series

Solve stocks the widest range of split cap pillow blocks in the industry. Our SAF and SDAF blocks are available in stock from 3/4" up to 24" or 20mm up to 400mm with larger sizes available on request. Multiple seal options are available to suit almost every application, and they're available in both 2-bolt and 4-bolt housing styles.

SDAF Asymmetric

SDAF Asymmetric Pillow Blocks allow the bearing to be positioned closer to the load to reduce shaft bending thereby increasing life. These units are typically used on shaft sizes exceeding 18," but smaller units are available.

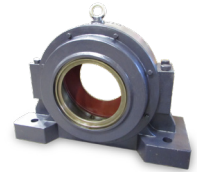

SN & SNG Series Plummer Blocks

SNG Metric Plummer Blocks are interchangeable with other SN designs. They are available in 200, 300, 500, and 600 series. SNG units can be used with spherical roller bearings or self-aligning double row ball bearings.

Large Bore Plummer Blocks

S3000 and SD3100 Series are adapter mounted Metric Plummer Blocks designed to industry standard European Metric specifications. The SD3100 units are available up to 380mm shaft diameter and S3000 units up to 260mm shaft diameter.



HSPA Take-Up Units

HSPA Take-Up Units are generally made-to-order and can be provided in shaft sizes through 360mm. Standard units accommodate 222, 230, 231, or 232 series roller bearings.

SAF & SDAF Seal Options

Aluminum Labyrinth



LER



PER, PER-PTV



LER-DC
Dust Cover
Wiper Seal

Drop-In Taconite Labyrinth



TER, TER-OS

Metric Plummer Block Seal Options



Rubber



Aluminum



Taconite



Steel

**More seal options available to suit every application.*

Available Options

End Covers available for both Split Blocks and Metric Plummer Blocks for added bearing protection.



EPR End Cover to seal one end of the housing.

Adapters, Nuts, Withdrawal Sleeves

Solve offers Metric and Imperial adapter sleeves and nuts as well as Metric withdrawal sleeves and nuts, hydraulic nuts and removal sleeves to assist with mounting and removal.

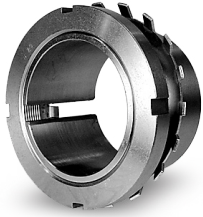

SNW & SNP Series
(Inch-Based Threads)



H Series
(Metric-Based Threads)



Standard
Withdrawal Sleeves

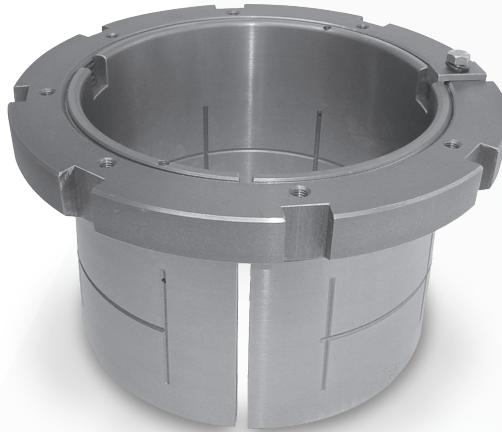

Hydraulic Adapter

- Used for bearing removal by breaking the hold between the bearing and adapter without damaging either component.
- Life saver for installation mistakes on large units.
- Series: OH 2300, OH 3000, OH 3100, OH 3200.

Hydraulic Nut

- Used for bearing installation.
- Torque wrench is utilized to tighten setscrews pushing the bearing up the adapter. This causes the bearing inner bore to slightly expand, which removes the internal clearance from the bearing, creating a press fit of the inner ring to the shaft.
- Much easier to install on large units compared to spanner wrench and giant breaker bar (reduces installation costs).
- Series: OH 2300, OH 3000, OH 3100, OH 3200.



Bearing Insert Options



Spherical Roller Bearings

- 222, 223, 230, 231 and 232 series
- Heavier loads, lower speeds



Self-Aligning Double Row Ball Bearings

- 1200, 1300, 2200 and 2300 series
- Lighter loads, higher speeds



Custom Solutions

Do you need to replace a split block unit that is no longer manufactured? Do you need the ability to integrate an RTD or vibration sensor?

Solve's team of experienced engineers can help. From special mounting or application requirements to customized cast housings, Solve can develop solutions for even the most challenging applications. See page 21 for more.

Precision Roller & Engineered Chain

With advanced manufacturing techniques as well as specialized heat treatment and testing, Solve delivers quality chain products with features that improve wear resistance and provide greater fatigue strength.

Precision Roller Chain



ANSI & Metric (British Standard) Roller Chain
Available in Standard and Heavy Duty



Conveyor Chain



Cottered Chain



ANSI & Metric (British Standard) Attachment Chain

Specialty Chain

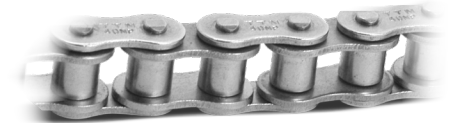

Hollow Pin Chain



Rubber Top Chain

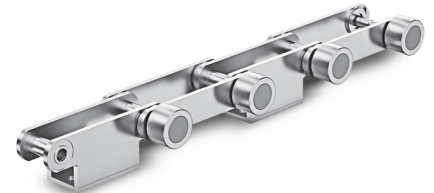

Engineered Chain



Lumber & Agricultural Chain

Stainless Steel & Corrosion-Resistant Roller Chain

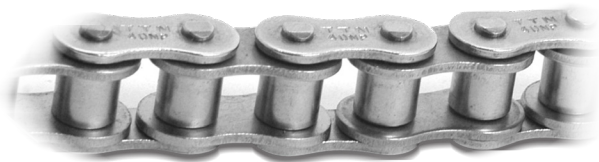

Corrosion-Resistant Roller Chain
Stainless Steel, Nickel Plated & Dacromet Coated Options



Marathon Lube-Free Chain

Precision Roller Chain Sprockets

Forged (never sintered) hardened teeth, black oxide standard for corrosion resistance, available in both stock bore, a wide assortment of finished bore sizes with keyway and set screws, and bushed.



Plate Type Sprockets
(Standard & Stainless Steel [AISI 304L])



Hub Type Sprockets
Available Stock/Plain Bore or Finished Bore



QD Bushing Style Sprockets



Tapered Bushing Style Sprockets

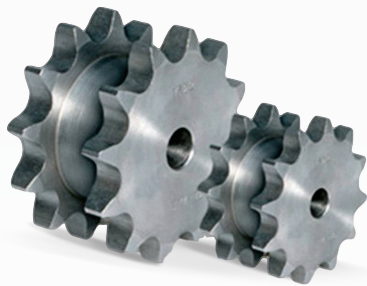

Double & Double-Single Sprockets



Idler Sprockets

Shaft Collars



Setscrew



One-Piece Clamp Style



Two-Piece Clamp Style

Power Transmission Components

Solve Power Transmission Components are manufactured with the most technologically advanced machinery, producing world-class power transmission products. All our power transmission products use high-quality materials and our advanced quality control and testing systems ensure the highest quality.

Pulleys & Sheaves

Solve Power Transmission Components are manufactured with the most technologically advanced machinery, producing world-class power transmission products. All our power transmission products use high-quality materials and our advanced quality control and testing systems ensure the highest quality.



V-Belt Pulleys & Sheaves
Available in Bored to Size or Bushed



Variable Pitch Adjustable Pulleys



Synchronous Timing Pulleys



Tapered Bushing Timing Pulleys



Metric V-Belt Sheaves & Variable Pitch Pulleys

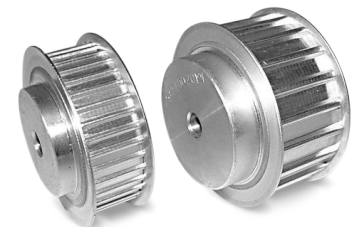

Metric Timing Pulleys



Super Torque Timing Pulleys



Poly-Chain GT Pulleys



Drive Solutions

SOLVE can put it all together for you, sheaves, bushings and belting for a coordinated system from one source.

There are many ways to transfer power from one point to another and change speeds. Given a few inputs our MasterSelect program will provide you with multiple options on sheave sizes and variations on the number of grooves to accomplish the job. The program will then show you the relative cost of different approaches, so that you can optimize the components or utilize on hand parts.

By simply entering the Horsepower and Driving and Driven speeds, a Service Factor, Shaft Diameters and the acceptable Center Distance range as many as 25 solutions can be derived.

Advanced Inputs allow the user to enter allowable Belt Types and choices of Sheave Mounts from Bored to Size, QD Bushed, DST-Double Split Taper or TB Bushed designs.

Further input of Pitch Diameters and Allowable Speed Variation, Sheave Face Width maximums, or number of grooves are just some of the ways that a very custom solution can be generated.

Please email all questions to engineering@solveindustrial.com

Shaft Bushings



Quick Disconnect Style Bushings



Tapered Style Bushings



Double Split Tapered (DST) Bushings



Keyless Bushings



Weld-On Hubs

Elastomeric Flexible Couplings

Jaw Couplings provide standard shaft-to-shaft connection for general duty applications.

These compact no-lube couplings consist of two hubs paired with an elastomer element (spider).

The element eliminates metal-to-metal contact and acts as a shock absorber.

The design maintains performance even if the elastomer element fails.



Flexible Shaft Jaw Coupling Hubs & Spiders

- Available in Cast Iron
- Rubber Spider

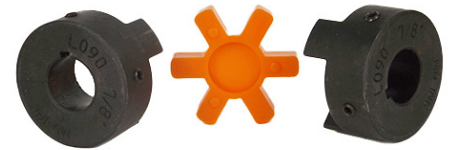

Straight Jaw Coupling Hubs & Spiders

- Available in Sintered Metal or Cast Iron
- NBR Rubber Spider

MD Flex (Sleeve) Couplings

MD Flex (Sleeve) Couplings use a gear-shaped sleeve between 2 flanges for use in high-speed and high-torque applications.

The rubber sleeve can accommodate multiple types of misalignment, dampening, and end float. MD Flex Couplings are also maintenance-free and do not require lubrication.

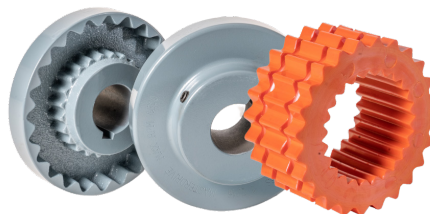

MD Flex Couplings

- Allows for 4 way flexing (Parallel, Angular, Torsional & Axial)
- Smooth and quiet performance
- Neoprene, Hytrel, and EPDM Inserts

Spur Gears & Racks

Spur gears offer an economical means for efficiently and effectively controlling rotational motion, or converting rotational to linear motion, or even clockwise to counterclockwise movement.

Key Features

- 20° pressure angle metric spur gears modules 1-8
- Bored to size, for weld on hubs or keyless bushing

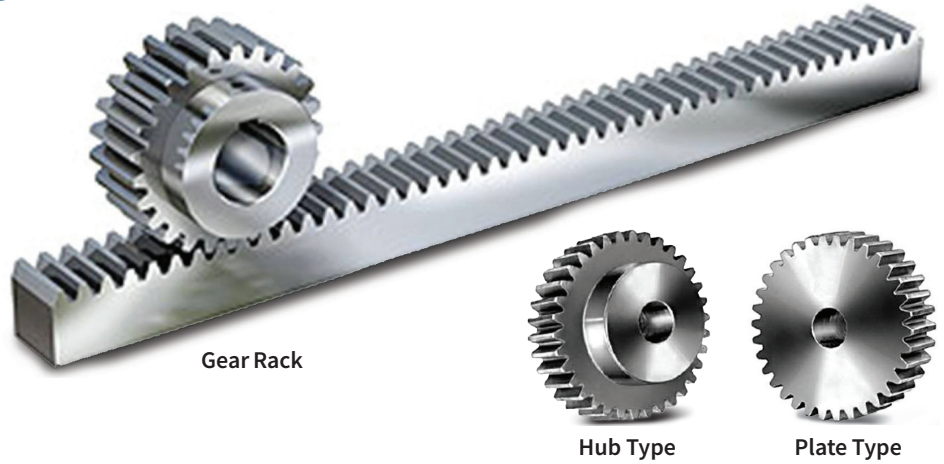

Linear Bearings & Shafting

High performance linear ball bearings, shafting and shaft supports available in both Inch and Metric sizes with open and closed configurations that are fully industry standard and interchangeable. Our round rail linear bearing products are high speed, cost effective, accurate, and easy to install.

- Floating bearing plate/polymer cage design offers three times the load capacity or over 27 times more travel life compared to conventional linear ball bearings.
- Precision ground bearing tracks are made from heat treated steel alloy, providing smooth linear motion and high performance.
- Integral floating seals keep lubrication in and dirt out, and our industry standard anodized aluminum pillow blocks include lubrication ports.



**Linear Ball Bearing Bushings
(Open & Closed)**



**Pillow Blocks
(Open & Closed)**



**Support Rails
& Assemblies**



Shaft Support Blocks



Standard & Pre-Drilled Shafting

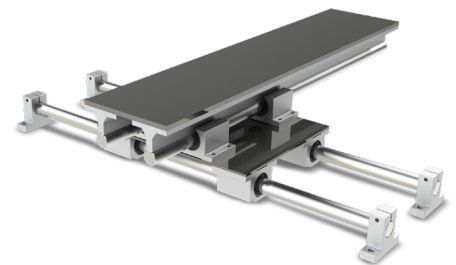

Application Support

Solve 360° Service

Customer & End-User Support



Our team is dedicated to meeting your bearing and power transmission needs with one call. When you need help keeping your operation running smoothly, we have experts standing by.



24/7 Call-in
Customer Support
800-763-4434



20+ years average
experience from industry
professionals
who have actively
worked in the industry



All Solve-manufactured
products must meet the
stringent measures of
Solve's ISO 9001 QMS
certified quality control
program.



Rapid shipping of
replacement parts or
other components upon
request — including
Solve Express™ same-day
shipping.

Solutions by SOLVE

Solutions by SOLVE includes distribution of specialized and niche brands of bearings and transmission components. These products meet the needs of specific applications and or industries or are supplied because they cover a range of items not produced by SOLVE. As with the SOLVE brands these items are stocked in our distribution centers and ready for immediate shipment.

Winkel Linear Bearings



WINKEL heavy duty linear components feature Combination Bearings and Profiles that provide precision linear motion in demanding environments. Combination Bearings fit precisely into channels providing linear guidance with high radial and thrust load capacities. Anti-corrosion protection options are also available as required based on application needs.



Combined Bearings

WINKEL Combined Bearings have suitable profiles and flange plates. The bearings are a cost-efficient solution for verticle and horizontal movement. They are offered with detailed and particularized technical information, drawings and 3D models.

Eich Roller Bearings



Eich is the industry leader for high temperature, heavy load bearings. Eich Bearings are frequently used in Steel Mills or applications of extreme temperature such as furnaces or continuous casters.



ABC Roller Bearing

The ABC roller bearing stands for the so-called Anti Blocking Cage, which represents a special form of Spring bushing bearings compared to the usual solid roller cages. The ABC stock has a snap cage instead.

Roll-Ring Application Product



Keeps chain aligned. No adjustments – ever! Installs in just seconds and stays put. Reduces downtime. No alignment, no brackets to mount. Dampens chain whip, reducing wear and noise of the drive.

Great for reversing drives. Operating temperature range from -4°F to 158°F. Duplex or triple strand chain? Use two or three side-by-side.



IBC Wälzlager GmbH Industrial Bearings & Components

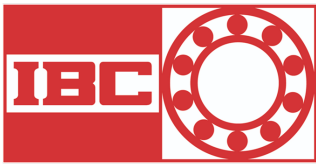

IBC is a manufacturer of high precision ball and roller bearings, based in Germany. They specialize in angular contact spindle bearings produced in P2 (ABEC 7/9), equipped with high-speed fabric reinforced phenolic resin cages. The bearings are available in a wide variety of contact angles with 15° and 25° being the most common, as well as light, medium or heavy pre-loads.

As well, most sizes are available in sealed configuration (2RS) for increased protection from contaminants. Ball Screw Support Bearings with contact angles up to 60° are also produced and stocked for immediate shipment.

SilverThin Bearing Group



SilverThin is a leading US manufacturer of Thin Section Bearings. These bearings help reduce total cost in a system by allowing design efficiency over standard bearings sizes. Typically used in applications in which the space and weight requirements of a system are major factors in the overall design and manufacturing cost. Common applications include: Robotics, Medical Equipment / Xray / MRI, Turntables, Semi-Conductor Manufacturing, Food, Beverage and Canning Equipment.

Bearings are produced with either radial contact, angular contact or 4-point contact, with cross sections ranging from 3/16" to 1", and bore sizes up to 12".

SilverThin also produces Slewing Ring Turntable Bearings. These specialized bearings are made with internal or external gears, or without gears, and are commonly used in applications such as cranes, rotary tables, rotating displays, conveyors, wind turbines, satellite antennas, and robots.

MTK Bearings



MTK is a manufacturer of high-quality ball and roller bearings. Headquartered in Europe, they produce bearings in accordance with German engineering standards that are supplied to customers in 83 countries worldwide. Their core (stocked) product range includes Cylindrical and Spherical Roller bearings common in heavy duty applications such as Construction Machinery, Cranes, Wind Generation, Oil & Gas, & Steel.

Other Brands

Name	Location	Products
A&S Fersa	Spain	Tapered Roller Bearings
KSM	Japan	Radial & Self Aligning Ball Bearings
Koyo/JTEK	Japan	Radial Ball/Needle Roller Bearings
NB	Japan	Linear Motion Bearings



SOLVE

INDUSTRIAL MOTION GROUP



Solve Industrial Motion Group Corporate Headquarters Charlotte, NC - USA
24/7 SALES: 704-588-1091 TOLL-FREE: 800-763-4434
sales@solveindustrial.com