



Martin

The ONE you rely on



Martin

About *Martin*

Martin is a leading supplier of power transmission components, material handling systems and industrial hand tools. A trusted authority in the marketplace, *Martin* leverages a deep knowledge of power transmission and material handling applications to provide reliable cost-saving solutions to its industrial customers.

Operating from more than 34 locations worldwide, *Martin* carries the vast inventories of a global company while consistently delivering exceptional local service and support.

Known for meeting tight deadlines and solving unique manufacturing challenges, *Martin* keeps the industrial world moving efficiently.





Martin

From Humble Beginnings...

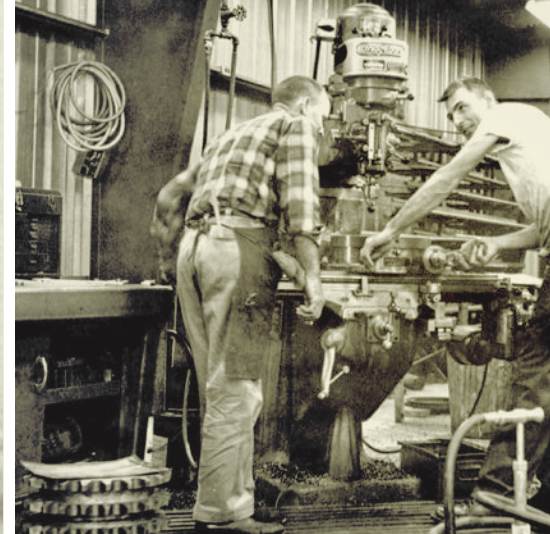



Martin was founded in 1951 based on the vision of Joe Martin Sr. with a simple philosophy, “Make quality products, have plenty of them available, and make it easy for customers to do business.”

Today each *Martin* facility stocks an extensive inventory of its product lines and has the ability to manufacture or custom alter parts for emergency situations. Local service and on-site field service ensure that customers maximize uptime and efficiency.

After more than 65 years of adapting with growing industries, *Martin's* continued focus on quality, inventory, and service makes *Martin* the one you rely on.

***To Unmatched Quality
Inventory & Service***

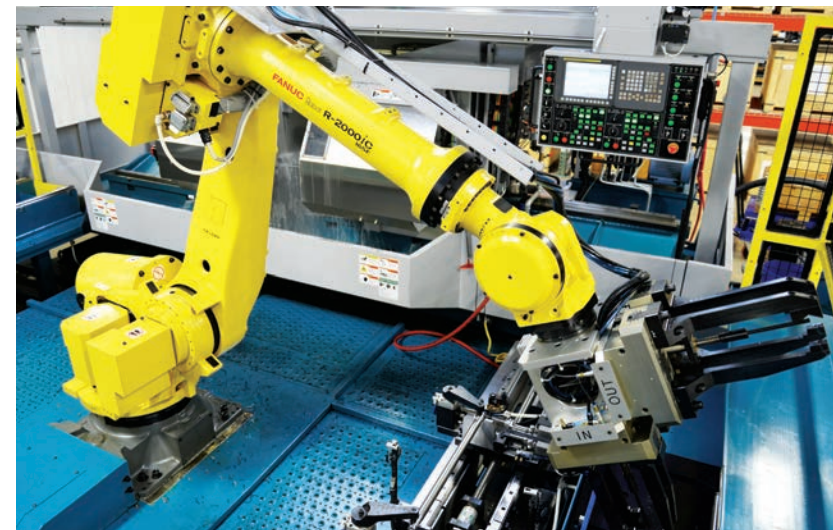

Martin





Power Transmission

Power Transmission Products When and Where You Need Them



Martin carries the largest inventory of stock power transmission components in North America and offers lightning fast delivery times for altered and made to order parts to keep your equipment in motion.

SPROCKETS 

GEARS 

SHEAVES 

SYNCHRONOUS SPROCKETS 

COUPLINGS 

BUSHINGS 



Power Transmission

Power Transmission Products When and Where You Need Them



Sprockets

Martin sets the standard for sprocket manufacturing with the most extensive offering of stock and made to order sprockets.

Gears

From spur gears to worm gears, *Martin* provides a massive inventory of gears and offers quick delivery on a wide range of specialty gears.

Sheaves

Martin keeps the industry's v-belt drives running with stock and made to order sheaves made in North America.



Synchronous

Martin supplies reliable synchronous sprockets and timing belt pulleys for all major brands of high-performance belts.



Couplings

Martin carries a complete line of shaft couplings in a wide range of materials to ensure shaft alignment and increase uptime.



Bushings

Martin stocks all popular types and sizes of interchangeable bushings and weld-on hubs to fit any industrial application.

Martin



 **Bucket Elevators**

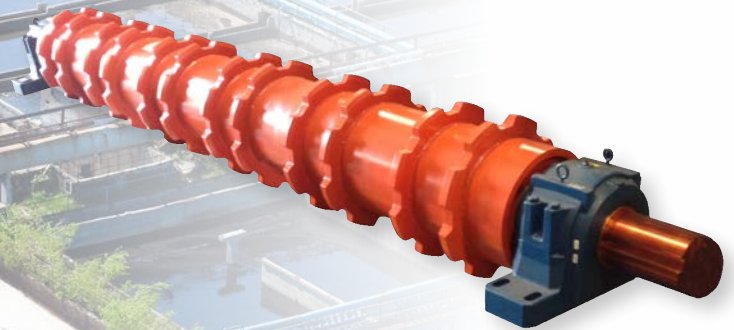

 **Sprocket Rollers**



Material Handling

*Efficient Material Handling Systems
& Reliable Components*



 **Screw Conveyors**



 **Belt Conveyors**

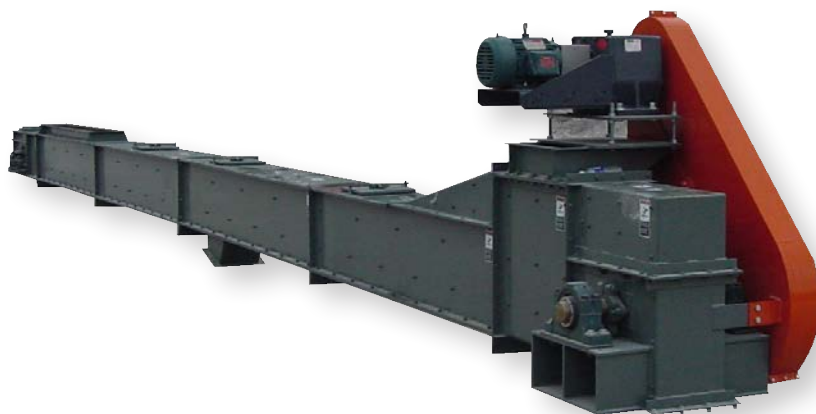

 **Drag Conveyors**



 **Food-Grade &
Metal Detectable
Specialty Conveyors**

Martin manufactures efficient, reliable conveyors and components in strategic locations throughout North America. When it comes to material handling challenges, an experienced *Martin* field support technician is always just a phone call away.



 **Components**



Heavy-Duty Conveyor Pulleys

High-Performance Conveyor Pulleys for Any Application

Martin's heavy-duty conveyor pulleys are manufactured to offer maximum protection against premature failure in harsh applications. *Martin* delivers stock and made to order conveyor pulleys within hours and days, not weeks.

Martin ELITE SERIES DRUM PULLEYS ●

HEAVY-DUTY WING PULLEYS ●

ENGINEERED CLASS PULLEYS ●

SPECIAL CONSTRUCTION PULLEYS ●

● *Martin* Elite Series Drum Pulleys

Are engineered to offer an efficient and improved alternative to standard stock drum pulleys.





Martin



Engineered Class Pulleys

The *Martin* engineered class pulley (ECP) line can be used effectively in every industry to ensure optimum performance and pulley longevity.



Clean Flight® Wing

The innovative design of *Martin's* Clean Flight® wing pulley combines the material rejection technology of a screw conveyor with the durability of a heavy-duty wing pulley. Constructed with distinctly aggressive materials & thick flights, Clean Flight® wing pulleys are built to withstand abrasive applications.



Wing Pulleys

Available in standard, quarry, and mine duty configurations, *Martin's* heavy-duty wing pulleys meet the demanding requirements of harsh applications.

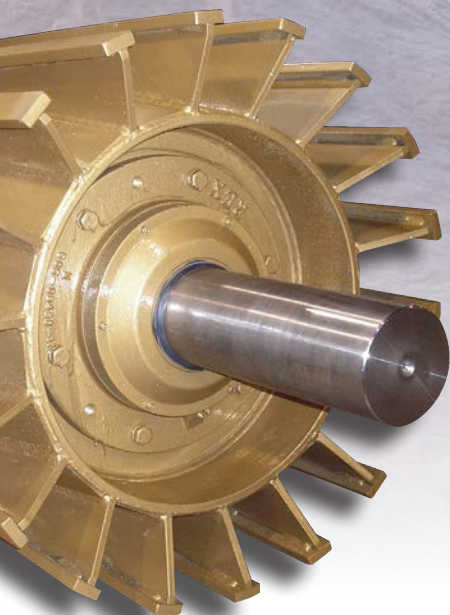

Martin

Martin's heavy-duty conveyor pulleys components follow the same quality manufacturing standards to support the best performance for your conveyor belt.

LAGGING 

BUSHINGS & HUBS 

TAKE-UP FRAMES 

SHAFTING 

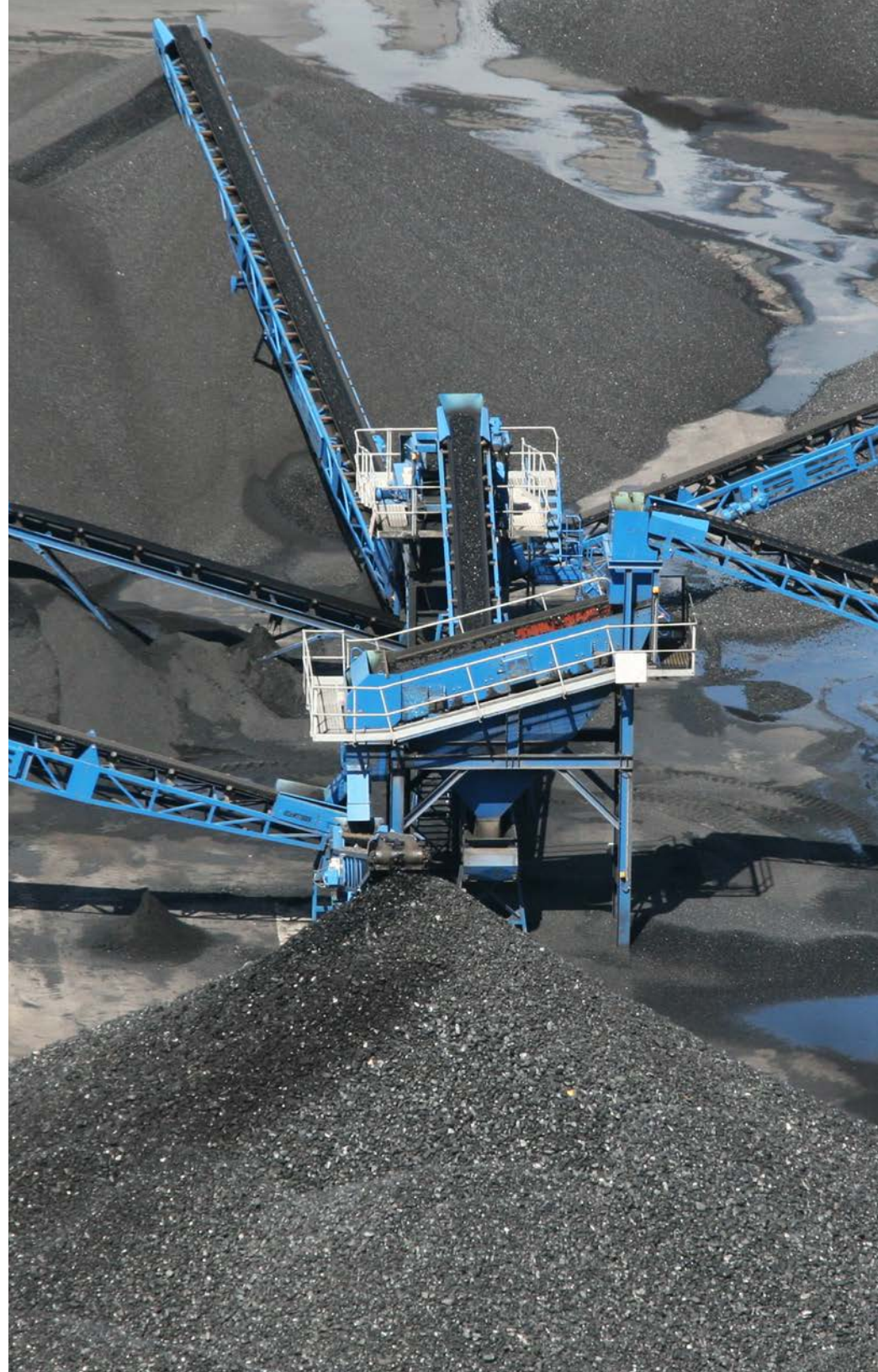



Conveyor Pulleys Components

Quality Components for all Conveyor Needs



Lagging

The right lagging on a pulley is one of the most cost efficient ways to reduce the risk of slippage. *Martin's* experienced team will advise which lagging is the best problem solver for your needs.



Shafting

Martin offers a wide variety of solutions for your shafting needs, from cold finish 1/2" diameter to hot roll material in excess of 15" diameter.

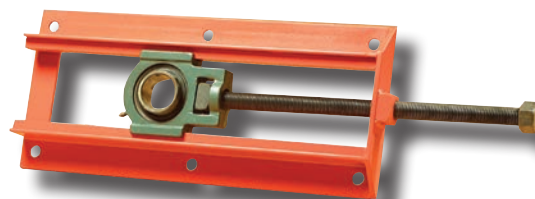

Take-Up Frames

A properly designed belt conveyor will require the use of a take-up device, *Martin* take-up frames are fabricated from steel, offering superior strength and durability in the most rugged conditions.



Bushings & Hubs

Martin's bushings and weld-on hubs are specifically designed for use on conveyor pulleys, available from stock to fit all popular pulley sizes.





Idlers

*Prolong Idler Service Life and Reduce Conveyor Operating Costs with **Martin** Idlers*

Martin idlers are manufactured to exceed CEMA standards. *Martin* uses triple labyrinth seals and sealed-for-life ball bearings that allow for trouble-free idler life in the harshest of applications. *Martin* can provide complete, cost-saving solutions for your belt conveyor needs.

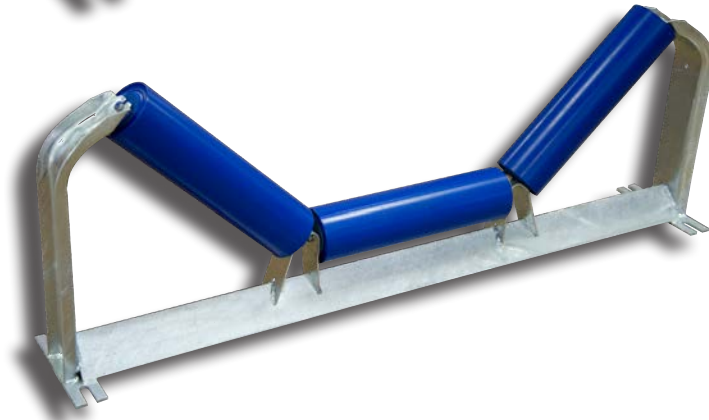
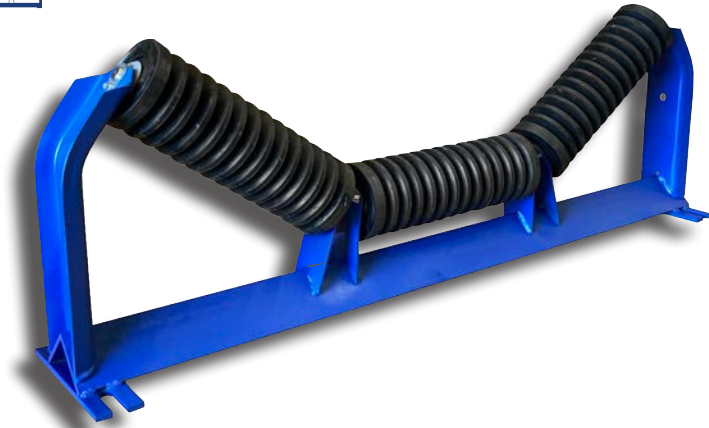

IMPACT IDLERS 

TROUGHING IDLERS 

SELF-ALIGNING IDLERS 

RETURN IDLERS 

FLAT CARRIERS 

IMPACT BEDS 

GALVANIZED FRAMES 

MADE-TO-ORDER



Martin

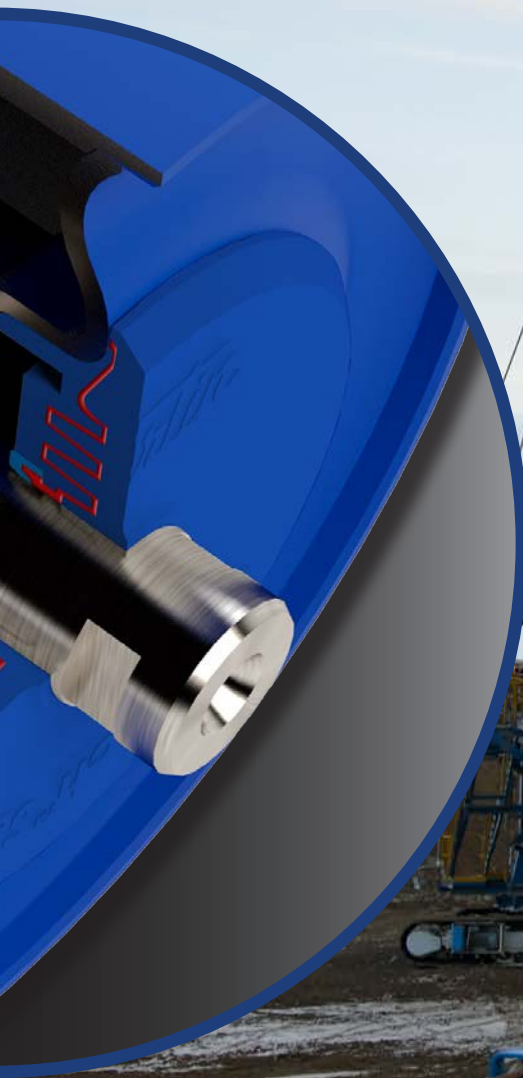

Martin

BODY & FENDER HAMMERS †

BODY & FENDER PICKS †

BODY & FENDER SPOONS †

BODY & FENDER DOLLIES 🛠

HAMMERS †

WRENCHES †

SOCKETS 🛠

SCREW DRIVERS †

PUNCHES & CHISELS †

OTHER TOOLS 🛠



🛠🛠🛠 Body & Fender Tools

Drawing from decades of experience serving the automobile repair industry, *Martin* is proud to supply American-made body hammers, dolly blocks, body picks, tool sets, files and more. *Martin* delivers quality tools that stand up to the toughest of body and fender repair tasks.



Industrial Hand Tools

Continuing a Tradition of Quality Tools You Can Rely On



Industrial Hand Tools

Continuing a tradition of American tool manufacturing, *Martin* is proud to produce high-quality, durable industrial hand tools, sockets, wrenches, hammers, pliers, screwdrivers, punches, chisels, and master sets that withstand frequent use.



Custom Capabilities

SINTERED METAL

INJECTION MOLDING

PLASTIC MILLING

FORGINGS

CASTINGS

WATER JET

LASER CUTTING



Martin

Martin offers a wide range of manufacturing processes to meet any custom need. *Martin* can fabricate, cast, forge, sinter and injection mold to almost any custom specification as well as any secondary operations. This helps eliminate the need for multiple vendors and reduces production time, which leads to substantial cost savings for your organization.

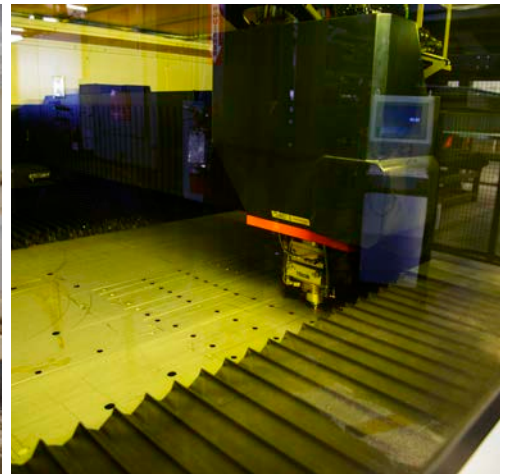





Global Strength, Local Service

During our years serving the power transmission & material handling industries, *Martin* has built a reputation on quality service. Our experienced industry professionals have a deep understanding of the regional and market nuances of the territory they serve.

We believe it should be easy to reach a knowledgeable, dedicated person who is ready to help. Whether it is training at our facility, a meeting in your office, or an on-site analysis at a plant – the *Martin* team is ready to help you increase uptime and cost savings.

Market Expertise

Martin's extensive product line addresses the ever-changing needs of a wide variety of industries throughout the world. *Martin* employs leading experts in each industry and continually innovates to deliver value-added solutions that minimize downtime, reduce maintenance costs, and solve countless other daily operational challenges.

AGRICULTURE

ALTERNATIVE ENERGY

BEVERAGE BOTTLING

CHEMICAL PROCESSING

COMMERCIAL CONSTRUCTION

ENVIRONMENTAL

FOOD PROCESSING

FOREST & WOOD PRODUCTS

HIGHWAY & TRANSPORTATION

HVAC

MINING

OIL & GAS

PACKAGING

PHARMACEUTICAL

PULP & PAPER

RENDERING

WASTEWATER

AND MANY MORE

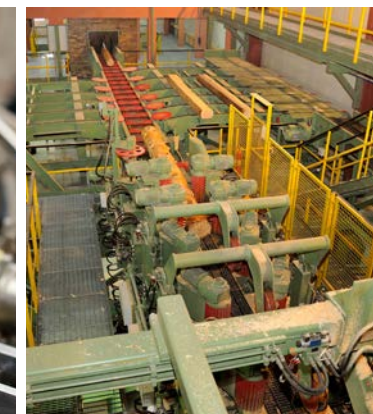
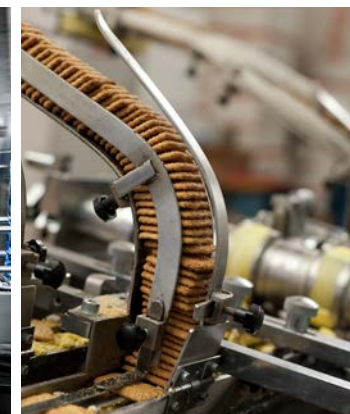

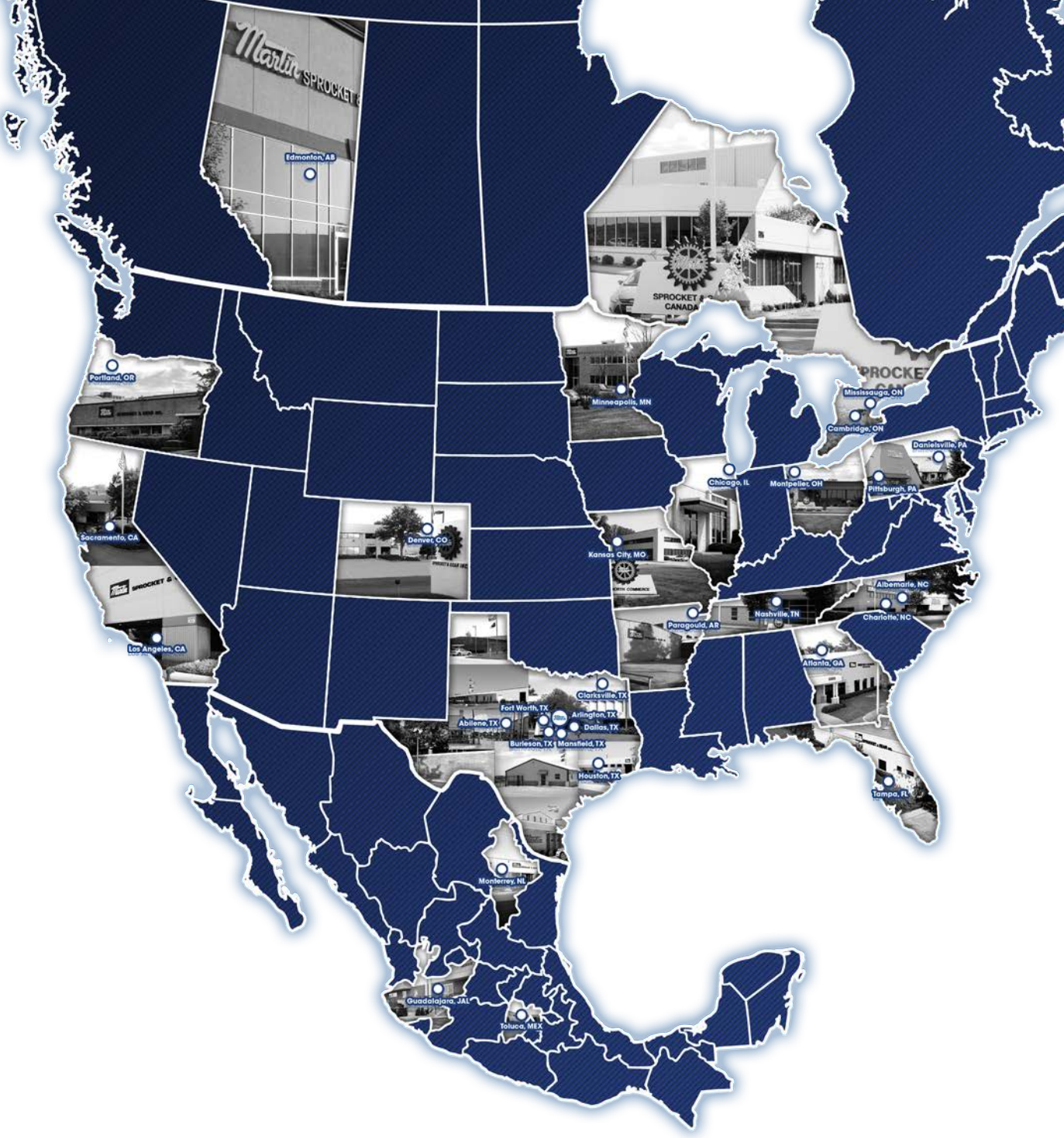

Locations

Since its founding in Arlington, Texas in 1951, *Martin* has grown to more than 34 locations worldwide. These manufacturing and sales branches are strategically located to offer same-day or next-day service anywhere in North America.

Working with your local *Martin* branch connects you with a vast network of experienced sales, engineering, manufacturing and service focused industrial experts.

These branches carry extensive inventories of power transmission and material handling parts for quick alterations. Made to order parts and components are produced regionally for quick delivery in emergency situations.

Our organization may be global, but we are still proud of our local approach to service and quality. From the first phone call to final inspection, your order is treated with a sense of urgency and is hand inspected during each manufacturing process.

When downtime is not an option, Martin is the ONE to rely on.



There is much to know about *Martin* products, capabilities, strengths and advantages, that is why we have prepared this training as an initial introduction to the world of *Martin*, we hope it becomes a tool to strengthen your knowledge of our products.

You can enroll to our available trainings by visiting martinsprocket.com under resources. We look forward to your feedback, and for any inquiries please contact us at DSSP@martinsprocket.com.

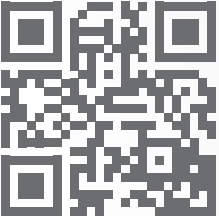

- POWER TRANSMISSION
- MATERIAL HANDLING
- INDUSTRIAL MARKET SERIES
- MAINTENANCE & TROUBLESHOOTING
- MULTI-LANGUAGE



CHALLENGE

What problem is our customer facing?

SOLUTION

How did we help our customer solve the problem?

IMPACT

How much money did we help our customer save?



Industry: Mining

- A major North American Mining manufacturer was having trouble installing a new drive on an existing shaftless screw conveyor.
- *Martin* determined they required a new drive shaft in order to install the new type of reducer.

Documented Cost Savings - \$126,367



Martin Reduces Costs with Material Handling Solutions

Screw Conveyors are the ideal solution for hard to transport materials ranging from irregularly shaped dry solids such as scrap wood and metals, to semi-liquid and sticky materials including pulp, compost, food processing refuse, hospital waste, and wastewater products.

Conveyors can be designed and manufactured using a variety of standard and non-standard materials to fit any custom application.

Screw conveyor products are available as individual or loose components or complete, shop-tested and assembled solutions to fit both existing and new applications.

Challenge

- A major North American Mining manufacturer was having trouble installing a new drive on an existing shaftless screw conveyor.

Solution

- *Martin* sales representatives went on-site to help troubleshoot the problem they were having. After inspection, it turned out that they required a new drive shaft in order to install the new reducer on their drive.
- *Martin* also took the Mining manufacturer's drive unit to their facility so they could mount the drive shaft to the drive unit and replace an end plate for easy on-site installation.

Impact

- Standard lead time for this is 20 workdays, however the Mining manufacturer was in dire need of this drive unit to avoid a costly shutdown. *Martin* was able to provide the drive unit assembly with a new drive shaft and end plate in 4 days resulting in savings of over \$126,000.



Bottom-Line Results

Downtime Avoidance

(\$2,575.22 Downtime Cost per Hour x 50.00 Potential Downtime Hours x 1 Line)

Downtime Avoidance Savings

\$126,367

Learn more about *Martin* and Power Transmission & Material Handling solutions at:

martinsprocket.com • 817.258.3000

Documented cost savings, or DCS, are important to our business. When you provide a clear and concise document, using formulas and customer provided figures, explaining how you saved your customer money, that is a documented cost savings.

A DCS shows the customer that *Martin* is not only here to provide excellent service, such as after-hour service for stock, altered and made to order parts, but also to train employees, reduce downtime, cut costs and increase productivity to raise their revenue.

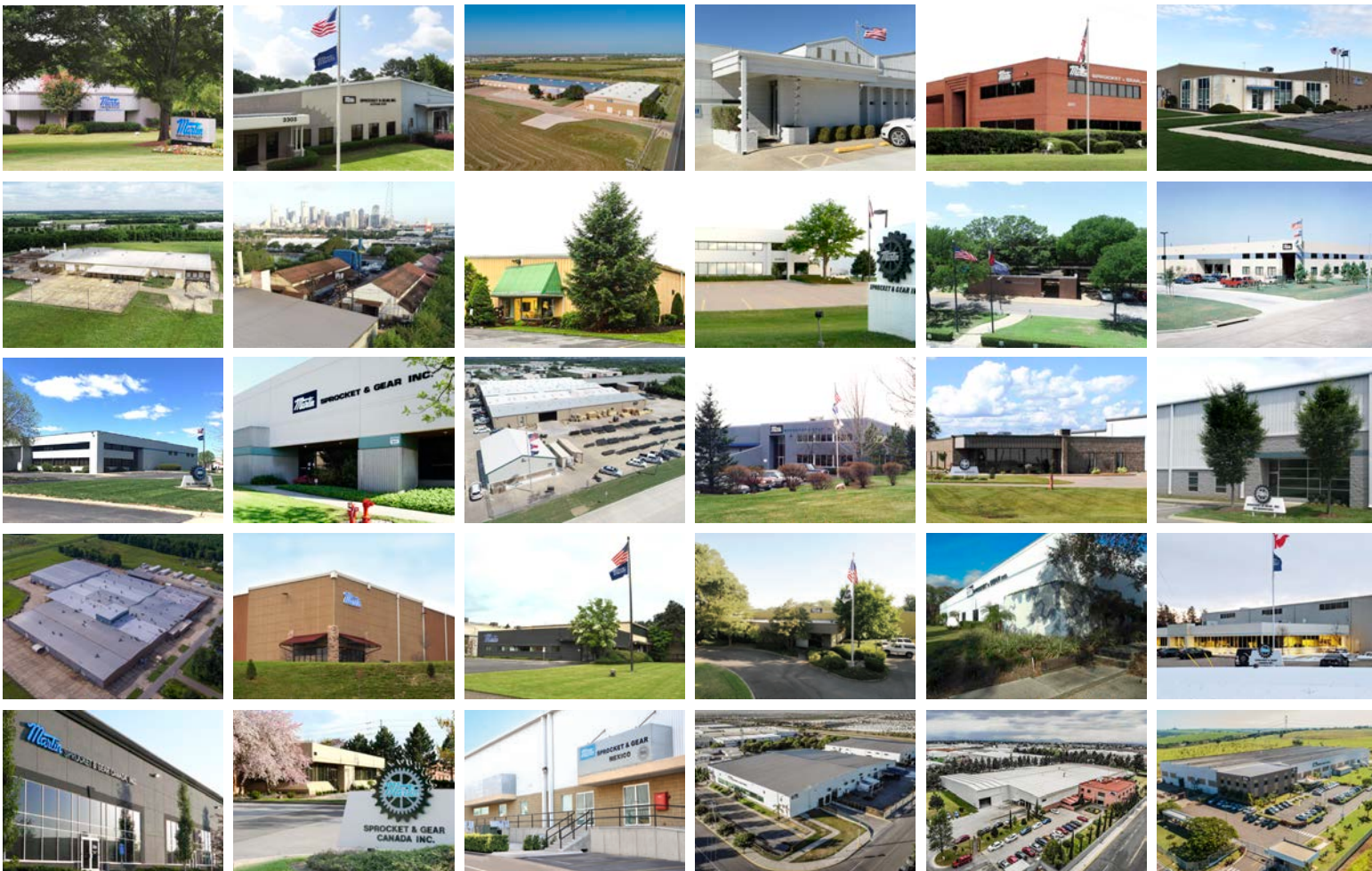

USA Corporate Offices Sales & Manufacturing

Arlington, TX
817-258-3000 (FAX 817-258-3333)

Regional Manufacturing Plants

Albemarle, NC
704-982-9555 (FAX 704-982-9599)
Atlanta, GA
404-292-8744 (FAX 404-292-7771)
Burleson, TX
817-295-7151 (FAX 817-447-3840)
Danielsville, PA
610-837-1841 (FAX 610-837-7337)
Ft. Worth, TX
817-258-3000 (FAX 817-258-3173)
Montpelier, OH
419-485-5515 (FAX 419-485-3565)
Sacramento, CA
916-441-7172 (FAX 916-441-4600)

Branch Manufacturing Plants

Charlotte, NC
704-394-9111 (FAX 704-394-9122)
Chicago, IL
847-298-8844 (FAX 847-298-2967)
Denver, CO
303-371-8466 (FAX 303-371-7116)
Houston, TX
713-849-4330 (FAX 713-849-4807)
Kansas City, MO
816-231-5575 (FAX 816-231-1959)
Los Angeles, CA
323-728-8117 (FAX 323-722-7526)
Minneapolis, MN
952-829-0623 (FAX 952-944-9385)
Nashville, TN
615-871-4730 (FAX 615-871-4125)
Pittsburgh, PA
724-452-4555 (FAX 724-452-5794)
Portland, OR
503-223-7261 (FAX 503-221-0203)
Tampa, FL
813-623-1705 (FAX 813-626-8953)

Manufacturing Only

Abilene, TX • Clarksville, TX • Dallas, TX
Mansfield, TX • Paragould, AR

CANADA

Cambridge, Ontario
519-621-0546 (FAX 519-621-4413)
Edmonton, Alberta
780-450-0888 (FAX 780-465-0079)
Mississauga, Ontario
905-670-1991 (FAX 905-670-2110)

MEXICO

Guadalajara, JAL
+52 333-283-1188 (Fax +52 333-271-8450)
Monterrey, N.L.
+52 811-156-6830 (FAX +52 811-156-6833)
Toluca, MEX
+52 722-276-0800 (Fax +52 722-276-0801)

BRAZIL

São Paulo, SP
+55 19-3877-9400 (Fax +55 19-3877-9429)